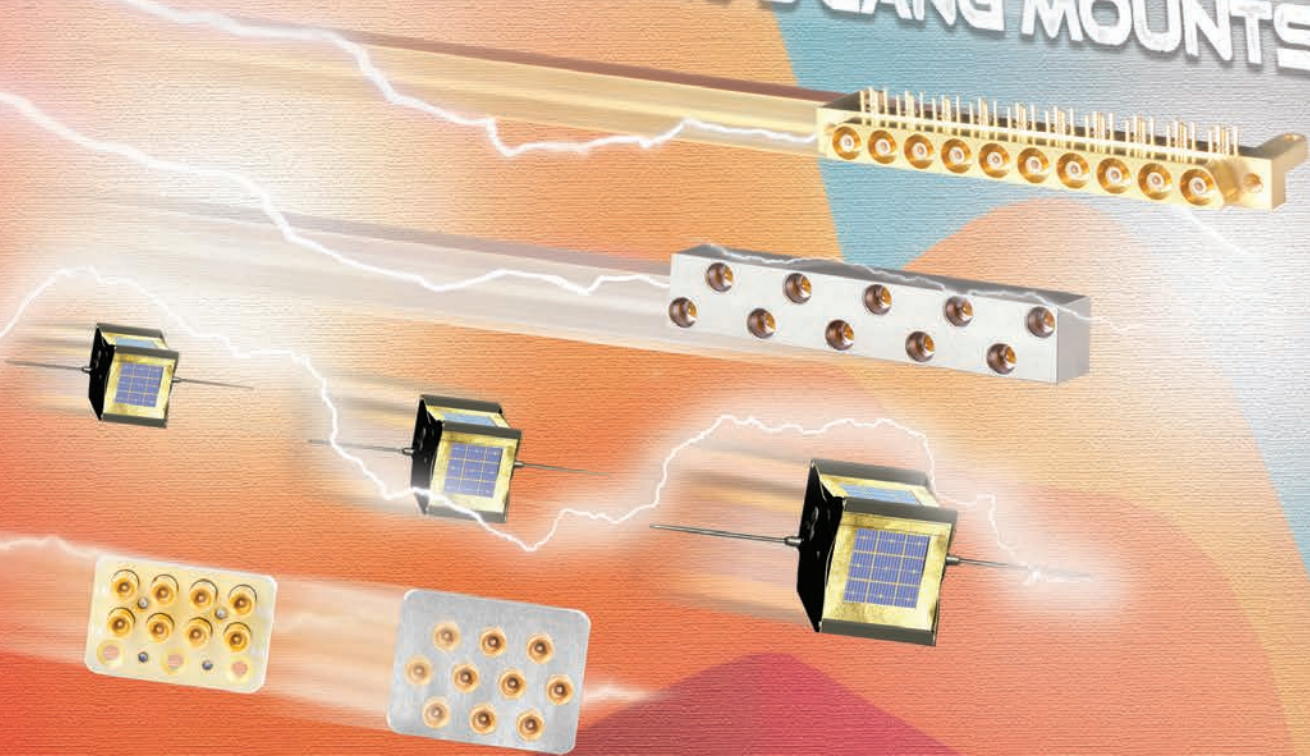




# DELTA

Electronics Mfg. Corp.

## SMP, SMPM, SMP3 GANG MOUNTS

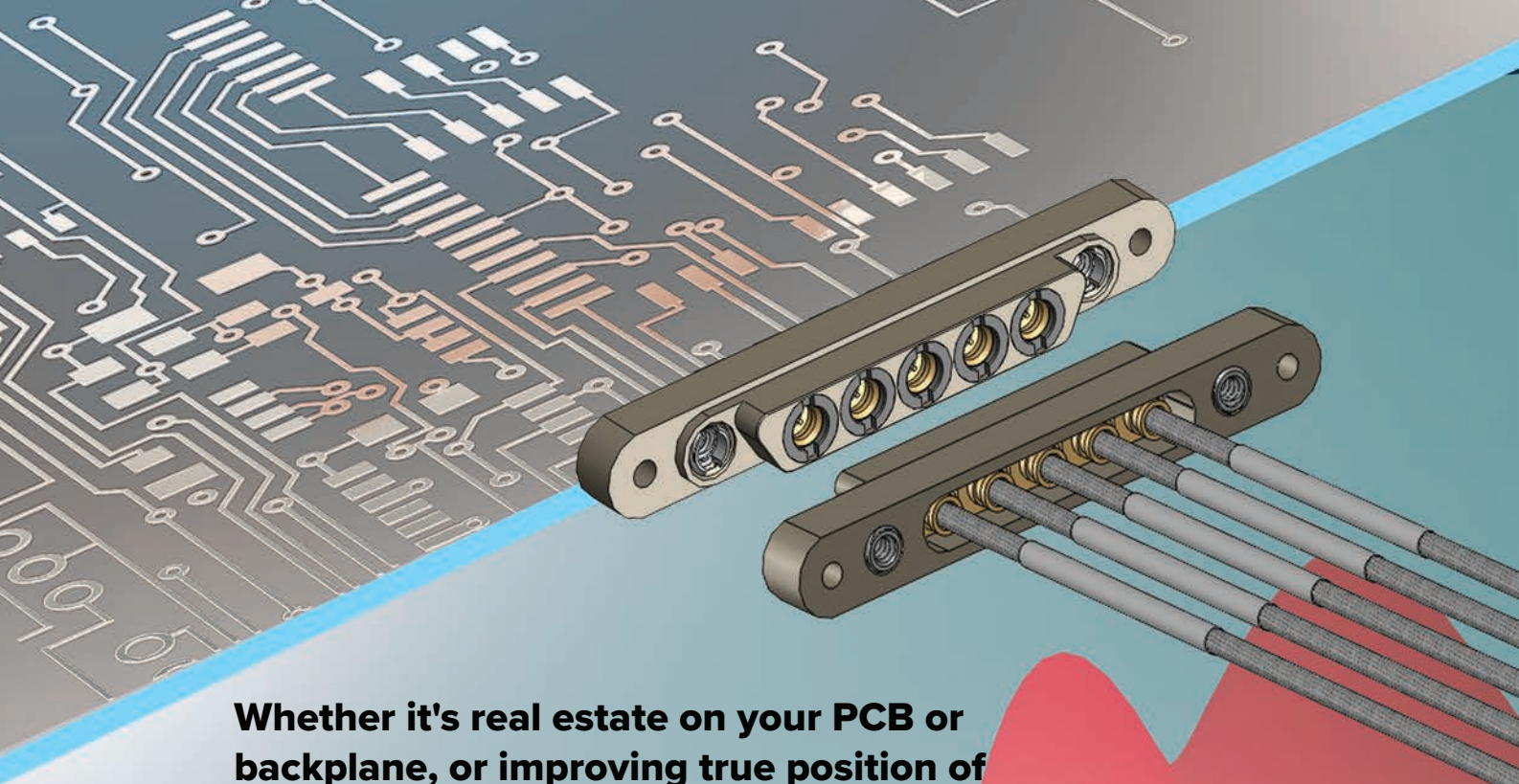


## BLIND MATE RF GANG MOUNTS



[sales@deltarf.com](mailto:sales@deltarf.com) (978) 927-1060 [deltarf.com](http://deltarf.com)





**Whether it's real estate on your PCB or backplane, or improving true position of blind mate RF Interfaces, Delta's ganged RF design solutions are the answer.**

## **Features and Benefits of SMPM-G Gang Mounts**

Ideal for blind mate applications: cable-to-board, cable-to-cable and board-to-board mechanical schemes.

Delta's SMPM-G housings are standardized with 2, 3, 4, 5, 6, 7, and 8 port designs.

SMPM-G housings include female cable mount, male cable mount, male PCB edge mount and male PCB vertical launch. SMPM-G RF connectors are available in both straight and right angle configurations.

SMPM-G housings are keyed to prevent improper mating and port locations are laser marked for proper identification.

Delta's SMPM-G RF connectors and housings are gasketed for extreme weather sealing.

SMPM-G RF connectors accommodate both .047" and .086" semi-rigid cable and the flexible equivalents. Custom cable designs may also be available.

Straight cable mount SMPM-G configurations operate up to 65 GHz, right angle cable mount connectors operate up to 26.5 GHz, PCB edge mount and vertical launch configurations operate up to 40 GHz.

The versatile SMPM-G RF connector interface meets the critical interface dimensions of Mil-STD-348 offering proven blind mate performance, with axial and radial float, assuring proper mating.





## Discover Your SMPM-G Gang Mount Solution



# Ports	SMPM-G Cable Mounts Housings	Part Number	Page #
	<b>SMPM-G General Specifications</b>		
<b>2 Port</b>	<b>Female, Cable Mount with Self Captivating Jack Screws</b>	<b>21-10459-02</b>	<b>6-7</b>
<b>2 Port</b>	<b>Male, Cable Mount with Environmental Seal</b>	<b>21-10460-02</b>	<b>10-11</b>
<b>3 Port</b>	<b>Female, Cable Mount with Self Captivating Jack Screws</b>	<b>21-10459-03</b>	<b>6-7</b>
<b>3 Port</b>	<b>Male, Cable Mount with Environmental Seal</b>	<b>21-10460-03</b>	<b>10-11</b>
<b>4 Port</b>	<b>Female, Cable Mount with Self Captivating Jack Screws</b>	<b>21-10459-04</b>	<b>6-7</b>
<b>4 Port</b>	<b>Male, Cable Mount with Environmental Seal</b>	<b>21-10460-04</b>	<b>10-11</b>
<b>5 Port</b>	<b>Female, Cable Mount with Self Captivating Jack Screws</b>	<b>21-10459-05</b>	<b>6-7</b>
<b>5 Port</b>	<b>Male, Cable Mount with Environmental Seal</b>	<b>21-10460-05</b>	<b>10-11</b>
<b>6 Port</b>	<b>Female, Cable Mount with Self Captivating Jack Screws</b>	<b>21-10459-06</b>	<b>6-7</b>
<b>6 Port</b>	<b>Male, Cable Mount with Environmental Seal</b>	<b>21-10460-06</b>	<b>10-11</b>
<b>7 Port</b>	<b>Female, Cable Mount with Self Captivating Jack Screws</b>	<b>21-10459-07</b>	<b>6-7</b>
<b>7 Port</b>	<b>Male, Cable Mount with Environmental Seal</b>	<b>21-10460-07</b>	<b>10-11</b>
<b>8 Port</b>	<b>Female, Cable Mount with Self Captivating Jack Screws</b>	<b>21-10459-08</b>	<b>6-7</b>
<b>8 Port</b>	<b>Male, Cable Mount with Environmental Seal</b>	<b>21-10460-08</b>	<b>10-11</b>

Gender	SMPM-G Cable Mount RF Connectors	Part Number	Page #
<b>Female</b>	<b>Straight Cable Mount Female for .086" (RG 405) SR or Flex</b>	<b>8808094G003-005</b>	<b>8</b>
<b>Female</b>	<b>Right Angle Cable Mount Female for .086" (RG 405) SR or Flex</b>	<b>8876094G003-011</b>	<b>9</b>
<b>Female</b>	<b>Straight Cable Mount Female for .047" (RG 405) SR or Flex</b>	<b>8808111G003-006</b>	<b>8</b>
<b>Female</b>	<b>Right Angle Cable Mount Female for .047" (RG 405) SR or Flex</b>	<b>8876111G003-007</b>	<b>9</b>
<b>Male</b>	<b>Straight Cable Mount Male for .086" (RG 405) SR or Flex</b>	<b>8801094G003-001</b>	<b>12</b>
<b>Male</b>	<b>Right Angle Cable Mount Male for .086" (RG 405) SR or Flex</b>	<b>8872094G903-004</b>	<b>13</b>
<b>Male</b>	<b>Straight Cable Mount Male for .047" (RG 405) SR or Flex</b>	<b>8801111G003-004</b>	<b>12</b>
<b>Male</b>	<b>Right Angle Cable Mount Male for .047" (RG 405) SR or Flex</b>	<b>8872111G903-000</b>	<b>13</b>



# Ports	SMPM-G PCB Vertical Launch Housings	Part Number	Page #
2 Port	Male, Vertical Launch, SB, PCB Mount with 4-40 UNC-2B screws	8869000G91P-101	14-15
3 Port	Male, Vertical Launch, SB, PCB Mount with 4-40 UNC-2B screws	8869000G91P-102	14-15
4 Port	Male, Vertical Launch, SB, PCB Mount with 4-40 UNC-2B screws	8869000G91P-103	14-15
5 Port	Male, Vertical Launch, SB, PCB Mount with 4-40 UNC-2B screws	8869000G91P-104	14-15
6 Port	Male, Vertical Launch, SB, PCB Mount with 4-40 UNC-2B screws	8869000G91P-105	14-15
7 Port	Male, Vertical Launch, SB, PCB Mount with 4-40 UNC-2B screws	8869000G91P-106	14-15
8 Port	Male, Vertical Launch, SB, PCB Mount with 4-40 UNC-2B screws	8869000G91P-049	14-15

# Ports	SMPM-G PCB Edge Launch Housings	Part Number	Page #
2 Port	Male, Edge Launch, SB, PCB Mount with 4-40 UNC-2B screws	8869000G91P-095	16-17
3 Port	Male, Edge Launch, SB, PCB Mount with 4-40 UNC-2B screws	8869000G91P-096	16-17
4 Port	Male, Edge Launch, SB, PCB Mount with 4-40 UNC-2B screws	8869000G91P-097	16-17
5 Port	Male, Edge Launch, SB, PCB Mount with 4-40 UNC-2B screws	8869000G91P-098	16-17
6 Port	Male, Edge Launch, SB, PCB Mount with 4-40 UNC-2B screws	8869000G91P-099	16-17
7 Port	Male, Edge Launch, SB, PCB Mount with 4-40 UNC-2B screws	8869000G91P-100	16-17
8 Port	Male, Edge Launch, SB, PCB Mount with 4-40 UNC-2B screws	8869000G91P-048	16-17

SMPM-G PCB Cable Assembly & Tooling	Part Number	Page #
Cable Assembly Options	.040 / .047 / .086 Cable	18-19
More Gang Mount Options	SMP-G / SMP3-G / VITA	20-24
SMPM-G Extras	Bullet Adapters & Tools	25





<b>SMPM-G Electrical Specifications</b>	
<b>Operating Frequency - SMPM-G RF Connectors</b>	
Straight Cable Mount - DC to 65 GHz	
R/ A Cable Mount - DC to 26.5 GHz	
Verical Launch PCB Mount - DC to 40 GHz	
R/ A Edge Launch PCB Mount - DC to 40 GHz	
<b>Impedance</b>	
Straight and Right Angle - 50 Ω	
<b>Insertion Loss</b>	
05 +.04√f in GHz (non hermetic connectors)	
<b>VSWR (Voltage Standing Wave Ratio)</b>	
1.35:1 Max. thru 26.5 GHz; 1.4 Max. thru 65 GHz	
<b>RF Leakage</b>	
-80 db to 3 GHz, -65 db to 65 GHz	
<b>Insulation Resistance</b>	
5,000 megohms	
<b>DWV (@ sea level)</b>	
500 Vrms	

<b>SMPM-G Environmental Specifications</b>	
<b>Temperature Range</b>	
-65 C to + 165 C	
<b>Mechanical Shock</b>	
Meets Mil-STD-202, Method 213,	
<b>Random Vibration</b>	
Meets MIL-STD-202, Method 214, Condition K-I, 46.3 g	
<b>Sine Vibration</b>	
MIL-STD-202, method 204, 28 g peak	
<b>Altitude</b>	
Meets Mil-STD-202, Method 105, Condition C	
<b>Thermal Shock</b>	
Meets Mil-STD-202, Method 107, Condition B	
<b>Moisture Resistance</b>	
MIL-STD-202, Method 106	

<b>SMPM-G Mechanical Specifications</b>	
<b>Force to Engage</b>	
Smooth Bore • 2.0 lbs Typical	
Limited Detent - 3.5 lbs Typical	
Full Detent - 5.0 lbs Typical	
<b>Force to Disengage</b>	
Smooth Bore 1.5 lbs Typical	
Limited Detent - 4.0 lbs Typical	
Full Detent • 6.0 lbs Typical	
<b>Durability</b>	
Smooth Bore • 1000 cycles	
Limited Detent • 500 cycles	
Full Detent - 100 cycles	
<b>Contact Retention</b>	
1.5 lbs Min	
<b>Axial Misalignmnet</b>	
.010"	
<b>Radial Misalignmnet</b>	
+/- .010	

<b>SMPM-G Materials &amp; Plating Specifications</b>	
<b>Materials - RF Connector</b>	
Bodies • Beryllium Copper per ASTM B196 and/or ASTM B 197 or Stainless Steel, type 303, Condition A	
Outer & Center Contacts • Beryllium Copper per ASTM B196	
Insulators • PTFE Fluorocarbon per ASTM D1710, type 1, grade 1; Torlon per ASTMD-5204 or Ultem per ASTM D-5205	
<b>Materials - Housing</b>	
Block Housing • Brass per ASTM B16, C36000 Alloy, Temper H02	
Gasket - Silicone Rubber per A-A-59588	
Hardware - 18-8 Stainless Steel, 316L Stainless Steel	
<b>Plating - RF Connectors</b>	
Bodies • Gold Plate per ASTM B488, over Nickel Plate, per SAE AMS-QQ-N-290 or Passivated per SAE AMS 2700	
Outer Contacts • Gold Plate per MIL-G-45204, over Nickel Plate per SAE - AMS-QQ-N-290	
Center Contacts • Gold Plate per ASTM B488, type II, over Nickel Plate, per SAE AMS-QQ-N-290	
<b>Plating - Housing</b>	
Housing • Nickel Plate per SAE-AMS-QQ-N-290	

Note: Mechanical dimensions are for reference only.  
Please contact Delta's engineering or customer  
service representatives for production drawings.





**Military**



**Launch  
Vehicles**

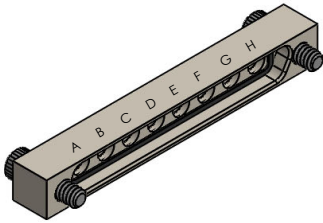


**High Speed  
Computing**



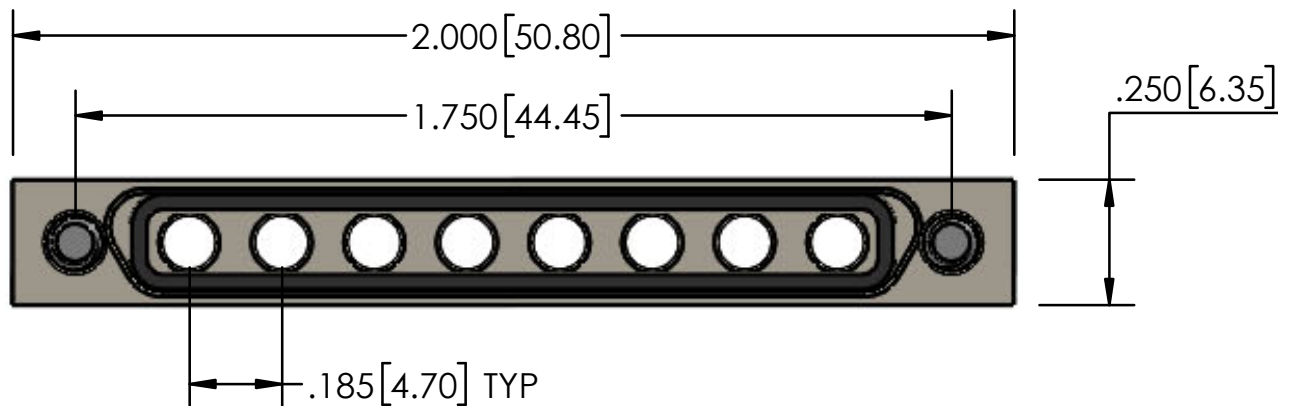
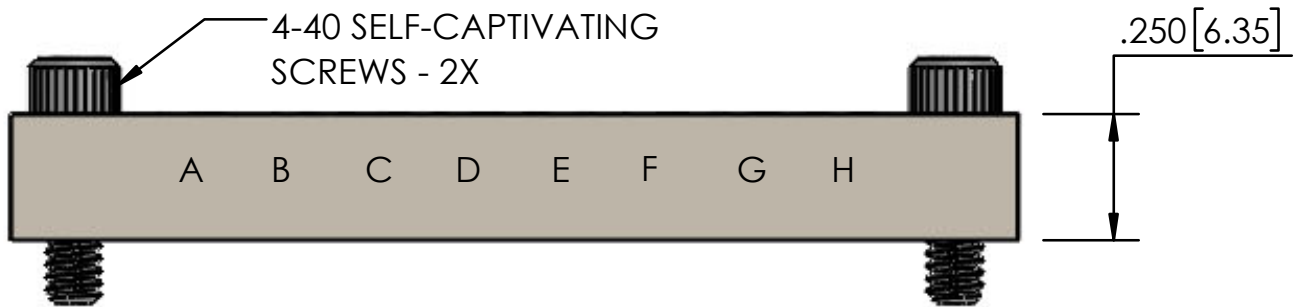
**Radar  
Applications**





**SMPM-G 21-10459-08 Female Cable Mount**  
 Straight Cable Mount Female, 8 port, with 4-40 UNC Self Captivating Jack Screws. Each port is laser marked for quick identification and the environmentally sealed housing accepts Delta's straight & right angle cable mount SMPM connectors.

Part Number	Configuration	Cable	Gender	Connectors
<b>21-10459-08</b>	Cable Mount	.047" .086" (RG 405) SR or Flex	Female	Straight & Right Angle
Product Features				
Housing Material	Brass	Interface Seal Material	Silicone Rubber	
Housing Plating	Nickel	Port Identifiers	Laser Marked A-H	
Hardware Material	Steel	Distance Between Ports	.185"	
Hardware Plating	Passivated	Block Height & Width	.250"	



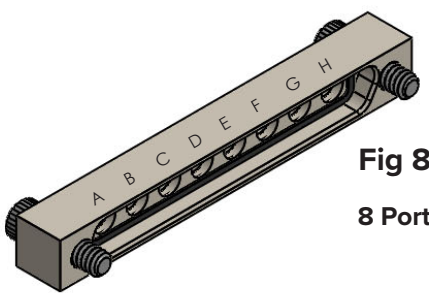
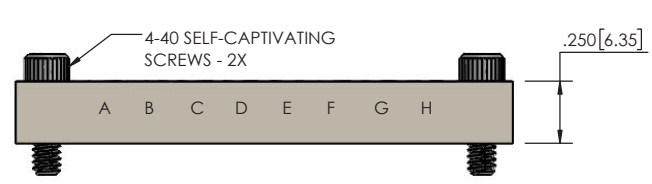
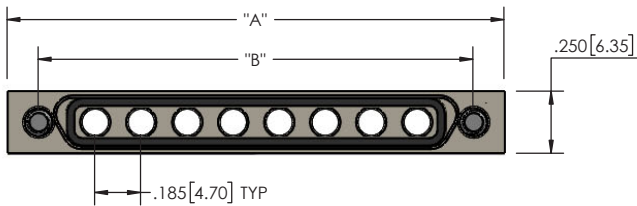
# GANG MOUNT SMPM-G FEMALE HOUSING CABLE MOUNT



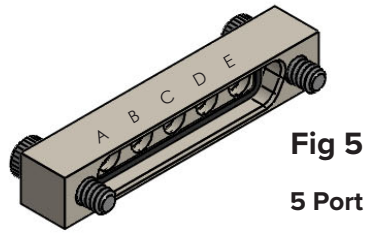
## Dimensions For 2 Port Thru 8 Port

Distance Between All Ports: .185" TYP Height & Width All Blocks .250" TYP

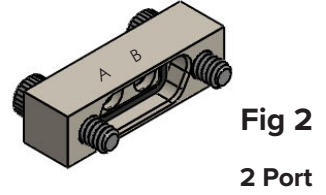
Delta Part #	A	B	Ports	Delta Part #	A	B	Ports
Fig 2 - 21-10459-02	0.890	0.640	2	Fig 6 - 21-10459-06	1.630	1.380	6
Fig 3 - 21-10459-03	1.075	0.825	3	Fig 7 - 21-10459-07	1.815	1.565	7
Fig 4 - 21-10459-04	1.260	1.010	4	Fig 8 - 21-10459-08	2.000	1.750	8
Fig 5 - 21-10459-05	1.445	1.195	5				



**Fig 8**  
8 Port

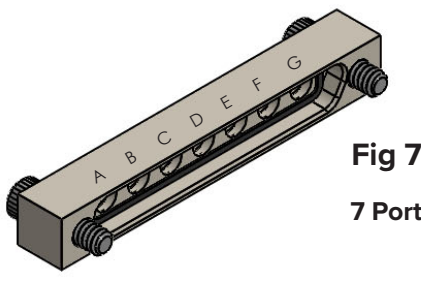


**Fig 5**  
5 Port

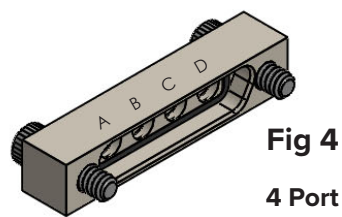


**Fig 2**  
2 Port

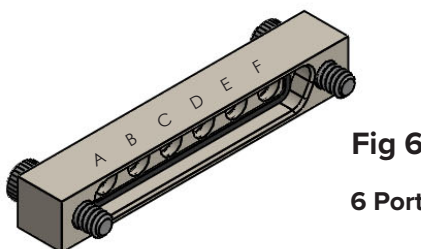
**Straight & Right  
Angle SMPM-G RF  
Connectors  
Pages 8 & 9.**



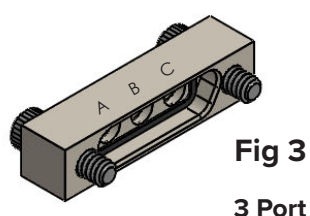
**Fig 7**  
7 Port



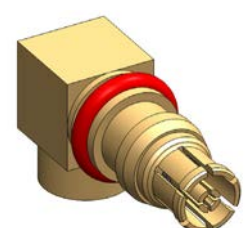
**Fig 4**  
4 Port



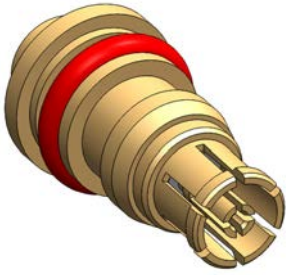
**Fig 6**  
6 Port



**Fig 3**  
3 Port

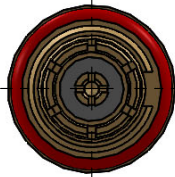
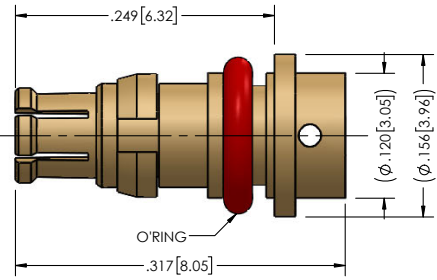


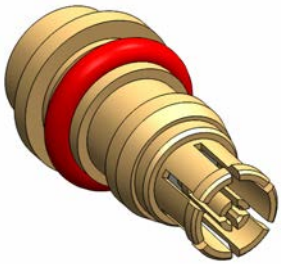




### SMPM-G 8808094G003-005

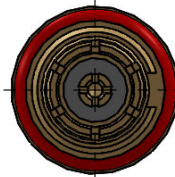
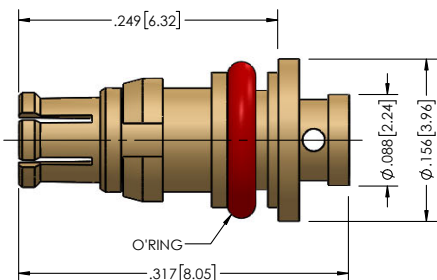
Straight Cable Mount Female for .086" (RG 405) Semi-Rigid or the flexible equivalent, snaps into male cable mount housing, reference Delta housing Part # 21-10459-08

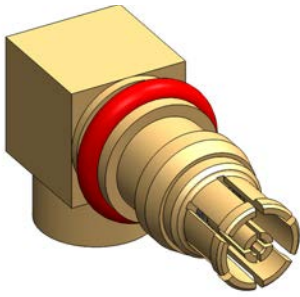
Part Number	Configuration	Cable	CC Termination	OC Termination
<b>8808094G003-005</b>	Straight	.086" (RG-405) SR or Flex	One-Step (solderless)	Direct Solder
<b>Product Features</b>				
Frequency	65 GHz			
CC Gender	Female			
Durability	1000 Cycles			
CC & Body Material	Be Cu			
CC & Body Plating	Gold			
Insulator	PTFE			
				



### SMPM-G 8808111G003-006

Straight Cable Mount Female for .047" Semi-Rigid or the flexible equivalent, snaps into male cable mount housing, reference Delta housing Part # 21-10459-08

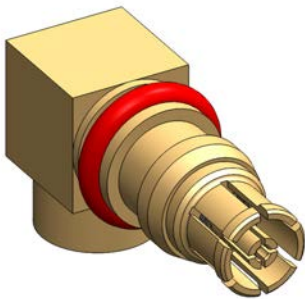
Part Number	Configuration	Cable	CC Termination	OC Termination
<b>8808111G003-006</b>	Right Angle	.047" SR or Flex	One-Step (solderless)	Direct Solder
<b>Product Features</b>				
Frequency	65 GHz			
CC Gender	Female			
Durability	1000 Cycles			
CC & Body Material	Be Cu			
CC & Body Plating	Gold			
Insulator	PTFE			
				



### SMPM-G 8876094G003-011

Right Angle Cable Mount Female for .086" (RG 405) Semi-Rigid or the flexible equivalent, snaps into male cable mount housing, reference Delta housing Part # 21-10459-08

Part Number	Configuration	Cable	CC Termination	OC Termination	
<b>8876094G003-011</b>	Right Angle	.086" (RG-405) SR or Flex	Solder	Direct Solder	
<b>Product Features</b>					
Frequency	26.5 GHz				
CC Gender	Female				
Durability	1000 Cycles				
CC & Body Material	Be Cu				
CC & Body Plating	Gold				
Insulator	PTFE				



### SMPM-G 8876111G003-007

Right Angle Cable Mount Female for .047" Semi-Rigid or the flexible equivalent, snaps into male cable mount housing, reference Delta housing Part # 21-10459-08

Part Number	Configuration	Cable	CC Termination	OC Termination	
<b>8876111G003-007</b>	Right Angle	.047" SR or Flex	Solder	Direct Solder	
<b>Product Features</b>					
Frequency	26.5 GHz				
CC Gender	Female				
Durability	1000 Cycles				
CC & Body Material	Be Cu				
CC & Body Plating	Gold				
Insulator	PTFE				

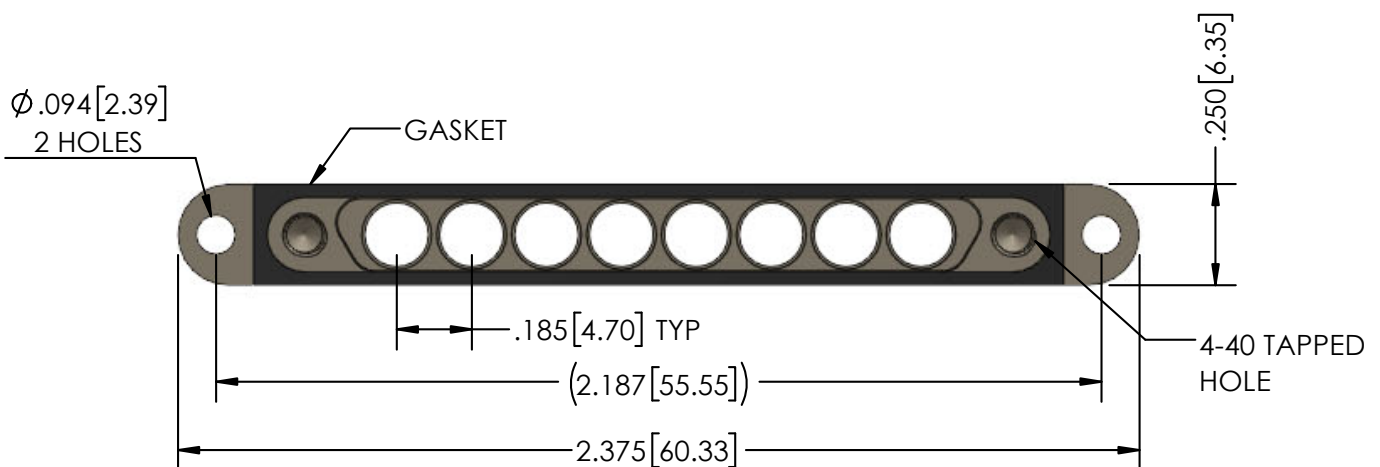
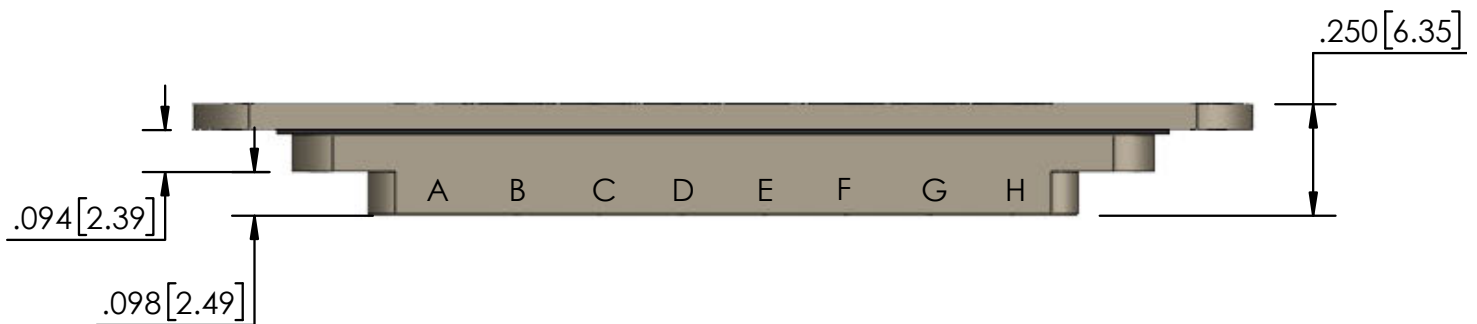




### SMPM-G 21-10460-08 Male Cable Mount

Straight Cable Mount Male, 8 port, with 4-40 UNC-2B thread x .100 Deep, 2 places. Each port is laser marked for quick identification and the environmentally sealed housing accepts Delta's straight & right angle cable mount SMPM connectors.

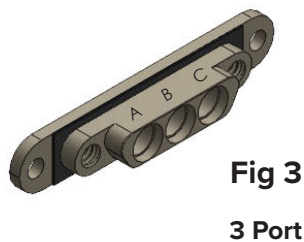
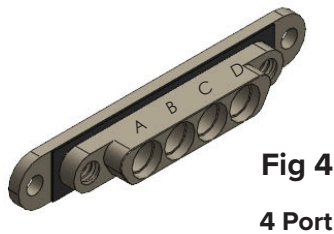
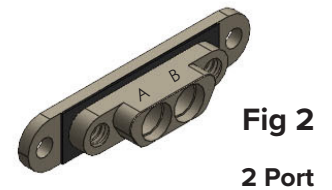
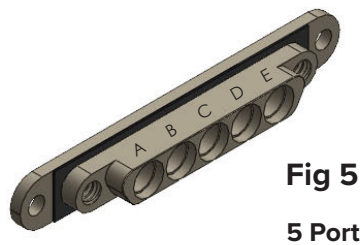
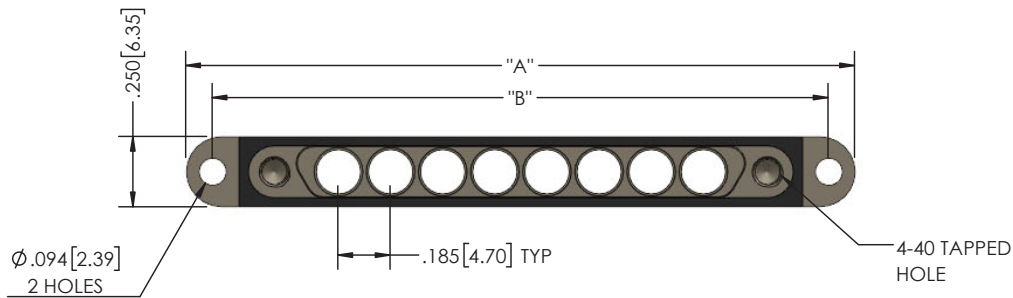
Part Number	Configuration	Cable	Gender	Connectors
<b>21-10460-08</b>	Cable Mount	.047" .086" (RG 405) SR or Flex	Male	Straight & Right Angle
Product Features				
Housing Material	Brass	Interface Seal Material	Silicone Rubber	
Housing Plating	Nickel	Port Identifiers	Laser Marked A-H	
Hardware Material	N/A	Distance Between Ports	.185"	
Hardware Plating	N/A	Block Height & Width	.250"	



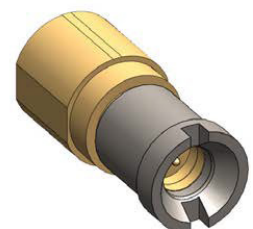
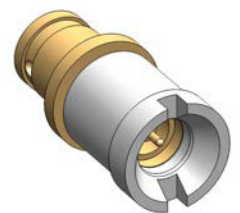
**Dimensions For 2 Port Thru 8 Port**

**Distance Between All Ports: .185" TYP Height & Width All Blocks .250" TYP**

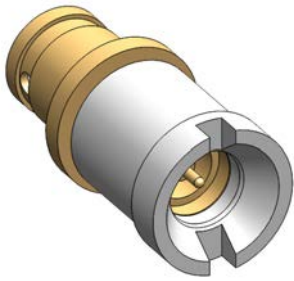
Delta Part #	A	B	Ports	Delta Part #	A	B	Ports
Fig 2 - 8869000G91P-101	1.265	1.077	2	Fig 6 - 8869000G91P-105	2.005	1.817	6
Fig 3 - 8869000G91P-102	1.450	1.262	3	Fig 7 - 8869000G91P-106	2.190	2.002	7
Fig 4 - 8869000G91P-103	1.635	1.447	4	Fig 8 - 8869000G91P-049	2.375	2.187	8
Fig 5 - 8869000G91P-104	1.820	1.632	5				



**Straight & Right  
Angle SMPM-G RF  
Connectors  
Pages 12 & 13.**



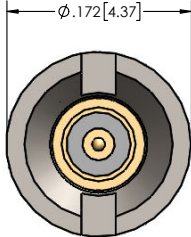


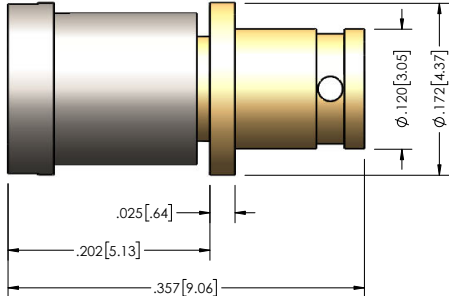


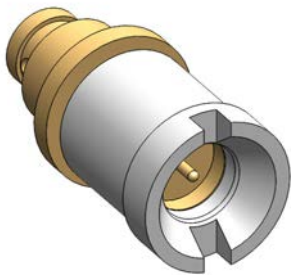
### SMPM-G 8801094G003-001

Straight Cable Mount Male for .086"  
 (RG 405) Semi-Rigid or the flexible equivalent,  
 snaps into male cable mount housing, reference  
 Delta housing Part # 21-10460-08

Part Number	Configuration	Cable	CC Termination	OC Termination
<b>8801094G003-001</b>	Straight	.086" (RG-405) SR or Flex	One-Step (solderless)	Direct Solder
<b>Product Features</b>				
Frequency	65 GHz			
CC Gender	Male			
Durability	1000 Cycles			
CC & Body Material	HT Be Cu			
CC & Body Plating	Gold			
Insulator	PTFE			
Bushing Material	CRS			



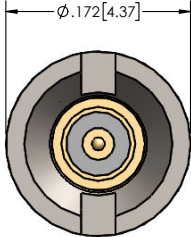


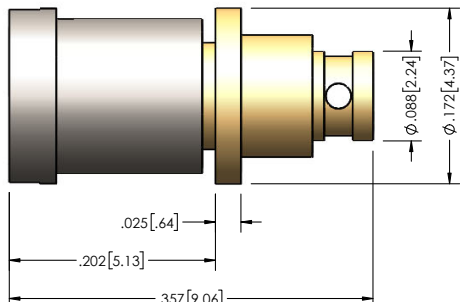


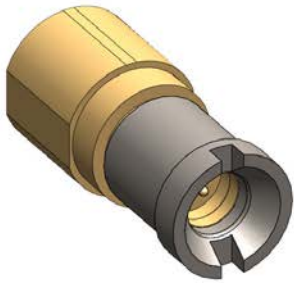
### SMPM-G 8801111G003-004

Straight Cable Mount Male for .047"  
 Semi-Rigid or the flexible equivalent, snaps into  
 male cable mount housing, reference Delta  
 housing Part # 21-10460-08

Part Number	Configuration	Cable	CC Termination	OC Termination
<b>8801111G003-004</b>	Right Angle	.047" SR or Flex	One-Step (solderless)	Direct Solder
<b>Product Features</b>				
Frequency	65 GHz			
CC Gender	Male			
Durability	1000 Cycles			
CC & Body Material	HT Be Cu			
CC & Body Plating	Gold			
Insulator	PTFE			
Bushing Material	CRS			



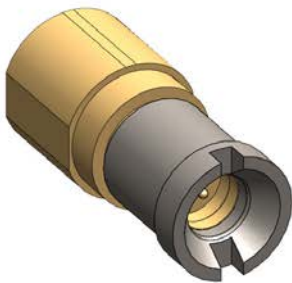




**SMPM-G 8872094G903-004**

Right Angle Cable Mount Male for .086" (RG 405) Semi-Rigid or the flexible equivalent, snaps into male cable mount housing, reference Delta housing Part # 21-10460-08

Part Number	Configuration	Cable	CC Termination	OC Termination
<b>8872094G903-004</b>	Right Angle	.086" (RG-405) SR or Flex	Solder	Direct Solder
<b>Product Features</b>				
Frequency	40 GHz			
CC Gender	Male			
Durability	1000 Cycles			
CC & Body Material	HT Be Cu			
CC & Body Plating	Gold			
Insulator	PTFE			
Bushing Material	CRS			

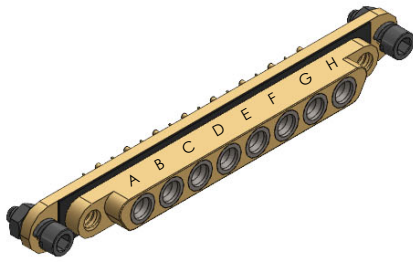


**SMPM-G 8872111G903-000**

Right Angle Cable Mount Male for .047" Semi-Rigid or the flexible equivalent, snaps into male cable mount housing, reference Delta housing Part # 21-10460-08

Part Number	Configuration	Cable	CC Termination	OC Termination
<b>8872111G903-000</b>	Right Angle	.047" SR or Flex	One-Step (solderless)	Direct Solder
<b>Product Features</b>				
Frequency	40 GHz			
CC Gender	Male			
Durability	1000 Cycles			
CC & Body Material	HT Be Cu			
CC & Body Plating	Gold			
Insulator	PTFE			
Bushing Material	CRS			

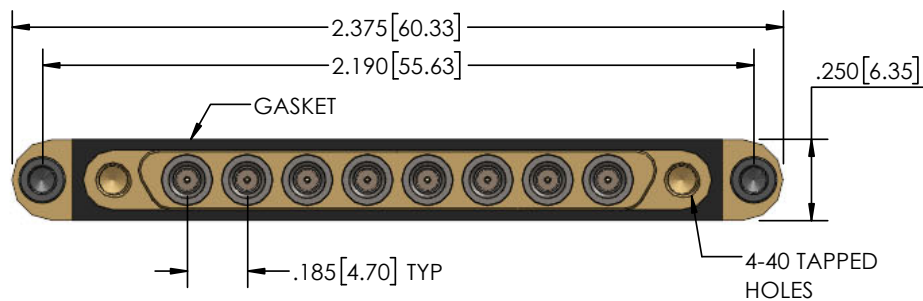
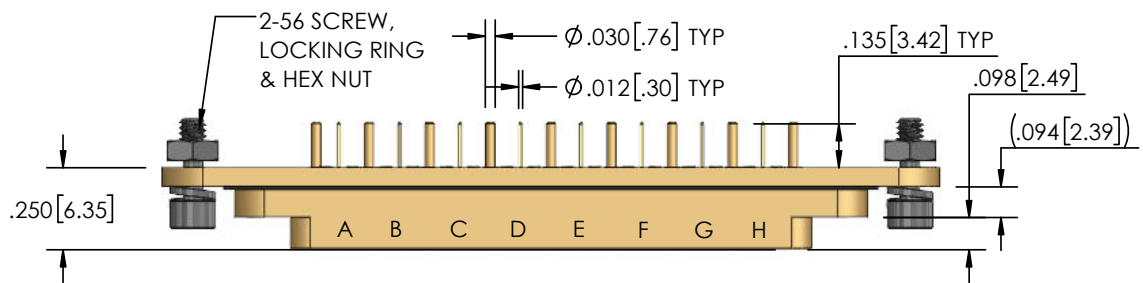




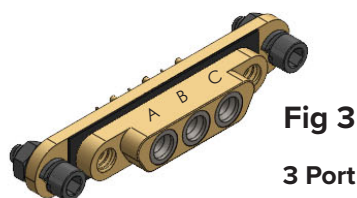
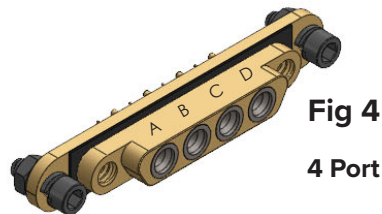
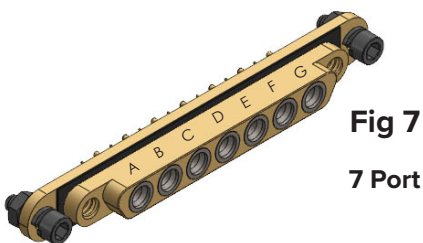
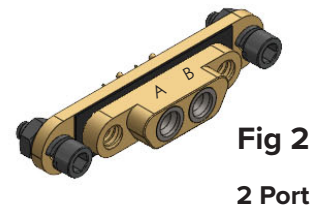
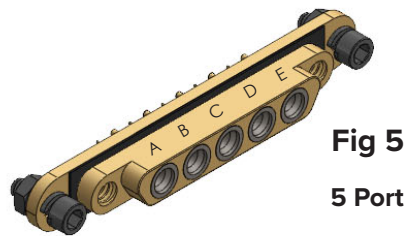
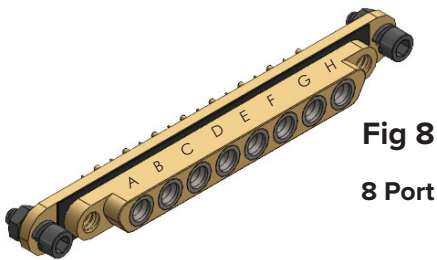
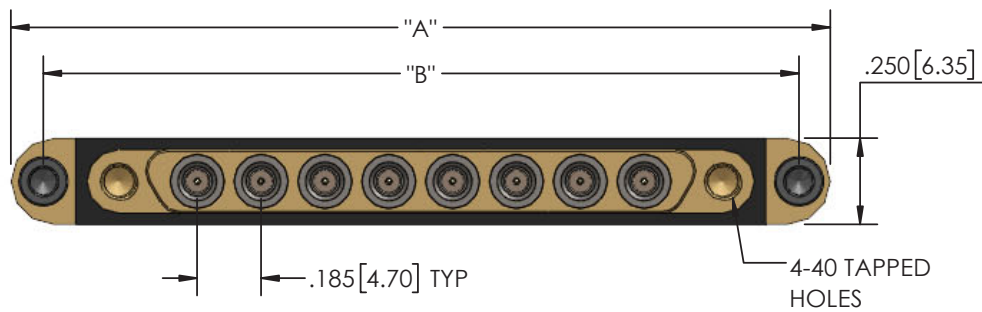
## SMPM-G 8869000G91P-049

8 Port PCB Mount  
 Vertical Launch Male With  
 4-40 UNC-2B Screws

Part Number	Housing Configuration	PCB Mount	CC Termination	OC Termination
<b>8869000G91P-049</b>	Staight	Vertical Launch	Thru Hole	Thru Hole
Product Features				
<b>Housing Material</b>	Brass	<b>Interface Seal Material</b>	Silicone Rubber	
<b>Housing Plating</b>	Gold	<b>Port Identifiers</b>	Laser Marked A-H	
<b>Hardware Material</b>	Steel	<b>Distance Between Ports</b>	.185"	
<b>Hardware Plating</b>	Passivated	<b>Block Height &amp; Width</b>	.250"	



Dimensions For 2 Port Thru 8 Port								
Distance Between All Ports: .185" TYP Height & Width All Blocks .250" TYP								
Delta Part #	A	B	Ports		Delta Part #	A	B	Ports
Fig 2 - 8869000G91P-101	1.265	1.077	2		Fig 6 - 8869000G91P-105	2.005	1.817	6
Fig 3 - 8869000G91P-102	1.450	1.262	3		Fig 7 - 8869000G91P-106	2.190	2.002	7
Fig 4 - 8869000G91P-103	1.635	1.447	4		Fig 8 - 8869000G91P-049	2.375	2.187	8
Fig 5 - 8869000G91P-104	1.820	1.632	5					



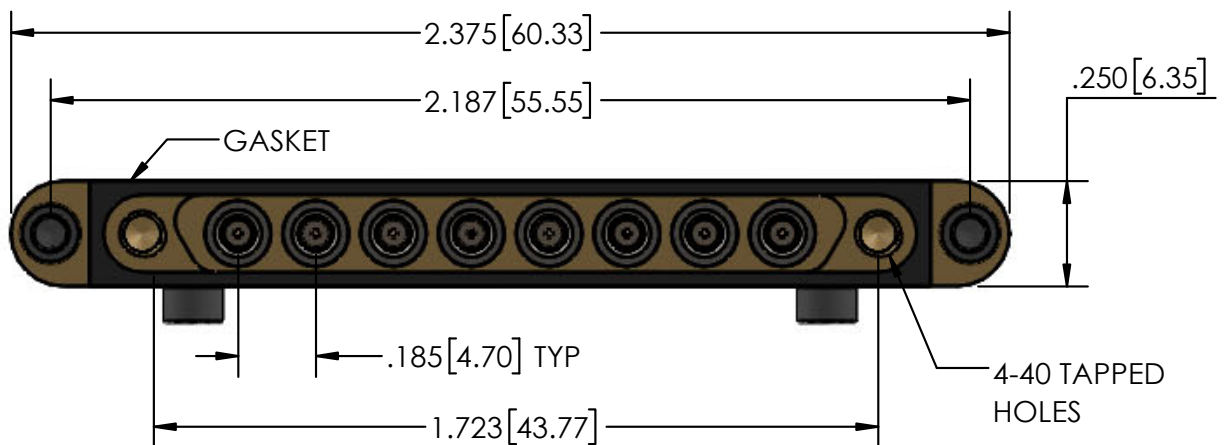
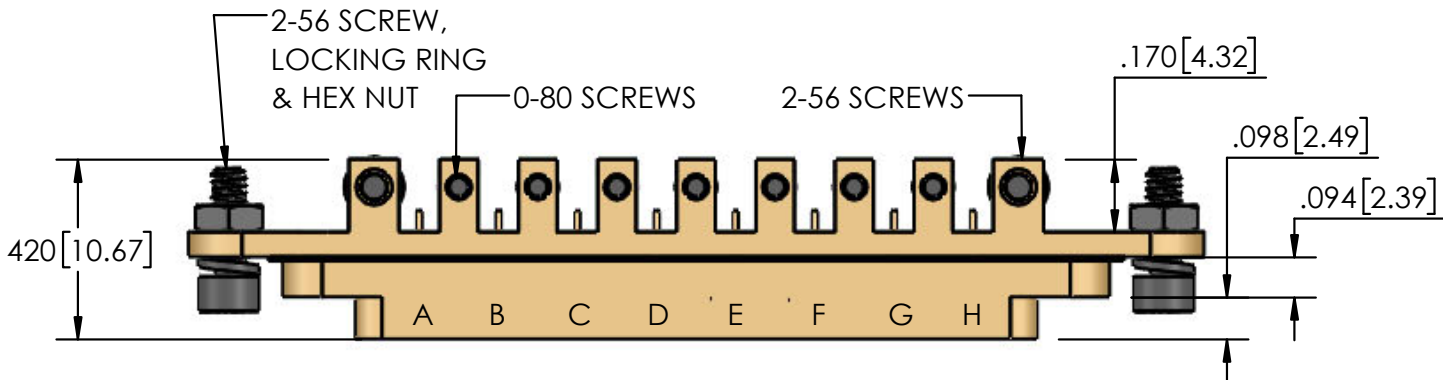




**SMPM-G 8869000G91P-048**

8 Port PCB Mount  
Edge Launch Male With  
4-40 UNC-2B Screws

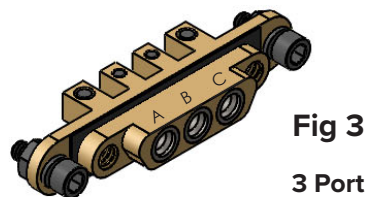
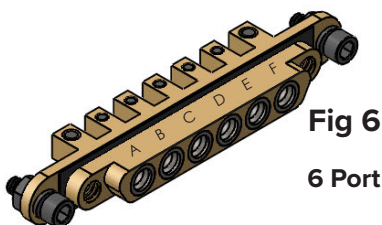
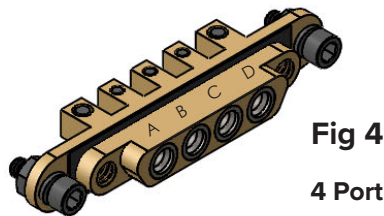
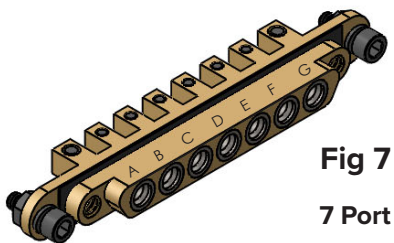
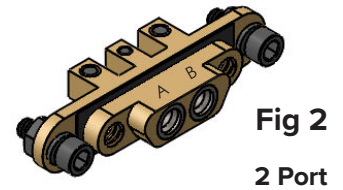
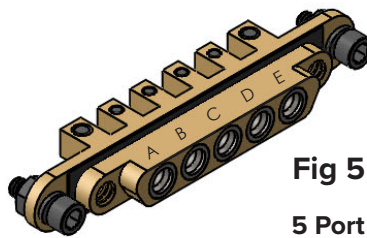
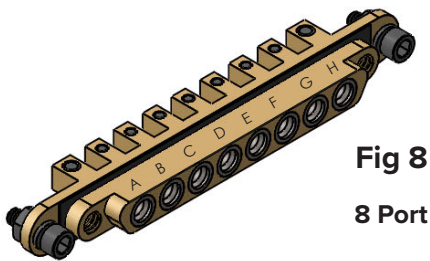
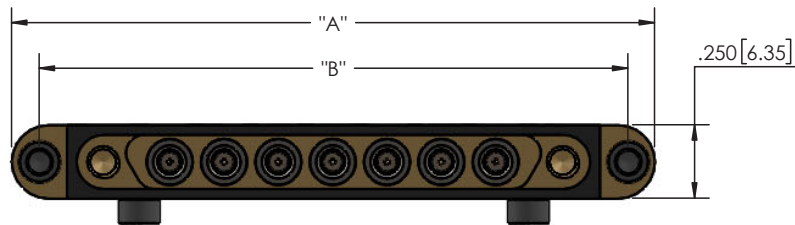
Part Number	Housing Configuration	PCB Mount	CC Termination	OC Termination
<b>8869000G91P-048</b>	Right Angle	Edge Launch	Surface Mount	Surface Mount
Product Features				
Housing Material	Brass	Interface Seal Material	Silicone Rubber	
Housing Plating	Gold	Port Identifiers	Laser Marked A-H	
Hardware Material	Steel	Distance Between Ports	.185"	
Hardware Plating	Passivated	Block Height & Width	.250"	



**Dimensions For 2 Port Thru 8 Port**

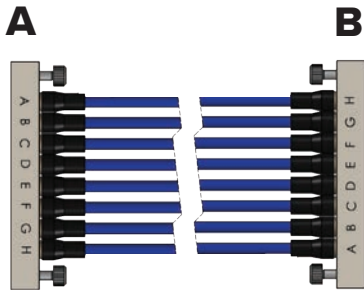
**Distance Between All Ports: .185" TYP Height & Width All Blocks .250" TYP**

Delta Part #	A	B	Ports	Delta Part #	A	B	Ports
Fig 2 - 8869000G91P-095	1.265	1.077	2	Fig 6 - 8869000G91P-099	2.005	1.817	6
Fig 3 - 8869000G91P-096	1.450	1.262	3	Fig 7 - 8869000G91P-0100	2.190	2.002	7
Fig 4 - 8869000G91P-097	1.635	1.447	4	Fig 8 - 8869000G91P-048	2.375	2.187	8
Fig 5 - 8869000G91P-098	1.820	1.632	5				

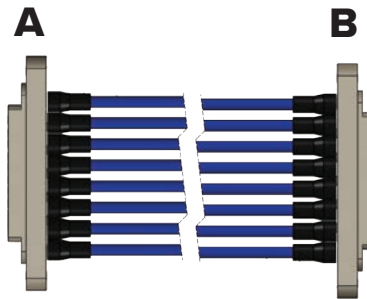




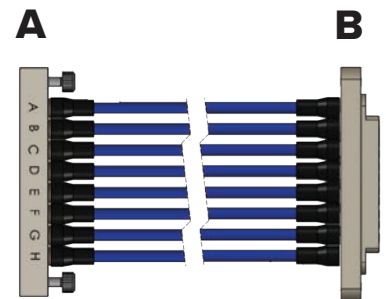
**Build Your Own SMPM-G Assembly**



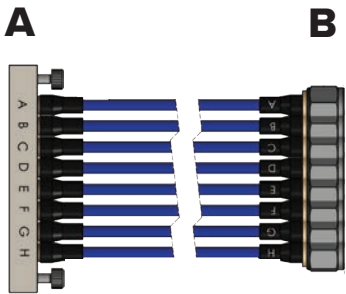
**Configuration 1**  
Female to Female



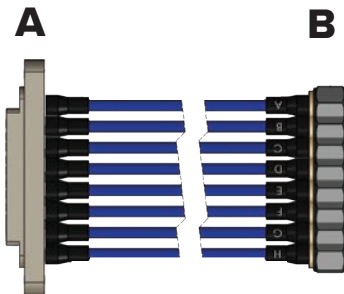
**Configuration 2**  
Male to Male



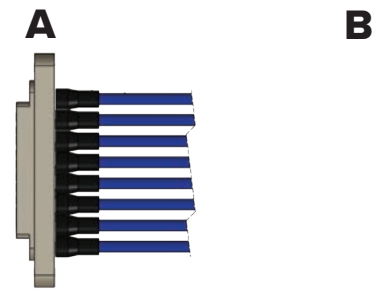
**Configuration 3**  
Female to Male



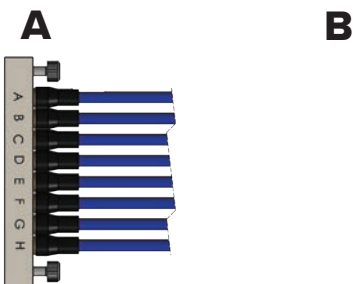
**Configuration 4**  
Female to Discrete RF



**Configuration 5**  
Male to Discrete RF



**Configuration 6**  
Male to Blunt Cut



**Configuration 7**  
Female to Blunt Cut





# Build Your Own SMPM-G Cable Assembly

**Configuration #** \_\_\_\_\_ **# Ports Per Housing**  
**Housing A:** \_\_\_\_ **B:** \_\_\_\_

**Begin a Cable Gang Mount** **Choose Configuration On Left**

1. F - F	5. M - Discrete RF
2. M - M	6. M - Blunt Cut
3. F - M	7. F - Blunt Cut
4. F - Discrete RF	

**Choose From 2 to 8 Port Housing A & B:**

**Select Connector Options**

- C1 Straight Female
- C2 R/A Female
- C3 Straight Male
- C4 R/A Male
- C5 Other

**Select Connector Housing A:** \_\_\_\_ **Housing B:** \_\_\_\_

**Define length of assembly in inches, from the end of the straight connectors & from the centerline of R/A connectors**

**Choose Length of Cable**

**Selects Cable Type**

**Choose Cable Type**

- Flex SR
- Semi-Rigid

**Choose .047" .086"**

**Select Cable Diameter** \_\_\_\_\_

**Provide Target Return Loss or VSWR Max. Frequency**

**VSWR**

**Insertion Loss**

**Choose Frequency Requirements DC-65 GHz**

**Shrink Sleeves**

**Shrink Sleeve Markings**

**A Delta Finished Customized Gang Mount Cable Assembly**

**Provide Target Insertion Loss or VSWR Max. Frequency**

\_\_\_\_\_

**Provide Max. Operating Frequency**

\_\_\_\_\_

Labels & Identification Circle Your Choices		
Connector A Shrink Tubing	Yes - .500"	No Tubing
Add Marking:		
Connector B Shrink Tubing	Yes - .500"	No Tubing
Add Marking:		
Center Label, .750"	Yes - .750"	No Tubing
Add Marking:		



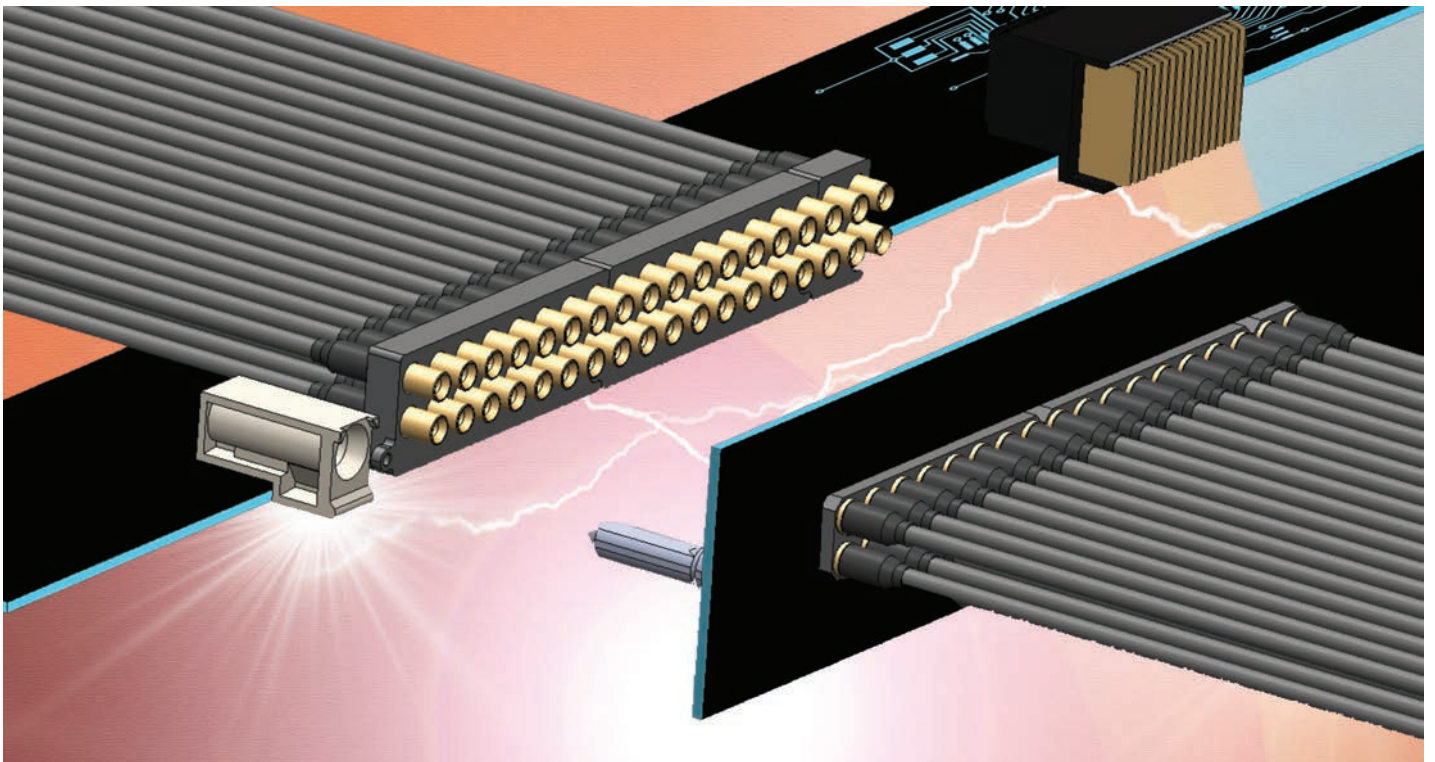
**SMP-G, SMPM-G and SMP3-G Cable Assemblies.**



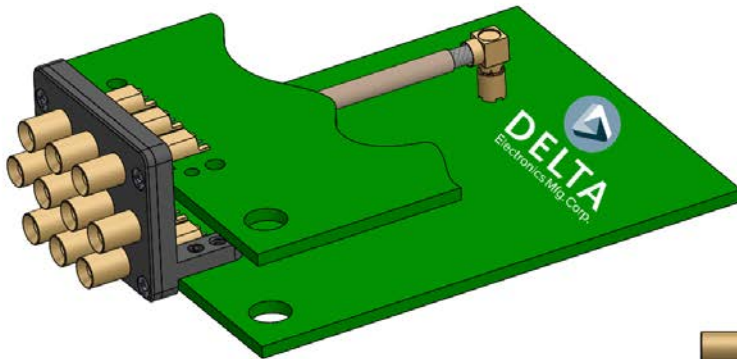
Delta offers custom RF cables with either .047" or .086" semi-rigid or the flexible equivalents. Lower loss cable options, with VoP's up to 83%, may also be available for specific configurations.

Insertion loss, return Loss, phase and delay measurements are available up to 65 GHz.

Delta's cable assembly technicians are trained to IPC-A-620 and J-STD-001 inspection and soldering.

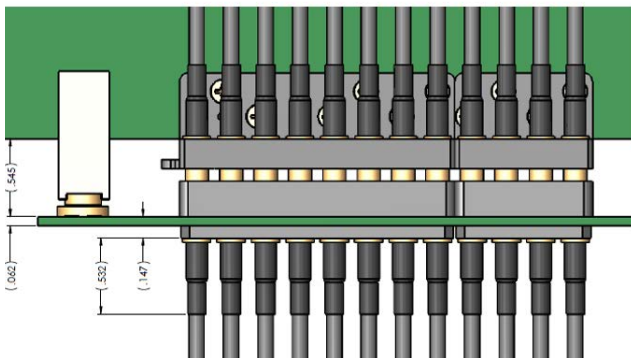
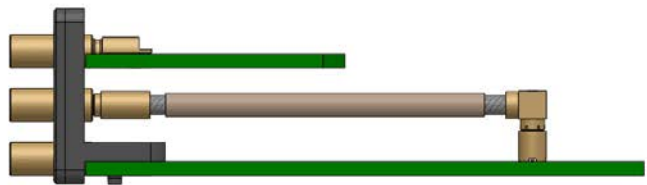


**SMP-G, SMPM-G and SMP3-G PCB Board Mounts**



VITA 67.3 offers a new design option where you now can launch directly from the Plug-In Connector Module directly to a PCB.

The concept shown includes an example of two PCB options: Direct to PCB using edge launch or cables.



In addition to SMPM-G, Delta provides ganged RF solutions using the SMP and SMP3 interfaces. Housings are standardized with 2, 3, 4, 5, 6, 7, and 8 port designs. Critical interface dimensions meet Mil-STD-348, DSCC 94007, 94008, IEC 61169-60 and IEC 61169-44 industry specifications as applicable.

Custom configurations can be designed for all ganged series including SMP-G, SMPM-G and SMP3-G with up to to four rows and SMP port counts up to 16, SMPM port counts up to 32 and SMP3 port counts up to 64. From a dimensional perspective, the center-to-center spacing of ports for an SMP-G is .240", the SMPM-G is .185" and the SMP3-G is .098".

Delta's hyper-responsive engineering team will customize mechanical layouts for varying board thicknesses, unique footprints, custom cable designs and extreme mechanical, electrical or environmental requirements.

Vita 67.1, 67.2 and 67.3 Housings and SMPM connector designs are also available with many configurations already stocked with Delta's franchised distributors.

**SMPM-G Cable Options**

**Cable Options**

Mechanical	.040"	.047"	.086"
Center Conductor	.008"	.011"	.020"
Dielectric	.026"	.036"	.064"
Braid	.040"	.047"	.085"
Outer Jacket	.060"	.059"	.104"
Static Bend Radius	5mm	5mm	6.35mm
Dynamic Bend Radius	10mm	10mm	12.7mm

Materials	.040"	.047"	.086"
Center Conductor	Silver Plated Copper	Silver Plated Copper	Silver Plated Copper
Dielectric	PTFE	PFA	PTFE
Inner Shield	Flat SPC	Flat SPC	Flat SPC
Outer Shield	Silver Plated Copper	Silver Plated Copper	Silver Plated Copper
Outer Jacket	FEP	FEP	FEP

Electrical	.040"	.047"	.086"
Operating Frequency	110 GHz	50 GHz	40 GHz
Impedance	50 Ω	50 Ω	50 Ω
VoP (%)	71.00%	70.00%	70.00%
Shielding Effectiveness	> 90 dB	> 90 dB	> 90 dB
Attenuation dB/ft			
1.0 GHz	0.60	0.35	0.21
2.0 GHz	0.86	0.53	0.31
8.0 GHz	1.74	1.15	0.66
12 GHz	2.14	1.44	0.83
18 GHz	2.64	1.85	1.06
26 GHz	3.18	2.22	1.34
40 GHz	3.96	2.83	1.73
50 GHz	4.44	3.20	
60 GHz	4.88		

*\*All specifications for reference only*

Environmental			
Operating Temp Range	-65° C to + 150° C	-65° C to + 150° C	-55° C to + 125° C

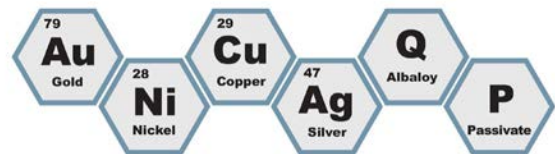


## Delta Vertical Integration In-house Automated Precious Metal Plating

Connectors are only as good as their plating, and that's why we decided this important process needed to be on-site. Having our own plating line, yields high quality, low costs, and reduced lead times. Call Delta for your electroplating needs. We also encourage current and potential customers to tour our facility.



### Delta Plating Finishes:



### Automated Tin/Lead Dipping For SMP-T, SMPM-T & SMP3-T

Our customized automated tin / lead dipping equipment enables high volume processing of our SMP-T, SMPM-T and SMP3-T PCB mount configurations. The finished connector is of high quality, with a consistent tin/lead flowed finish. Experience the Delta Difference!

**Spring Loaded Bullets**

**Feature:**

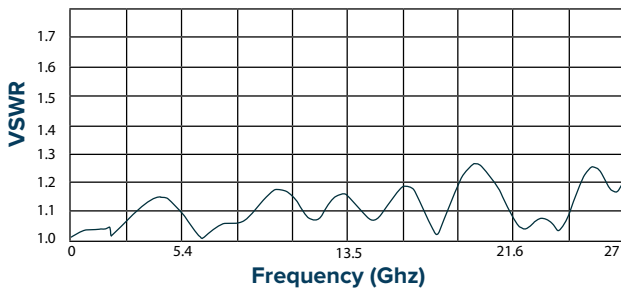
- Increased axial & radial float
- One side has as a low insertion SMP interface
- High compression load on interfaces

**Benefit:**

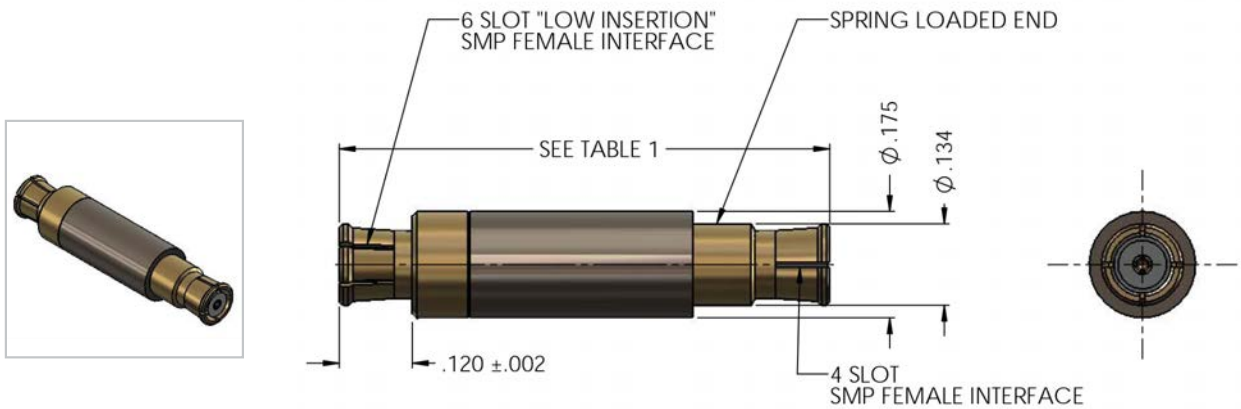
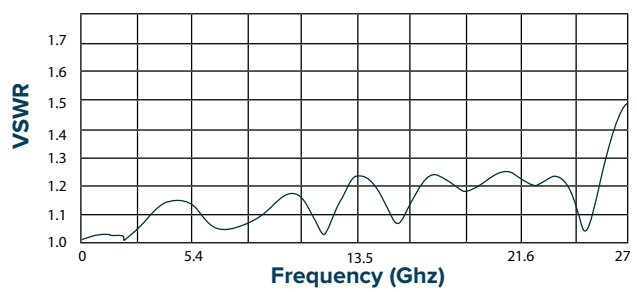
- Enhanced self alignment during mating
- Consistently un-mate from the same end
- Improved VSWR at higher frequencies

**VSWR**

**Uncompressed**



**Compressed**



**VSWR:** 1.5:1 Max

**Frequency Range:** DC - 26.5 GHz

**Float:** Axial .075 / Radial .015

Delta P/N	Uncompressed Length	Fully Compressed Length
8628000G911-005	1.075	1.000
8628000G911-004	.675	.600

Please contact the factory for additional lengths.

**8628000G911 - XXX**

Spring Loaded Female to Female "Bullet" Adapter

**SMP / SMPM / SMP3 Bullets**

**Delta's Bullet Adapters**

Ideal for board-to-board mechanical schemes, Delta's Bullet Adapters make the connections and accommodate varying board-to-board stack heights.

Available in fixed lengths and spring loaded configurations.

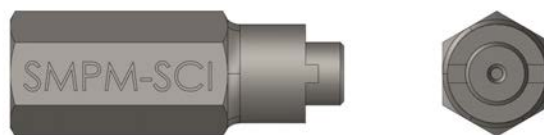
Call Delta today to find the perfect fit! 978-927-1060 or email [sales@deltarf.com](mailto:sales@deltarf.com)



**SMPM-G Tooling**



BASE TOOL



**T33-88001-01**

**T38-88006-01**



EXTRACTION HEAD



INSERTION HEAD





**DELTA**  
Electronics Mfg. Corp.

# BLIND MATE RF GANG MOUNTS



[sales@deltarf.com](mailto:sales@deltarf.com) (978) 927-1060 [deltarf.com](http://deltarf.com)

**416 Cabot Street, Beverly, MA 01915**