

General Description

Delta SMB connectors are subminiature, 50 Ω impedance connectors with snap-on coupling. They are best suited for use with cables in the range of .070" to .120" diameter, such as RG-178 and RG-316/U.

Delta SMC connectors (page 4) are similar in size and construction to SMB series, but employ #10–32 threaded coupling, and have a higher upper frequency limit than SMB.

All Delta SMB and SMC connectors are available with gold-plated bodies, or with nickel-plated bodies for economy.

Adapters between SMB and other series can be found in the Between Series Catalog.

As with our other connector series, Delta's customer-driven design results in SMB and SMC series connectors with practical and unique features that make your design and assembly process easier. Some of these include:

- SMB PressMount receptacles (page 3) mount securely in a single round hole, saving space on your components and reducing your housing fabrication costs.
- SMB and SMC panel receptacles with flange sizes to match the same hole pattern as standard SMA connectors, letting you drill one hole pattern and mount SMB, SMC, BNC, N, SMA, or TNC series connectors as needed.

Our SMB and SMC series product line is still growing, so please call if you don't see what you need.

SMB Configurations

Straight Cable Plugs	1
Right Angle Cable Plugs.....	1
Bulkhead Cable Jacks	1
Bulkhead Jack Receptacles.....	2
Panel Jack Receptacles (square flange)	2
PressMount receptacles	3
Printed-Circuit Board Receptacles	3

SMC Configurations

Straight Cable Plugs	4
Right Angle Cable Plugs.....	4
Bulkhead Cable Jacks	4
Bulkhead Jack Receptacles.....	5
Panel Jack Receptacles (square flange)	5
Printed-Circuit Board Receptacles	5

SMB & SMC Specifications*

SMB Interfaces**

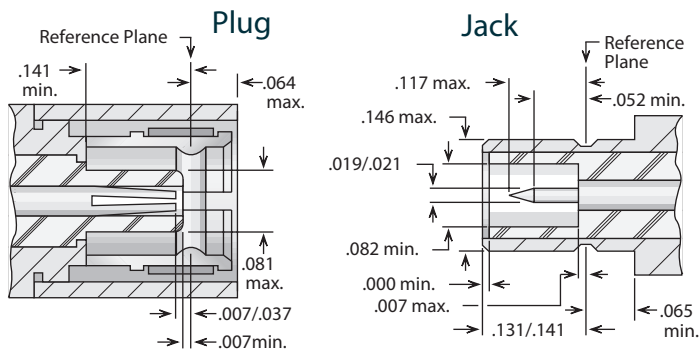

Electrical:

Nominal Impedance: 50 ohms.

Frequency Range: SMB: DC–4 GHz.

SMC: DC–10 GHz.

Voltage Rating: 250 volts RMS (when used with RG-178-class cables); 335 volts RMS (when used with RG-316-class cables).

Dielectric Withstanding

Voltage : 750 volts RMS (when used with RG-178-class cables); 1,000 volts RMS (when used with RG-316-class cables).

Insulation Resistance: 1,000 megohms.

Materials/Finishes:

Insulators: Teflon per ASTM D1710.

Male Contacts: Brass per ASTM B16.

Female Contacts: Beryllium Copper per ASTM B196.

Contact Plating : Gold per MIL-DTL-45204.

Gaskets: Silicone rubber per ZZ-R-765, Class II, Grade 50.

Other Metal Parts: Brass per ASTM B16, plated:
 Gold per MIL-DTL-45208, or
 Nickel per AMS-QQ-N-290.

SMC Interfaces**

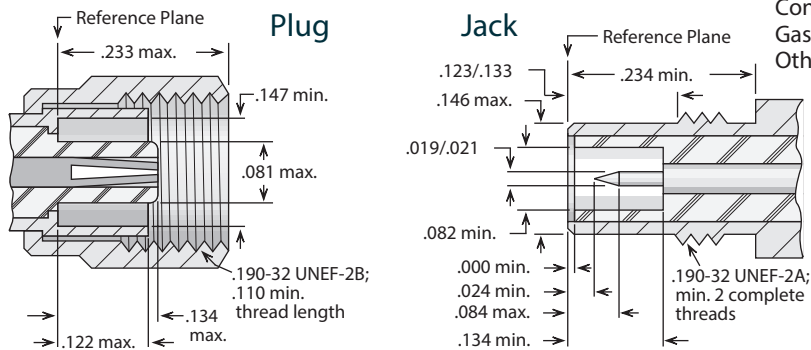

All other specifications are in accordance with the latest issues of MIL-PRF-39012, or MIL-A-55339, or other applicable MIL specifications, and interfaces are in accordance with MIL-STD-348.

*These specifications are typical and may not apply to all connectors. Detailed specifications for individual connectors are available on request.

**Some proportions altered to illustrate detail.

Straight & Right Angle Plugs - For Flexible Cable

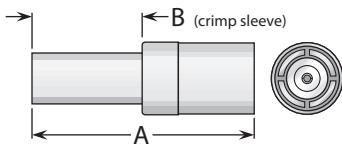

Figure 1
(Crimp type)

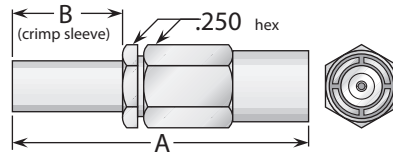

Figure 2
(Crimp type)

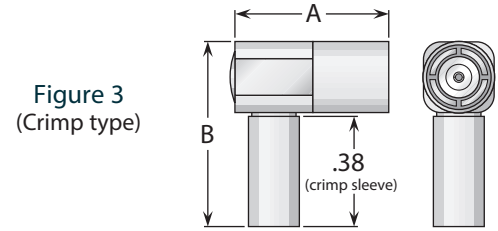

Figure 3
(Crimp type)

Cable Group	Figure	Dimensions		Plating		Delta P/N	Assembly Procedure/ Trim Code
		A	B	Body	Contact		
9	1	.800	.380	Gold	Gold	2403037G000-002	B/28
9	1	.800	.380	Nickel	Gold	2403037N000-002	B/28
9	2	1.03	.380	Gold	Gold (C)	2402037G001-000	***
9	2	1.03	.380	Nickel	Gold (C)	2402037N001-000	***
9	3	.520	.630	Gold	Gold (C)	2407037G001-000	B/29
9	3	.520	.630	Nickel	Gold (C)	2407037N001-000	B/29
10	1	.800	.380	Gold	Gold	2403100G000-000	B/28
10	1	.800	.380	Nickel	Gold	2403100N000-000	B/28
10	2	1.03	.380	Gold	Gold (C)	2402100G001-000	***
10	2	1.03	.380	Nickel	Gold (C)	2402100N001-000	***
10	3	.520	.630	Gold	Gold (C)	2407100G001-000	B/29
10	3	.520	.630	Nickel	Gold (C)	2407100N001-000	B/29
11	1	.800	.380	Gold	Gold	2403038G000-001	***
11	1	.800	.380	Nickel	Gold	2403038N000-001	***
11	2	1.03	.380	Gold	Gold (C)	2402038G001-000	***
11	2	1.03	.380	Nickel	Gold (C)	2402038N001-000	***
11	3	.520	.630	Gold	Gold (C)	2407038G001-001	B/29
11	3	.520	.630	Nickel	Gold (C)	2407038N001-001	B/29

Bulkhead Jack - For Flexible Cable

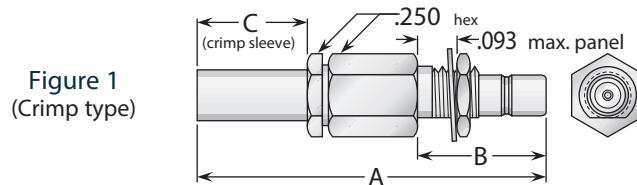

Figure 1
(Crimp type)

Cable Group	Fig.	Dimensions			Mounting Figure	Plating		Delta P/N	Assembly Procedure/ Trim Code
		A	B	C		Body	Contact		
9	1	1.17	.426	.380	68	Gold	Gold (C)	2419037G681-000	***
9	1	1.17	.426	.380	68	Nickel	Gold (C)	2419037N681-000	***
10	1	1.17	.426	.380	68	Gold	Gold (C)	2419100G681-000	***
10	1	1.17	.426	.380	68	Nickel	Gold (C)	2419100N681-000	***
11	1	1.17	.426	.380	68	Gold	Gold (C)	2419038G681-000	***
11	1	1.17	.426	.380	68	Nickel	Gold (C)	2419038N681-000	***

• See page 209 for cable groups. • Assembly procedures start on page 210. • ***Contact factory for cable assembly instructions.
• See page 208 for mounting dimensions. • (C) in contact plating column indicates captive contact.

Bulkhead Jack Receptacles

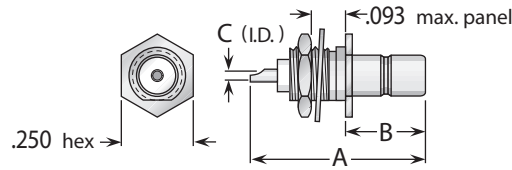

Figure 1

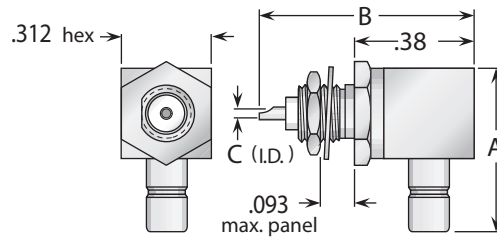

Figure 2

Figure	Dimensions			Mounting Figure	Plating		Delta P/N
	A	B	C		Body	Contact	
1	.590	.265	.035	68	Gold	Gold (C)	2420000G681-000
1	.590	.265	.035	68	Nickel	Gold (C)	2420000N681-000
2	.590	.750	.022	68	Gold	Gold (C)	2422000G681-000
2	.590	.750	.022	68	Nickel	Gold (C)	2422000N681-000

Panel Jack Receptacles

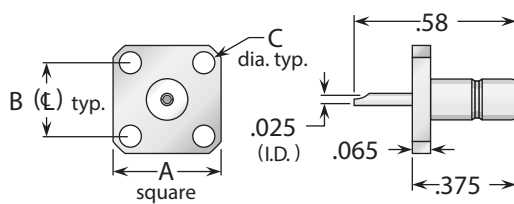

Figure 1
(3/8" square flange)

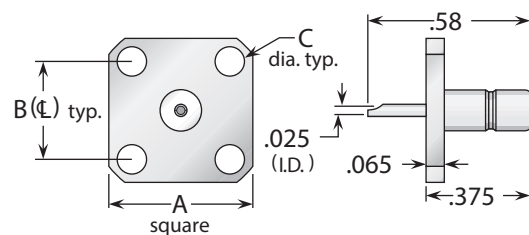

Figure 2
(1/2" square flange)

Figure	Dimensions			Mounting Figure	Plating		Delta P/N
	A	B	C		Body	Contact	
1	.375	.232	.093	91A	Gold	Gold (C)	2413000G911-000
1	.375	.232	.093	91A	Nickel	Gold (C)	2413000N911-000
2	.500	.340	.102	05	Gold	Gold (C)	2413000G051-000
2	.500	.340	.102	05	Nickel	Gold (C)	2413000N051-000

• See page 208 for mounting dimensions. • (C) in contact plating column indicates captive contact.

Printed-Circuit Board Receptacles

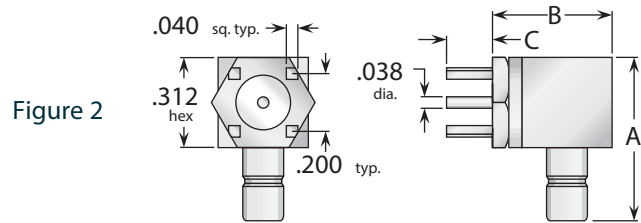
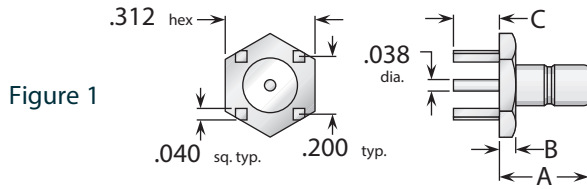
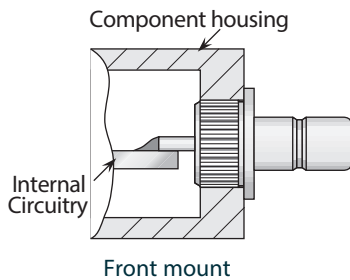

Figure	Dimensions			Max. Board	Mounting Figure	Plating		Delta P/N
	A	B	C			Body	Contact	
1	.300	.060	.155	.100	PCB06	Gold	Gold (C)	2468000G001-000
1	.300	.060	.155	.100	PCB06	Nickel	Gold (C)	2468000N001-000
2	.590	.375	.155	.100	PCB06	Gold	Gold (C)	2470000G00E-000
2	.590	.375	.155	.100	PCB06	Nickel	Gold (C)	2470000N00E-000

Press Mount Receptacles

Delta PressMount Receptacles



These connectors eliminate the need for complicated mounting hole patterns and mounting hardware. They are simply pressed into a single through hole, and the precisely-engineered knurled mounting section provides retention strength far greater than normal mating and unmating forces. An integral shoulder provides a positive stop when mounting.

PressMounts are available for a wide variety of Delta connector series, and can be used in packages as small as the outer diameter of the connector body.

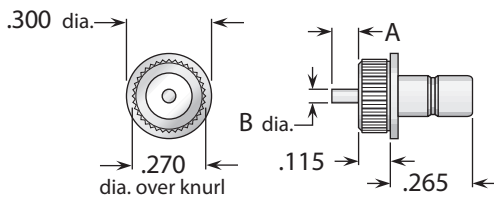
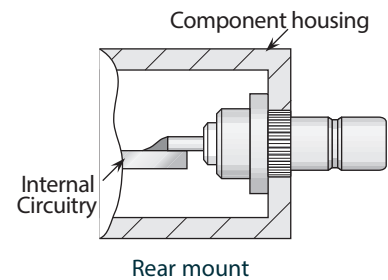

Figure 1
(Post contact, front mount, stainless steel body)

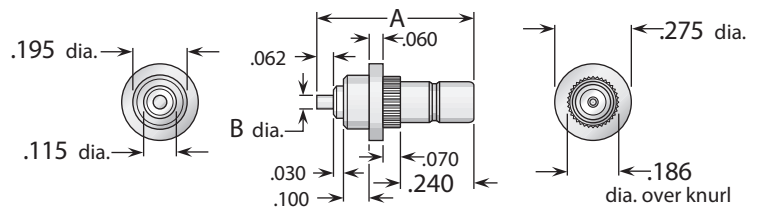

Figure 2
(Post contact, rear mount, brass body)

Figure	Dimensions		Min. Panel	Mounting Hole	Plating		Delta P/N
	A	B			Body	Contact	
1	.062	.050	.100	.267 ±.001 dia.	Passivated	Gold (C)	2420000K911-001
2	.500	.060	.062	.182 ±.001 dia.	Gold	Gold (C)	2421000G911-000

• See page 208 for mounting dimensions. • (C) in contact plating column indicates captive contact.

Straight & Right Angle Plugs - For Flexible Cable

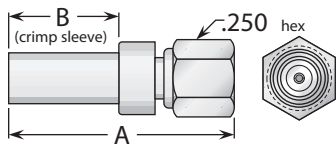

Figure 1
(Crimp type)

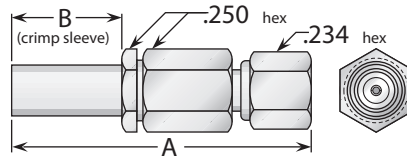

Figure 2
(Crimp type)

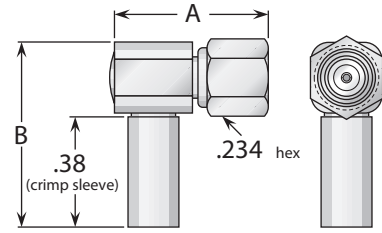

Figure 3
(Crimp type)

Cable Group	Figure	Dimensions		Plating		Delta P/N	Assembly Procedure/ Trim Code
		A	B	Body	Contact		
9	1	.800	.380	Gold	Gold	2503037G000-000	B/28
9	1	.800	.380	Nickel	Gold	2503037N000-000	B/28
9	2	1.03	.380	Gold	Gold (C)	2502045G001-001	***
9	2	1.03	.380	Nickel	Gold (C)	2502045N001-001	***
9	3	.560	.630	Gold	Gold (C)	2507037G001-000	B/29
9	3	.560	.630	Nickel	Gold (C)	2507037N001-000	B/29
10	1	.800	.380	Gold	Gold	2503100G000-000	B/28
10	1	.800	.380	Nickel	Gold	2503100N000-000	B/28
10	2	1.03	.380	Gold	Gold (C)	2502100G000-001	***
10	2	1.03	.380	Nickel	Gold (C)	2502100N000-001	***
10	3	.560	.630	Gold	Gold (C)	2507100G001-000	B/29
10	3	.560	.630	Nickel	Gold (C)	2507100N001-000	B/29
11	1	.800	.380	Gold	Gold	2503038G000-000	B/28
11	1	.800	.380	Nickel	Gold	2503038N000-000	B/28
11	2	1.03	.380	Gold	Gold (C)	2502038G001-001	***
11	2	1.03	.380	Nickel	Gold (C)	2502038N001-001	***
11	3	.560	.630	Gold	Gold (C)	2507038G001-000	B/29
11	3	.560	.630	Nickel	Gold (C)	2507038N001-000	B/29

Bulkhead Jack - For Flexible Cable

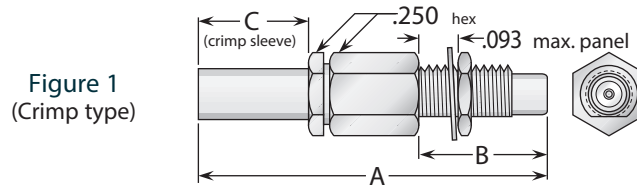

Figure 1
(Crimp type)

Cable Group	Fig.	Dimensions			Mounting Figure	Plating		Delta P/N	Assembly Procedure/ Trim Code
		A	B	C		Body	Contact		
9	1	1.17	.426	.380	68	Gold	Gold (C)	2519037G681-000	***
9	1	1.17	.426	.380	68	Nickel	Gold (C)	2519037N681-000	***
10	1	1.17	.426	.380	68	Gold	Gold (C)	2519100G681-000	***
10	1	1.17	.426	.380	68	Nickel	Gold (C)	2519100N681-000	***
11	1	1.17	.426	.380	68	Gold	Gold (C)	2519038G681-000	***
11	1	1.17	.426	.380	68	Nickel	Gold (C)	2519038N681-000	***

- See page 209 for cable groups.
- Assembly procedures start on page 210.
- ***Contact factory for cable assembly instructions.
- See page 208 for mounting dimensions.
- (C) in contact plating column indicates captive contact.

Bulkhead Jack Receptacles

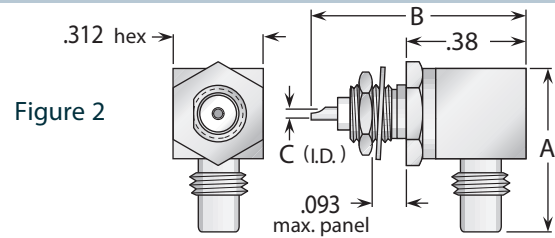
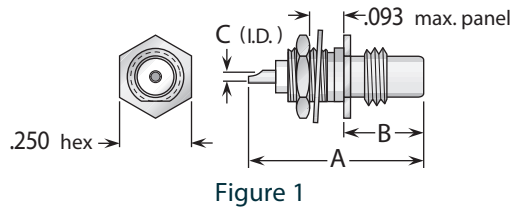

Figure	Dimensions			Mounting Figure	Plating		Delta P/N
	A	B	C		Body	Contact	
1	.590	.265	.035	68	Gold	Gold (C)	2520000G681-000
1	.590	.265	.035	68	Nickel	Gold (C)	2520000N681-000
2	.590	.750	.022	68	Gold	Gold (C)	2522000G681-000
2	.590	.750	.022	68	Nickel	Gold (C)	2522000N681-000

Panel Jack Receptacles

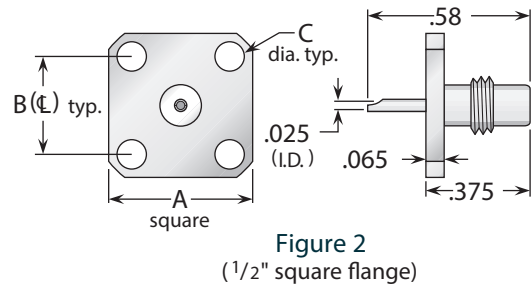
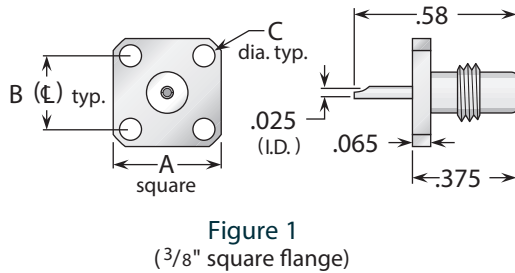

Figure	Dimensions			Mounting Figure	Plating		Delta P/N
	A	B	C		Body	Contact	
1	.375	.232	.093	91A	Gold	Gold (C)	2513000G911-000
1	.375	.232	.093	91A	Nickel	Gold (C)	2513000N911-000
2	.500	.340	.102	05	Gold	Gold (C)	2513000G051-000
2	.500	.340	.102	05	Nickel	Gold (C)	2513000N051-000

Printed-Circuit Board Receptacles

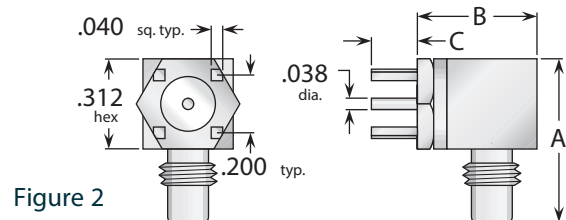
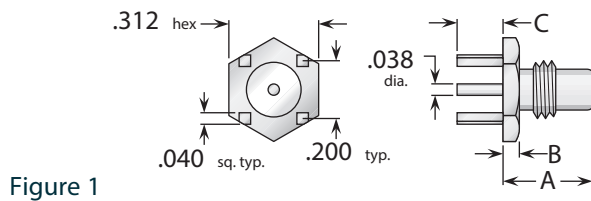

Figure	Dimensions			Max. Board	Mounting Figure	Plating		Delta P/N
	A	B	C			Body	Contact	
1	.300	.060	.155	.100	PCB06	Gold	Gold (C)	2568000G001-000
1	.300	.060	.155	.100	PCB06	Nickel	Gold (C)	2568000N001-000
2	.590	.375	.155	.100	PCB06	Gold	Gold (C)	2570000G00E-000
2	.590	.375	.155	.100	PCB06	Nickel	Gold (C)	2570000N00E-000

See page 208 for mounting dimensions. • (C) in contact plating column indicates captive contact.