

1396-000-K911-030

DIMENSIONS IN BRACKETS ARE IN MILLIMETERS AND ARE FOR REFERENCE ONLY.

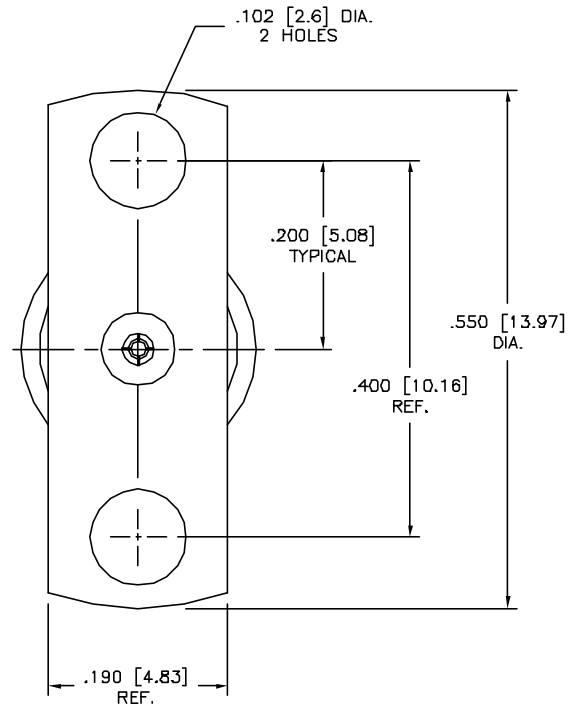
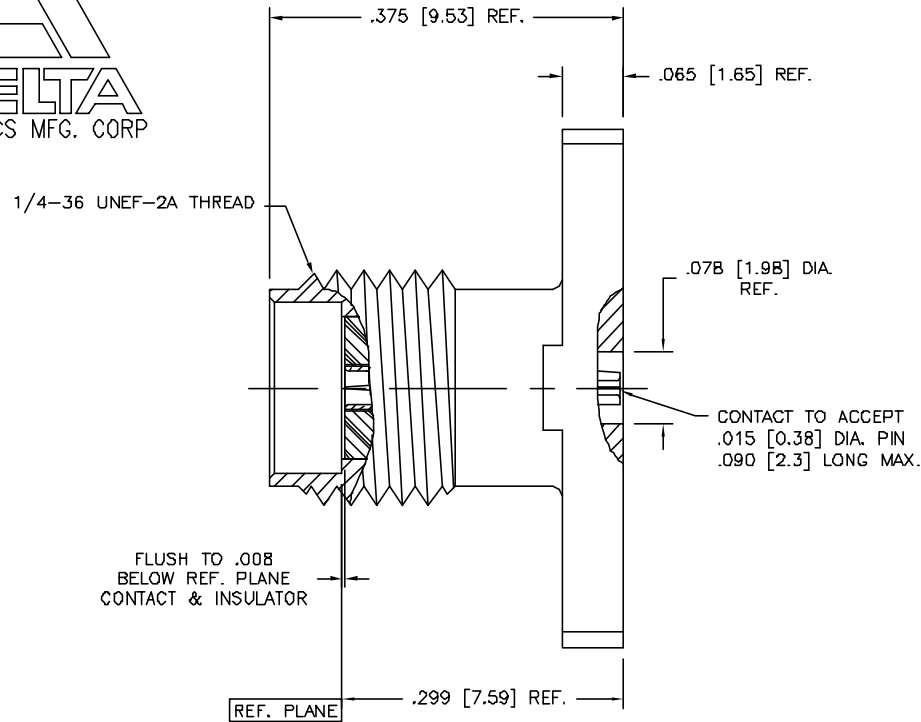

NOTES:

- CONNECTOR INTERFACE IS DESIGNED IN ACCORDANCE WITH MIL-STD-348, EXCEPT AS NOTED.
- MATERIAL: BODY - CORROSION RESISTANT STEEL PER ASTM A582, TYPE 303
CONTACT - BERYLLIUM COPPER, ALLOY C17300 PER ASTM B196.
INSULATOR - TEFLON (PTFE), PER ASTM D1710
- FINISHES: BODY - PASSIVATE PER AMS-QQ-P-35
CONTACT - GOLD PLATE PER MIL-G-45204
- ELECTRICAL DATA:
IMPEDANCE: 50 OHMS NOMINAL
FREQUENCY: DC TO 26.5 GHz

ELECTRICAL DATA (CONT.):

VSWR: DC TO 18.0 GHz - 1.15:1 MAXIMUM
18.0 TO 26.5 GHz - 1.25:1 MAXIMUM
INSERTION LOSS: $.03 \sqrt{f(\text{GHz})}$ dB MAXIMUM
INSULATION RESISTANCE: 5,000 MEGOHMS MINIMUM
VOLTAGE RATING: 1,000 Vrms MINIMUM AT SEA LEVEL,
250 Vrms MINIMUM AT 70,000 FEET
DIELECTRIC WITHSTANDING VOLTAGE: 1,000 Vrms MINIMUM
RF LEAKAGE: -100 dB MIN.

DELTA ELECTRONICS MFG. CORP. Beverly, MA 01915				
TITLE: 'SMA' PANEL MOUNT JACK RECEPTACLE, 2 HOLE FLANGE FIELD REPLACEABLE, AIRSECTION - ACCEPTS .015 D. PIN				
MATERIAL: SEE NOTE 2				
FINISH: SEE NOTE 3				
BUM STM 8/17/04	Scale 8/1	Dkd. by	Mfg. Appd.	Engr. Appd.
CODE IDENT.-00795		1396-000-K911-030		

UNLESS OTHERWISE SPECIFIED; TOLERANCES: 3 PLACES = ±.005, 2 PLACES = ±.02, ANGLES = ±1/2°. SURFACE FINISH = 63

-	OUTLINE	11/16/06
ALT.	REVISIONS	DATE

-	REL	ERN	x				
ALT.	REVISIONS	DATE	ENGR APPD	MFG APPD			

FILE NAME: 1396000K911-030T PLT 8/1

THESE DRAWINGS AND SPECIFICATIONS ARE THE PROPERTY OF DELTA ELECTRONICS MFG CORP. AND SHALL NOT BE REPRODUCED, OR COPIED OR USED AS THE BASIS FOR THE MANUFACTURE OR SALE OF APPARATUS OR DEVICES WITHOUT THEIR EXPRESS WRITTEN CONSENT.