

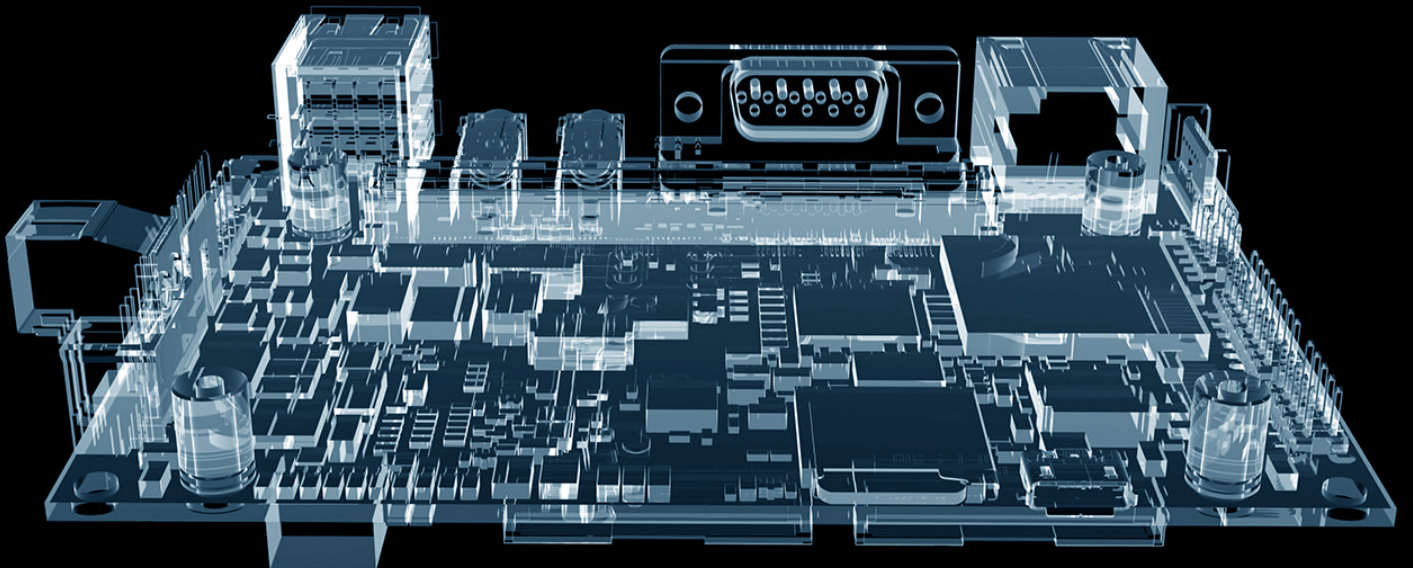

SMA Extended Frequency

26.5 - GHz

27.0 - GHz



Extended-Frequency SMA Connectors

This brochure introduces two new series of connectors that extend SMA performance beyond the MIL-PRF-39012 upper frequency limit of 18 GHz, while maintaining MIL-STD-348 mating characteristics for backward compatibility with standard SMA connectors when required.

With both 26.5-GHz precision types and 27.0-GHz high-performance types available, you can choose the best price / performance balance for your application, with no need to “overspecify.” This brochure features configurations to fulfill most standard applications, but any item shown can be customized for your specific needs.

SMA 26.5-GHz Connectors (Page 2)

These extended-frequency, precision SMA series connectors feature maximum VSWR of 1.15:1 from DC to 18 GHz, and 1.25:1 from 18 to 26.5 GHz.

Along with cable connectors for semi-rigid cable, our SMA 26.5-GHz line includes receptacles with post contacts and integral metal contact rings, and field-replaceable types in a variety of flange sizes. These field-replaceable receptacles are available as jacks or plugs, each with a choice of air or PTFE rear dielectric matching sections, and with or without EMI gaskets.

The field-replaceable receptacles are available for use with hermetic seals or accessory pins with diameters of .012, .015, .018, .020, or .036 inches. Standard hermetic seals are also shown in this brochure, and can be modified to a wide range of configurations to match your application requirements.

Three types of SMA 26.5-GHz adapters are also included in this series, as are bulkhead receptacles.

Performance Features:

- Mode free through 26.5 GHz
- Low reflection loss (VSWR)
- Low Insertion Loss
- Low RF Leakage > -100 dB
- Consistent Unit to Unit Performance
- All materials meet the Outgassing Requirements of NASA Publication 1124

SMA 27.0-GHz Connectors (Page 16)

These high-performance SMA connectors feature maximum VSWR of 1.10:1 from DC to 18 GHz, and 1.15:1 from 18 to 27.0 GHz.

They are designed to provide enhanced durability and reliability in a “field grade” production connector.

The internal design is optimized using state-of-the-art Electromagnetic Finite Element Analysis model simulation to provide low reflection coefficient, with mode free operation to 27.0 GHz.

In addition, this connector series provides -100 dB RF leakage due to the precision finish on the interface and mounting surfaces to assure a solid 360-degree contact in the critical RF return path, and the absence of epoxy holes in the connector body. The design of the internal structure provides a reliable and symmetrical axial captivation by mechanical means with a minimal disturbance to the transmission line characteristics and has a maximum continuous service temperature of 165° C.

SMA 27.0 GHz field replaceable connectors are available in six common mounting flange configurations. Both the field replaceable and thread-in (spark plug) connectors are available for use with hermetic seals or accessory pins with diameters of .009, .012, .015, .018, .020, and .036 inches. Standard hermetic seals are also shown in this brochure, and can be modified to a wide range of configurations to match your application requirements.

These connectors are machined to exacting tolerances and the highest quality standards on modern CNC turning centers, and assembly is tightly controlled and monitored to ensure peak consistency of performance from unit to unit.

Performance Features:

- Mode free through 27.0 GHz
- Low reflection loss (VSWR)
- Low Insertion Loss
- Low RF Leakage > -100 dB
- Extended Operating Temperature (+165° C)
- Phase Stable
- Consistent Unit to Unit Performance
- Rigid center contact captivation using high temperature Ultem 1000 support bead
- All materials meet the Outgassing Requirements of NASA Publication 1124

General Description

These extended-frequency, precision SMA connectors feature maximum VSWR of 1.15:1 from DC to 18 GHz, and 1.25:1 from 18 to 26.5 GHz.

Along with cable connectors for semi-rigid cable, our SMA 26.5-GHz line includes receptacles with post contacts and integral metal contact rings, and field-replaceable types in a variety of flange sizes. These field-replaceable receptacles are available as jacks or plugs, each with a choice of air or PTFE rear dielectric matching sections, and with or without EMI gaskets.

The field-replaceable receptacles are available for use with hermetic seals or accessory pins with diameters of .012, .015, .018, .020, or .036 inches. Standard hermetic seals are also shown in this brochure, and can be modified to a wide range of configurations to match your application requirements.

Three types of SMA 26.5-GHz adapters are also included in this series, as are bulkhead receptacles.

We are continually expanding our SMA 26.5-GHz product line and other high-frequency products, so please call if you don't see what you need.

Contents

Interface Dimensions and Specifications	4	Bulkhead Jack Receptacles	15
Cable Connectors	5	Adapters Within Series	15
Panel Receptacles—Post Contact	6	Accessory Pins	15
Field Replaceable Panel Jack Receptacles—		Hermetic Seals	16
Air Dielectric, No EMI Gasket	7	Drilling Dimensions—	
Air Dielectric, With EMI Gasket	8	Hermetic Seals	16
PTFE Dielectric, No EMI Gasket	9	Replacement EMI Gaskets	16
PTFE Dielectric, With EMI Gasket	10	Drilling Dimensions—	
Field Replaceable Panel Plug Receptacles—		Panel-Mount Receptacles	27
Air Dielectric, No EMI Gasket	11	Competitive Cross-Reference	28
Air Dielectric, With EMI Gasket	12	Index by Part Number	32
PTFE Dielectric, No EMI Gasket	13	About Delta	34
PTFE Dielectric, With EMI Gasket	14		

Test Data

Test Setup

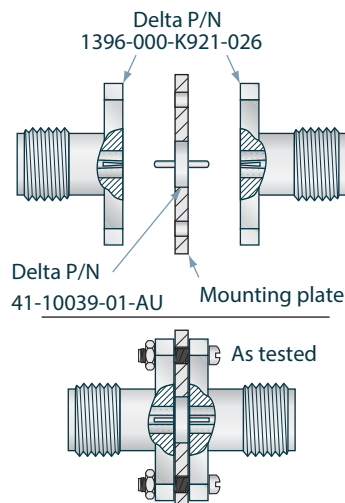

VSWR

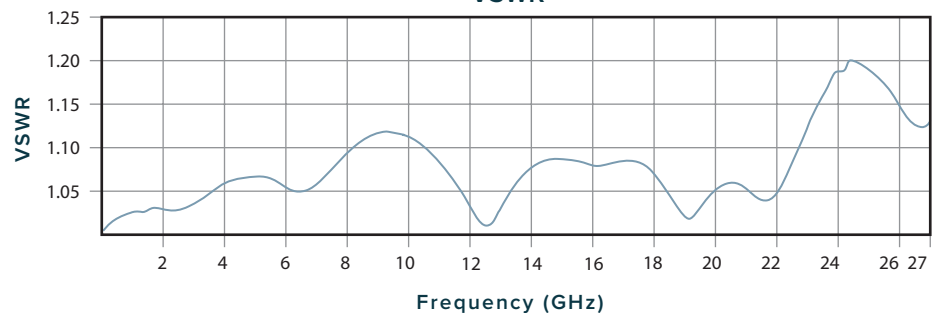

Two connectors tested, mounted back-to-back with a hermetic seal as shown at left. Maximum VSWR 1.20:1 @ 24.36 GHz (1.095:1 for each connector.)

These results are typical and valid only for connectors set up for testing in the configuration shown. Hermetic seal attachment method and other circuitry characteristics will affect VSWR of the completed component.

See next page for interface dimensions and specifications.

SMA 26.5 GHz Interfaces

Plug Interface **

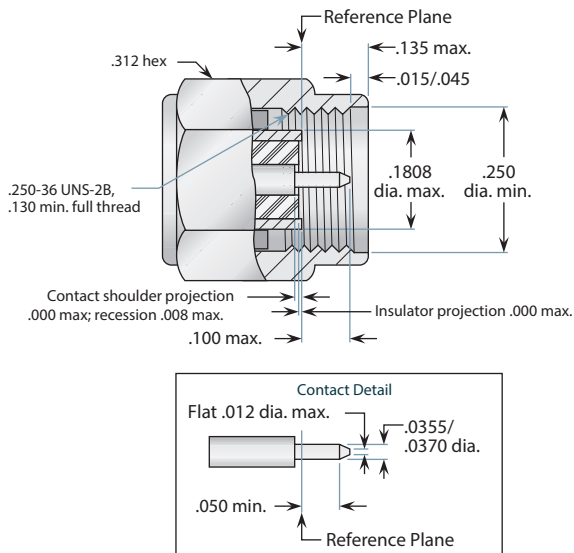

Jack Interface **

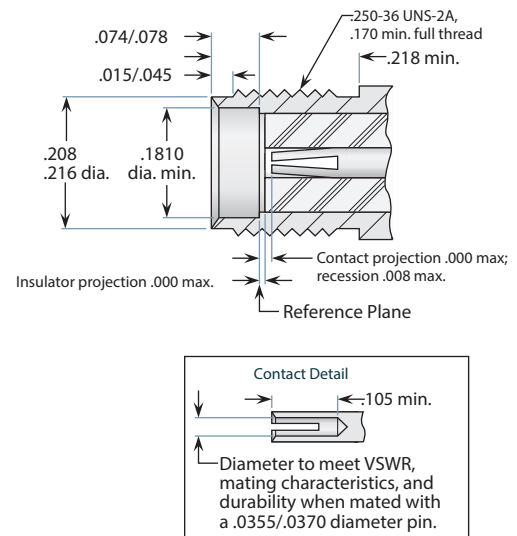

** Per MIL-STD-348, figures 310-1 and 310-2. Some proportions altered to illustrate detail.

SMA 26.5 GHz Specifications *

Electrical:

Nominal Impedance: 50 ohms.

Frequency Range: DC–26.5 GHz.

Voltage Rating: 335 Volts RMS (@ sea level).

VSWR: DC–18 GHz: 1.15:1 maximum;

18–26.5 GHz: 1.25:1 maximum.

RF Transmission Loss: $.03 \times \sqrt{f}$ (GHz) dB.

Dielectric Withstanding Voltage: 1000 Volts RMS (@ sea level).

RF Hipot: 670 Volts RMS @5 MHz.

Insulation Resistance: 10,000 megohms.

RF Leakage: -100 dB minimum @3 GHz.

Contact Resistance: Center contact: 3.0 milliohms maximum;
Outer contact: 2.0 milliohms maximum.

Mechanical:

Force to Engage: 2 inch-pounds maximum.

Coupling Nut Retention: 60 pounds minimum (plugs only).

Coupling Proof Torque: 15 inch-pounds minimum (plugs only).

Contact Insertion Force: Insertion: 2 pounds maximum;
withdrawal: 1 ounce minimum.

Durability: 500 mating cycles minimum.

Mating Torque: 7–10 inch-pounds.

Materials/Finishes:

Insulators: Teflon PTFE per ASTM D1710.

Contacts: Beryllium Copper (Alloy C17300) per ASTM B196.

Contact Plating: Gold per MIL-G-45204.

Other Metal Parts: Type 303 Stainless steel per ASTM A582, plated gold per MIL-G-45204 or passivated per AMS-QQ-P-35.

Gaskets: Silicone rubber per A-A-59588.

EMI Gaskets: Conductive elastomer per MIL-G-83528, type F.

Environmental:

Operating Temperature: -65 to +125° C.

Vibration: Per MIL-STD-202, Method 204, test condition D.

Shock: Per MIL-STD-202, Method 213, test condition I.

Thermal Shock: Per MIL-STD-202, Method 107, test condition A.

Corrosion (Salt Atmosphere): Per MIL-STD-202, Method 101, test condition B.

Moisture Resistance: Per MIL-STD-202, Method 106, no measurements at high humidity. Insulation resistance 200 megohms minimum with 5 minutes of removal from humidity.

All materials meet outgassing requirements of NASA Publication 1124.

All other specifications are in accordance with the latest issues of MIL-PRF-39012, or MIL-PRF-55339, or other applicable MIL specifications, and interfaces are in accordance with MIL-STD-348.

*These specifications are typical and may not apply to all connectors. Detailed specifications for individual connectors are available on request.

Cable Connectors - Direct Solder For Semi-Rigid Cable

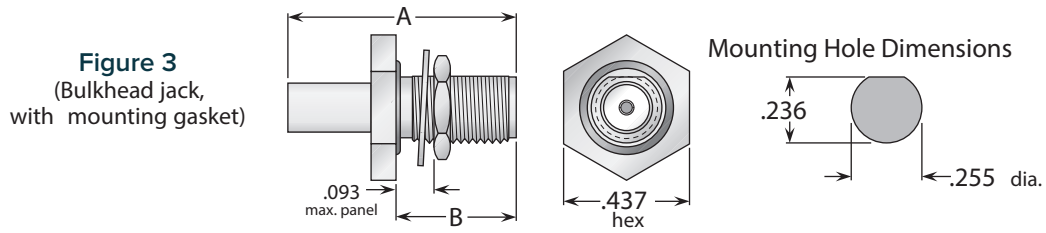
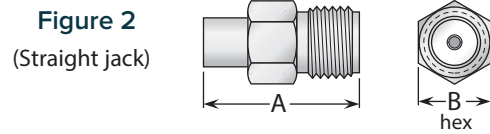
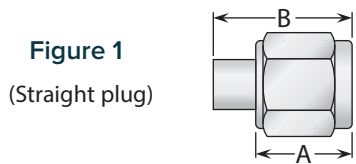

Cable Group	Figure	Dimensions		Plating		Delta P/N	Assembly Procedure/ Trim Code
		A	B	Body	Contact		
13	1	.330	.440	Gold/PCN ⁽¹⁾	Gold	1301031K003-900	H/01
13	2	.500	.250	Gold	Gold	1308031G003-900	H/01
13	3	.625	.415	Gold	Gold	1317031G673-900	H/01
14	1	.330	.440	Gold/PCN ⁽¹⁾	Gold	1301025K003-900	H/01
14	2	.500	.250	Gold	Gold	1308025G003-900	H/01
14	3	.625	.415	Gold	Gold	1317025G673-900	H/01

⁽¹⁾ Gold-plated body and passivated coupling nut.

Cable Groups

13: .141" semi-rigid; RG-402; M17/130

14: .085" semi-rigid; RG-405; M17/133

Assembly Procedure H

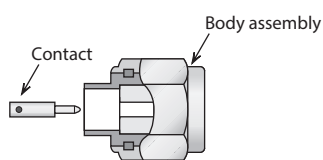

Trim Codes

Code	A
H/01	.090

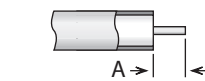

1) Trim cable as shown. Remove any burrs from jacket and center conductor.

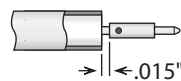

2) Solder contact to center conductor, fixturing to maintain gap as shown. Remove any excess solder from outside of contact.

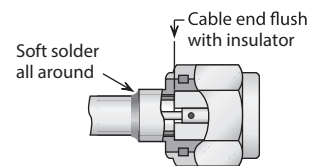

3) Insert cable into body and solder cable jacket to body, keeping end of cable flush with insulator as shown.

Plug body assembly and contact shown; procedure is identical for jack connectors.

Panel Receptacles - Post Contact

Jack Receptacles

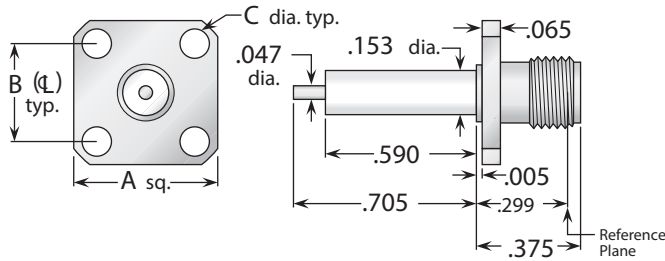

Figure 1 (1/2" square flange)

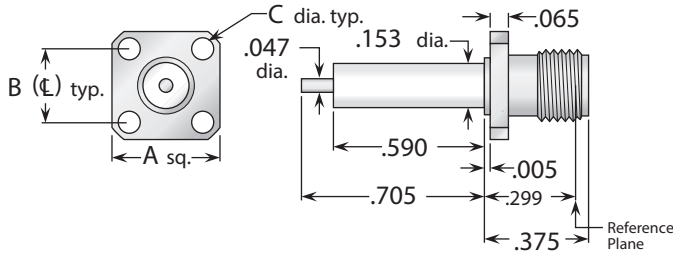

Figure 2 (3/8" square flange)

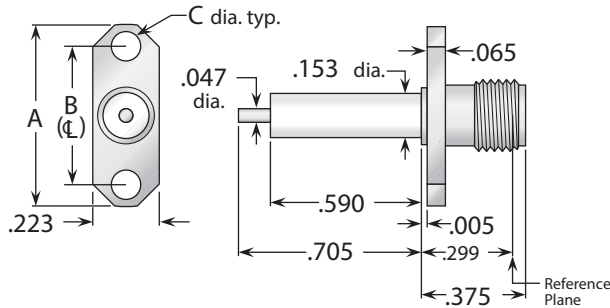

Figure 3 (2-hole flange)

Plug Receptacles

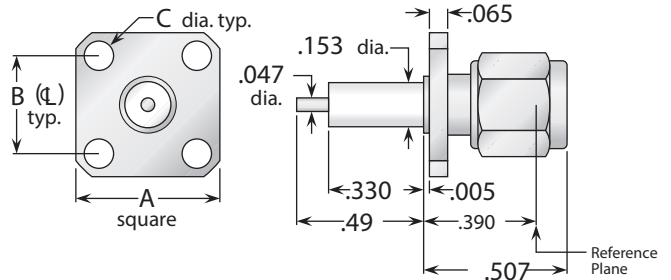

Figure 4 (1/2" square flange)

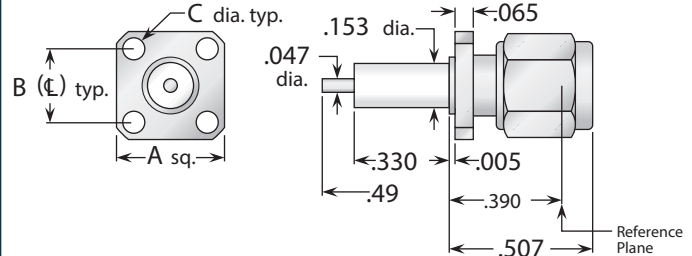

Figure 5 (3/8" square flange)

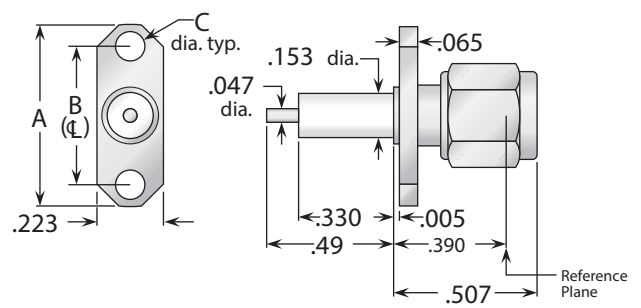

Figure 6 (2-hole flange)

Figure	Dimensions			Plating		Delta P/N
	A	B	C	Body	Contact	
1	.500	.340	.102	Gold	Gold (C)	1358000G051-900
1	.500	.340	.102	Passivated	Gold (C)	1358000K051-900
2	.375	.250	.067	Gold	Gold (C)	1358000G911-900
2	.375	.250	.067	Passivated	Gold (C)	1358000K911-900
3	.625	.481	.102	Gold	Gold (C)	1358000G921-900
3	.625	.481	.102	Passivated	Gold (C)	1358000K921-900
4	.500	.340	.102	Gold	Gold (C)	1359000G051-900
4	.500	.340	.102	Passivated	Gold (C)	1359000K051-900
5	.375	.250	.067	Gold	Gold (C)	1359000G911-900
5	.375	.250	.067	Passivated	Gold (C)	1359000K911-900
6	.625	.481	.102	Gold	Gold (C)	1359000G921-900
6	.625	.481	.102	Passivated	Gold (C)	1359000K921-900

These receptacles are also available with other flange sizes and contact / insulator configurations.
(C) in contact plating column indicates captive contact.

Panel Jack Receptacles - Field Replaceable, Air Dielectric (No EMI Gasket)

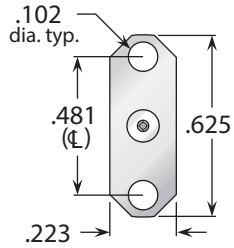

Figure 1
(Standard 2-hole flange)

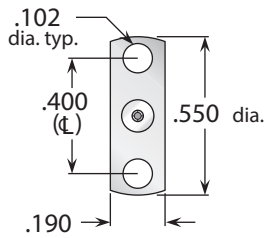
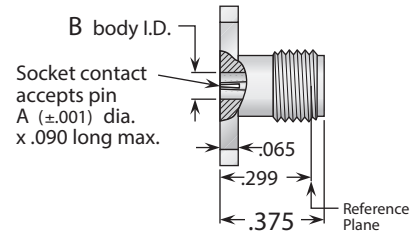

Figure 2
(Narrow 2-hole flange)



Connector Side View

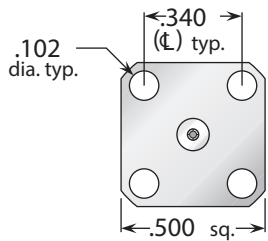

Figure 3
(1/2" square flange)

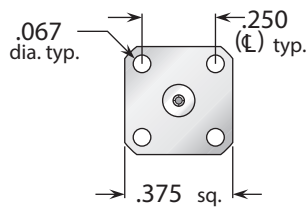

Figure 4
(3/8" square flange)

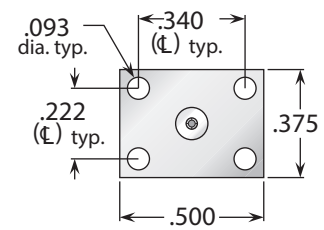

Figure 5
(1/2" x 3/8" rectangular flange)

Flange Figure	Dimensions		Plating		Delta P/N
	A (Pin Diameter)	B (Body I.D.)	Body	Contact	
1	.012	.078	Passivated	Gold (C)	1396000K921-025
	.015	.078	Passivated	Gold (C)	1396000K921-026
	.018	.078	Passivated	Gold (C)	1396000K921-027
	.020	.078	Passivated	Gold (C)	1396000K921-028
	.036	.110	Passivated	Gold (C)	1396000K921-029
2	.012	.078	Passivated	Gold (C)	1396000K911-029
	.015	.078	Passivated	Gold (C)	1396000K911-030
	.018	.078	Passivated	Gold (C)	1396000K911-031
	.020	.078	Passivated	Gold (C)	1396000K911-032
	.036	.110	Passivated	Gold (C)	1396000K911-033
3	.012	.078	Passivated	Gold (C)	1396000K051-015
	.015	.078	Passivated	Gold (C)	1396000K051-016
	.018	.078	Passivated	Gold (C)	1396000K051-017
	.020	.078	Passivated	Gold (C)	1396000K051-018
	.036	.110	Passivated	Gold (C)	1396000K051-019
4	.012	.078	Passivated	Gold (C)	1396000K911-023
	.015	.078	Passivated	Gold (C)	1396000K911-024
	.018	.078	Passivated	Gold (C)	1396000K911-025
	.020	.078	Passivated	Gold (C)	1396000K911-026
	.036	.110	Passivated	Gold (C)	1396000K911-027
5	.012	.078	Passivated	Gold (C)	1396000K911-042
	.015	.078	Passivated	Gold (C)	1396000K911-043
	.018	.078	Passivated	Gold (C)	1396000K911-044
	.020	.078	Passivated	Gold (C)	1396000K911-045
	.036	.110	Passivated	Gold (C)	1396000K911-046

See page 15 for accessory pins. • See page 16 for hermetic seals. • (C) indicates captive contact.

Panel Jack Receptacles - Field Replaceable, Air Dielectric (With EMI Gasket)

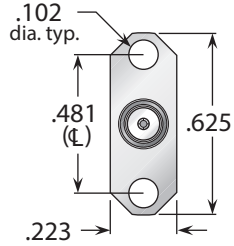

Figure 1
(Standard 2-hole flange)

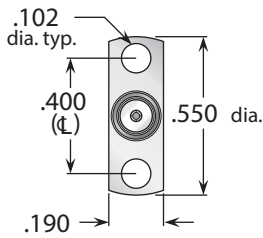
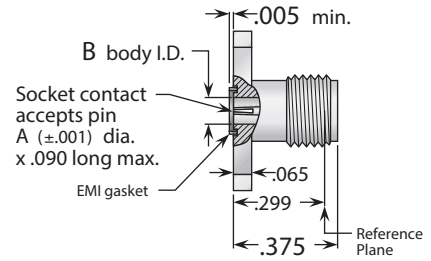

Figure 2
(Narrow 2-hole flange)



Connector Side View

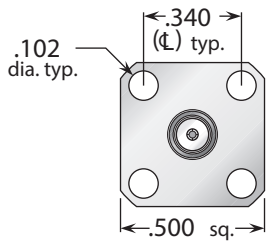

Figure 3
(1/2" square flange)

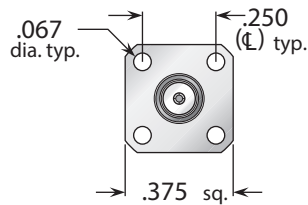

Figure 4
(3/8" square flange)

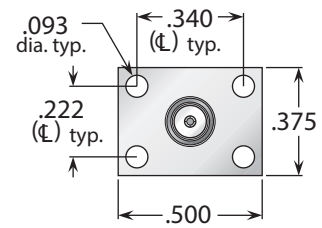

Figure 5
(1/2" x 3/8" rectangular flange)

Flange Figure	Dimensions		Plating		Delta P/N
	A (Pin Diameter)	B (Body I.D.)	Body	Contact	
1	.012	.078	Passivated	Gold (C)	1396000K921-025-EMI
	.015	.078	Passivated	Gold (C)	1396000K921-026-EMI
	.018	.078	Passivated	Gold (C)	1396000K921-027-EMI
	.020	.078	Passivated	Gold (C)	1396000K921-028-EMI
	.036	.110	Passivated	Gold (C)	1396000K921-029-EMI
2	.012	.078	Passivated	Gold (C)	1396000K911-029-EMI
	.015	.078	Passivated	Gold (C)	1396000K911-030-EMI
	.018	.078	Passivated	Gold (C)	1396000K911-031-EMI
	.020	.078	Passivated	Gold (C)	1396000K911-032-EMI
	.036	.110	Passivated	Gold (C)	1396000K911-033-EMI
3	.012	.078	Passivated	Gold (C)	1396000K051-015-EMI
	.015	.078	Passivated	Gold (C)	1396000K051-016-EMI
	.018	.078	Passivated	Gold (C)	1396000K051-017-EMI
	.020	.078	Passivated	Gold (C)	1396000K051-018-EMI
	.036	.110	Passivated	Gold (C)	1396000K051-019-EMI
4	.012	.078	Passivated	Gold (C)	1396000K911-023-EMI
	.015	.078	Passivated	Gold (C)	1396000K911-024-EMI
	.018	.078	Passivated	Gold (C)	1396000K911-025-EMI
	.020	.078	Passivated	Gold (C)	1396000K911-026-EMI
	.036	.110	Passivated	Gold (C)	1396000K911-027-EMI
5	.012	.078	Passivated	Gold (C)	1396000K911-042-EMI
	.015	.078	Passivated	Gold (C)	1396000K911-043-EMI
	.018	.078	Passivated	Gold (C)	1396000K911-044-EMI
	.020	.078	Passivated	Gold (C)	1396000K911-045-EMI
	.036	.110	Passivated	Gold (C)	1396000K911-046-EMI

See page 15 for accessory pins. • See page 16 for hermetic seals. • (C) indicates captive contact.

Panel Jack Receptacles - Field Replaceable, PTFE Dielectric (No EMI Gasket)

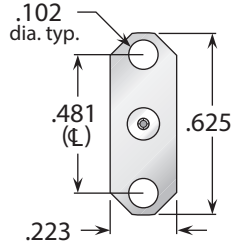

Figure 1
(Standard 2-hole flange)

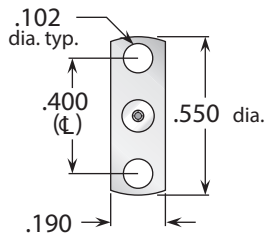
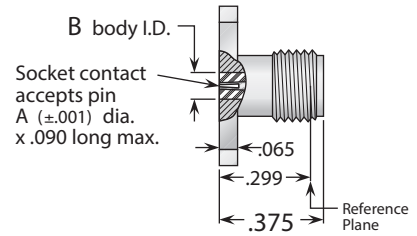

Figure 2
(Narrow 2-hole flange)



Connector Side View

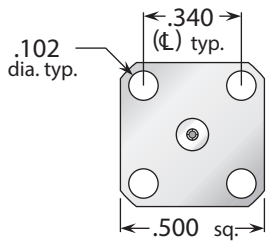

Figure 3
(1/2" square flange)

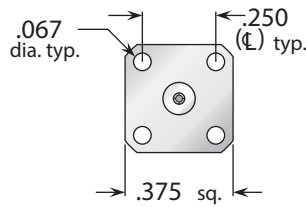

Figure 4
(3/8" square flange)

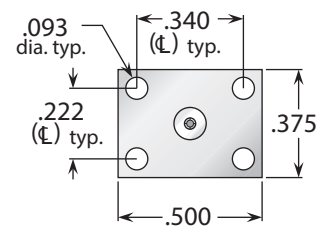

Figure 5
(1/2" x 3/8" rectangular flange)

Flange Figure	Dimensions		Plating		Delta P/N
	A (Pin Diameter)	B (Body I.D.)	Body	Contact	
1	.012	.104	Passivated	Gold (C)	1396000K921-021
	.015	.104	Passivated	Gold (C)	1396000K921-022
	.018	.104	Passivated	Gold (C)	1396000K921-023
	.020	.104	Passivated	Gold (C)	1396000K921-024
2	.012	.104	Passivated	Gold (C)	1396000K911-034
	.015	.104	Passivated	Gold (C)	1396000K911-035
	.018	.104	Passivated	Gold (C)	1396000K911-036
	.020	.104	Passivated	Gold (C)	1396000K911-037
3	.012	.104	Passivated	Gold (C)	1396000K051-020
	.015	.104	Passivated	Gold (C)	1396000K051-021
	.018	.104	Passivated	Gold (C)	1396000K051-022
	.020	.104	Passivated	Gold (C)	1396000K051-023
4	.012	.104	Passivated	Gold (C)	1396000K911-038
	.015	.104	Passivated	Gold (C)	1396000K911-039
	.018	.104	Passivated	Gold (C)	1396000K911-040
	.020	.104	Passivated	Gold (C)	1396000K911-041
5	.012	.104	Passivated	Gold (C)	1396000K911-047
	.015	.104	Passivated	Gold (C)	1396000K911-048
	.018	.104	Passivated	Gold (C)	1396000K911-049
	.020	.104	Passivated	Gold (C)	1396000K911-050

See page 15 for accessory pins. • See page 16 for hermetic seals. • (C) indicates captive contact.

Panel Jack Receptacles - Field Replaceable, PTFE Dielectric (With EMI Gasket)

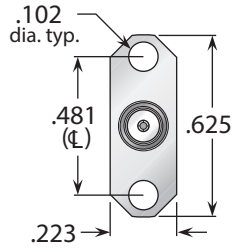

Figure 1
(Standard 2-hole flange)

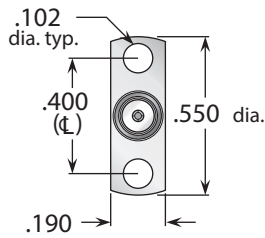
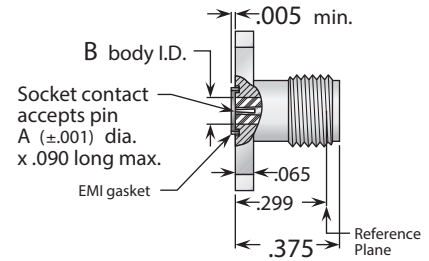

Figure 2
(Narrow 2-hole flange)



Connector Side View

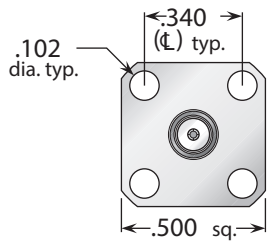

Figure 3
(1/2" square flange)

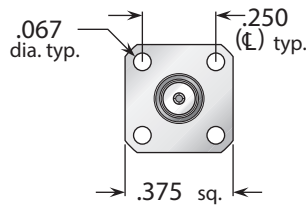

Figure 4
(3/8" square flange)

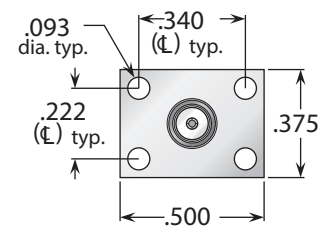

Figure 5
(1/2" x 3/8" rectangular flange)

Flange Figure	Dimensions		Plating		Delta P/N
	A (Pin Diameter)	B (Body I.D.)	Body	Contact	
1	.012	.104	Passivated	Gold (C)	1396000K921-021-EMI
	.015	.104	Passivated	Gold (C)	1396000K921-022-EMI
	.018	.104	Passivated	Gold (C)	1396000K921-023-EMI
	.020	.104	Passivated	Gold (C)	1396000K921-024-EMI
2	.012	.104	Passivated	Gold (C)	1396000K911-034-EMI
	.015	.104	Passivated	Gold (C)	1396000K911-035-EMI
	.018	.104	Passivated	Gold (C)	1396000K911-036-EMI
	.020	.104	Passivated	Gold (C)	1396000K911-037-EMI
3	.012	.104	Passivated	Gold (C)	1396000K051-020-EMI
	.015	.104	Passivated	Gold (C)	1396000K051-021-EMI
	.018	.104	Passivated	Gold (C)	1396000K051-022-EMI
	.020	.104	Passivated	Gold (C)	1396000K051-023-EMI
4	.012	.104	Passivated	Gold (C)	1396000K911-038-EMI
	.015	.104	Passivated	Gold (C)	1396000K911-039-EMI
	.018	.104	Passivated	Gold (C)	1396000K911-040-EMI
	.020	.104	Passivated	Gold (C)	1396000K911-041-EMI
5	.012	.104	Passivated	Gold (C)	1396000K911-047-EMI
	.015	.104	Passivated	Gold (C)	1396000K911-048-EMI
	.018	.104	Passivated	Gold (C)	1396000K911-049-EMI
	.020	.104	Passivated	Gold (C)	1396000K911-050-EMI

See page 15 for accessory pins. • See page 16 for hermetic seals. • (C) indicates captive contact.

Panel Plug Receptacles - Field Replaceable, PTFE Dielectric (With EMI Gasket)

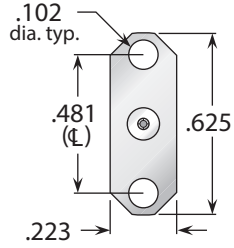

Figure 1
(Standard 2-hole flange)

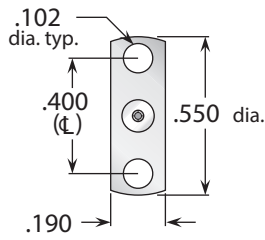
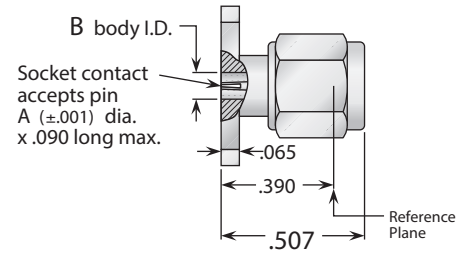

Figure 2
(Narrow 2-hole flange)



Connector Side View

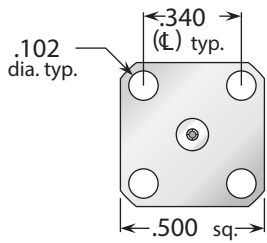

Figure 3
(1/2" square flange)

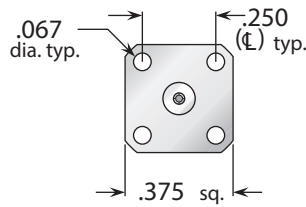

Figure 4
(3/8" square flange)

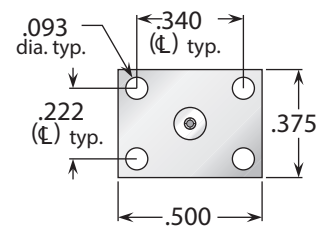

Figure 5
(1/2" x 3/8" rectangular flange)

Flange Figure	Dimensions		Plating		Delta P/N
	A (Pin Diameter)	B (Body I.D.)	Body	Contact	
1	.012	.078	Passivated	Gold (C)	1397000K921-017
	.015	.078	Passivated	Gold (C)	1397000K921-018
	.018	.078	Passivated	Gold (C)	1397000K921-019
	.020	.078	Passivated	Gold (C)	1397000K921-020
	.036	.110	Passivated	Gold (C)	1397000K921-021
2	.012	.078	Passivated	Gold (C)	1397000K911-011
	.015	.078	Passivated	Gold (C)	1397000K911-012
	.018	.078	Passivated	Gold (C)	1397000K911-013
	.020	.078	Passivated	Gold (C)	1397000K911-014
	.036	.110	Passivated	Gold (C)	1397000K911-015
3	.012	.078	Passivated	Gold (C)	1397000K051-011
	.015	.078	Passivated	Gold (C)	1397000K051-012
	.018	.078	Passivated	Gold (C)	1397000K051-013
	.020	.078	Passivated	Gold (C)	1397000K051-014
	.036	.110	Passivated	Gold (C)	1397000K051-015
4	.012	.078	Passivated	Gold (C)	1397000K911-020
	.015	.078	Passivated	Gold (C)	1397000K911-021
	.018	.078	Passivated	Gold (C)	1397000K911-022
	.020	.078	Passivated	Gold (C)	1397000K911-023
	.036	.110	Passivated	Gold (C)	1397000K911-024
5	.012	.078	Passivated	Gold (C)	1397000K911-029
	.015	.078	Passivated	Gold (C)	1397000K911-030
	.018	.078	Passivated	Gold (C)	1397000K911-031
	.020	.078	Passivated	Gold (C)	1397000K911-032
	.036	.110	Passivated	Gold (C)	1397000K911-033

See page 15 for accessory pins. • See page 16 for hermetic seals. • (C) indicates captive contact.

Panel Plug Receptacles - Field Replaceable, PTFE Dielectric (With EMI Gasket)

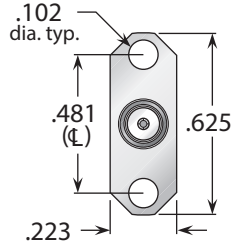

Figure 1
(Standard 2-hole flange)

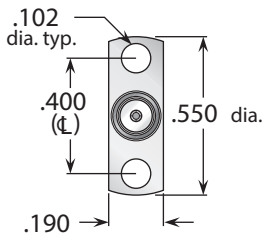
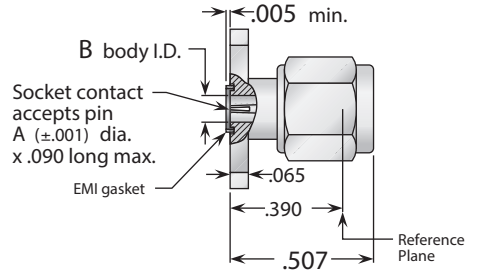

Figure 2
(Narrow 2-hole flange)



Connector Side View

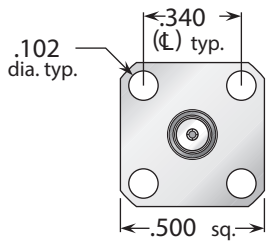

Figure 3
(1/2" square flange)

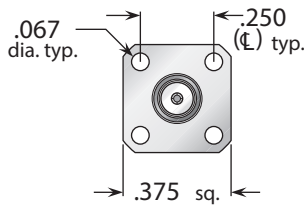

Figure 4
(3/8" square flange)

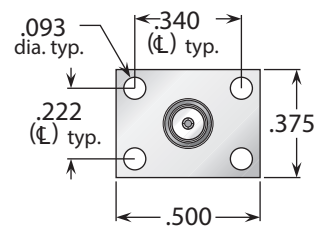

Figure 5
(1/2" x 3/8" rectangular flange)

Flange Figure	Dimensions		Plating		Delta P/N
	A (Pin Diameter)	B (Body I.D.)	Body	Contact	
1	.012	.078	Passivated	Gold (C)	1397000K921-017-EMI
	.015	.078	Passivated	Gold (C)	1397000K921-018-EMI
	.018	.078	Passivated	Gold (C)	1397000K921-019-EMI
	.020	.078	Passivated	Gold (C)	1397000K921-020-EMI
	.036	.110	Passivated	Gold (C)	1397000K921-021-EMI
2	.012	.078	Passivated	Gold (C)	1397000K911-011-EMI
	.015	.078	Passivated	Gold (C)	1397000K911-012-EMI
	.018	.078	Passivated	Gold (C)	1397000K911-013-EMI
	.020	.078	Passivated	Gold (C)	1397000K911-014-EMI
	.036	.110	Passivated	Gold (C)	1397000K911-015-EMI
3	.012	.078	Passivated	Gold (C)	1397000K051-011-EMI
	.015	.078	Passivated	Gold (C)	1397000K051-012-EMI
	.018	.078	Passivated	Gold (C)	1397000K051-013-EMI
	.020	.078	Passivated	Gold (C)	1397000K051-014-EMI
	.036	.110	Passivated	Gold (C)	1397000K051-015-EMI
4	.012	.078	Passivated	Gold (C)	1397000K911-020-EMI
	.015	.078	Passivated	Gold (C)	1397000K911-021-EMI
	.018	.078	Passivated	Gold (C)	1397000K911-022-EMI
	.020	.078	Passivated	Gold (C)	1397000K911-023-EMI
	.036	.110	Passivated	Gold (C)	1397000K911-024-EMI
5	.012	.078	Passivated	Gold (C)	1397000K911-029-EMI
	.015	.078	Passivated	Gold (C)	1397000K911-030-EMI
	.018	.078	Passivated	Gold (C)	1397000K911-031-EMI
	.020	.078	Passivated	Gold (C)	1397000K911-032-EMI
	.036	.110	Passivated	Gold (C)	1397000K911-033-EMI

See page 15 for accessory pins. • See page 16 for hermetic seals. • (C) indicates captive contact.

Panel Plug Receptacles - Field Replaceable, PTFE Dielectric (With EMI Gasket)

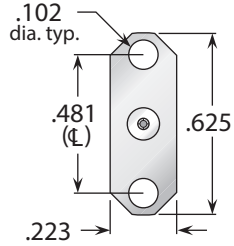

Figure 1
(Standard 2-hole flange)

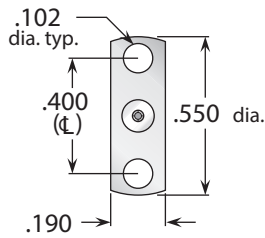
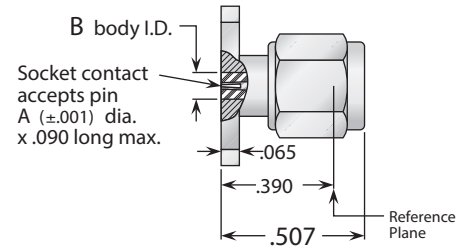

Figure 2
(Narrow 2-hole flange)



Connector Side View

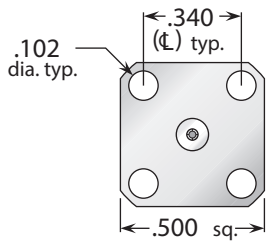

Figure 3
(1/2" square flange)

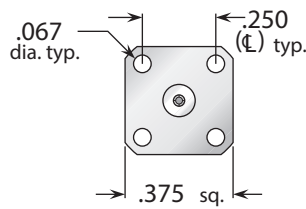

Figure 4
(3/8" square flange)

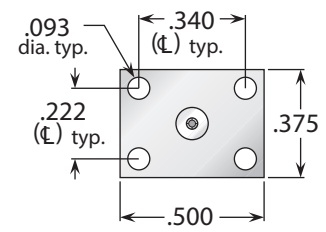

Figure 5
(1/2" x 3/8" rectangular flange)

Flange Figure	Dimensions		Plating		Delta P/N
	A (Pin Diameter)	B (Body I.D.)	Body	Contact	
1	.012	.104	Passivated	Gold (C)	1397000K921-022
	.015	.104	Passivated	Gold (C)	1397000K921-023
	.018	.104	Passivated	Gold (C)	1397000K921-024
	.020	.104	Passivated	Gold (C)	1397000K921-025
2	.012	.104	Passivated	Gold (C)	1397000K911-016
	.015	.104	Passivated	Gold (C)	1397000K911-017
	.018	.104	Passivated	Gold (C)	1397000K911-018
	.020	.104	Passivated	Gold (C)	1397000K911-019
3	.012	.104	Passivated	Gold (C)	1397000K051-016
	.015	.104	Passivated	Gold (C)	1397000K051-017
	.018	.104	Passivated	Gold (C)	1397000K051-018
	.020	.104	Passivated	Gold (C)	1397000K051-019
4	.012	.104	Passivated	Gold (C)	1397000K911-025
	.015	.104	Passivated	Gold (C)	1397000K911-026
	.018	.104	Passivated	Gold (C)	1397000K911-027
	.020	.104	Passivated	Gold (C)	1397000K911-028
5	.012	.104	Passivated	Gold (C)	1397000K911-034
	.015	.104	Passivated	Gold (C)	1397000K911-035
	.018	.104	Passivated	Gold (C)	1397000K911-036
	.020	.104	Passivated	Gold (C)	1397000K911-037

See page 15 for accessory pins. • See page 16 for hermetic seals. • (C) indicates captive contact.

Panel Plug Receptacles - Field Replaceable, PTFE Dielectric (With EMI Gasket)

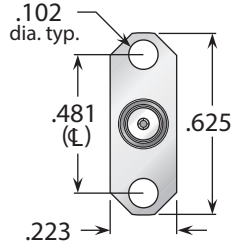

Figure 1
(Standard 2-hole flange)

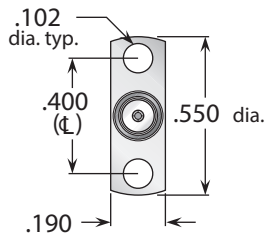
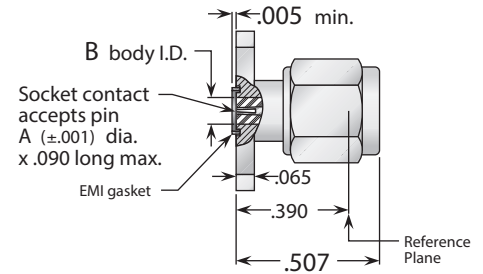

Figure 2
(Narrow 2-hole flange)



Connector Side View

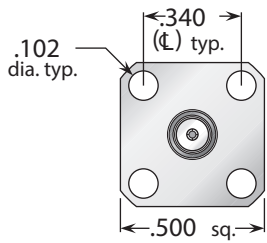

Figure 3
(1/2" square flange)

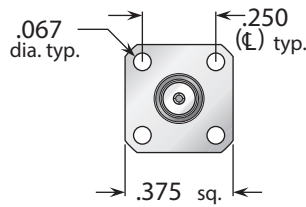

Figure 4
(3/8" square flange)

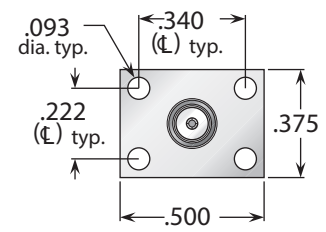

Figure 5
(1/2" x 3/8" rectangular flange)

Flange Figure	Dimensions		Plating		Delta P/N
	A (Pin Diameter)	B (Body I.D.)	Body	Contact	
1	.012	.104	Passivated	Gold (C)	1397000K921-022-EMI
	.015	.104	Passivated	Gold (C)	1397000K921-023-EMI
	.018	.104	Passivated	Gold (C)	1397000K921-024-EMI
	.020	.104	Passivated	Gold (C)	1397000K921-025-EMI
2	.012	.104	Passivated	Gold (C)	1397000K911-016-EMI
	.015	.104	Passivated	Gold (C)	1397000K911-017-EMI
	.018	.104	Passivated	Gold (C)	1397000K911-018-EMI
	.020	.104	Passivated	Gold (C)	1397000K911-019-EMI
3	.012	.104	Passivated	Gold (C)	1397000K051-016-EMI
	.015	.104	Passivated	Gold (C)	1397000K051-017-EMI
	.018	.104	Passivated	Gold (C)	1397000K051-018-EMI
	.020	.104	Passivated	Gold (C)	1397000K051-019-EMI
4	.012	.104	Passivated	Gold (C)	1397000K911-025-EMI
	.015	.104	Passivated	Gold (C)	1397000K911-026-EMI
	.018	.104	Passivated	Gold (C)	1397000K911-027-EMI
	.020	.104	Passivated	Gold (C)	1397000K911-028-EMI
5	.012	.104	Passivated	Gold (C)	1397000K911-034-EMI
	.015	.104	Passivated	Gold (C)	1397000K911-035-EMI
	.018	.104	Passivated	Gold (C)	1397000K911-036-EMI
	.020	.104	Passivated	Gold (C)	1397000K911-037-EMI

See page 15 for accessory pins. • See page 16 for hermetic seals. • (C) indicates captive contact.

Bulkhead Replaceable

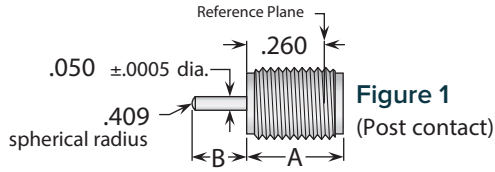

Figure 1
(Post contact)

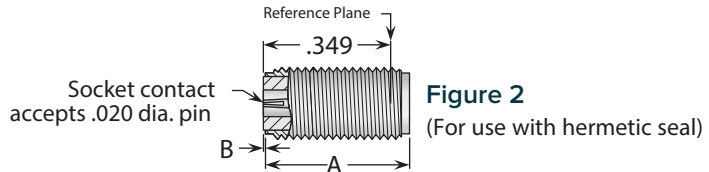

Figure 2
(For use with hermetic seal)

Figure	Dimensions		Plating		Delta P/N
	A	B	Body	Contact	
1	.336	.185	Gold	Gold (C)	1321000G821-900
1	.336	.185	Passivated	Gold (C)	1321000K821-900
2	.425	.002/.006	Gold	Gold (C)	1321000G821-901
2	.425	.002/.006	Passivated	Gold (C)	1321000K821-901

Straight Adapters

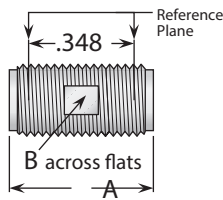

Figure 1 (Straight jack-jack; connects two plugs)

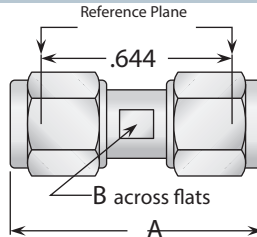

Figure 2 (Straight plug-plug; connects two jacks)

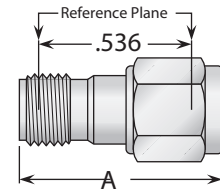

Figure 3 (Straight jack-plug; connects one plug and one jack)

Figure	Dimensions		Plating		Delta P/N
	A	B	Body	Contact	
1	.500	.218	Gold	Gold (C)	1328000G001-900
1	.500	.218	Passivated	Gold (C)	1328000K001-900
2	.875	.218	Gold	Gold (C)	1327000G001-900
2	.875	.218	Passivated	Gold (C)	1327000K001-900
3	.720	—	Gold	Gold (C)	1334000G001-900
3	.720	—	Passivated	Gold (C)	1334000K001-900

(C) indicates captive contact.

Accessory Pins

These drawings are 200% scale compared with connector drawings for clarity.
Pins are available with other tab sizes and configurations to suit your specific requirement.

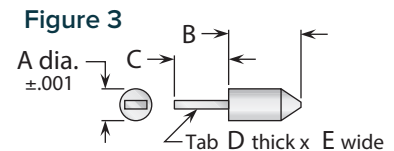
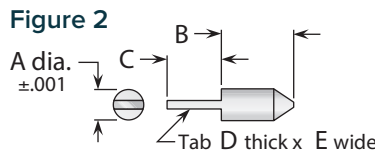
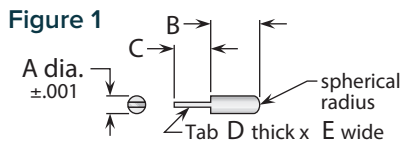

Material: Beryllium copper, Alloy C17300, condition H, per ASTM B196

Finish: Gold plated per MIL-G-45204 Type II, Class 1, Grade C, over nickel plate per AMS-QQ-N-290, Class 1, Grade G.

Figure	Dimensions					Delta P/N
	A	B	C	D	E	
1	.012	.050	.025	.005	.012	33-10432-01-AU
2	.015	.085	.040	.005	.015	33-10416-01-AU
2	.020	.090	.100	.005	.020	33-10415-01-AU
2	.036	.090	.100	.005	.036	33-10418-01-AU
3	.036	.090	.100	.005	.020	33-10417-01-AU

Hermetic Seals

These drawings are 200% scale compared with connector drawings for clarity.
Hermetic seals are available with other pin lengths to suit your specific requirement.

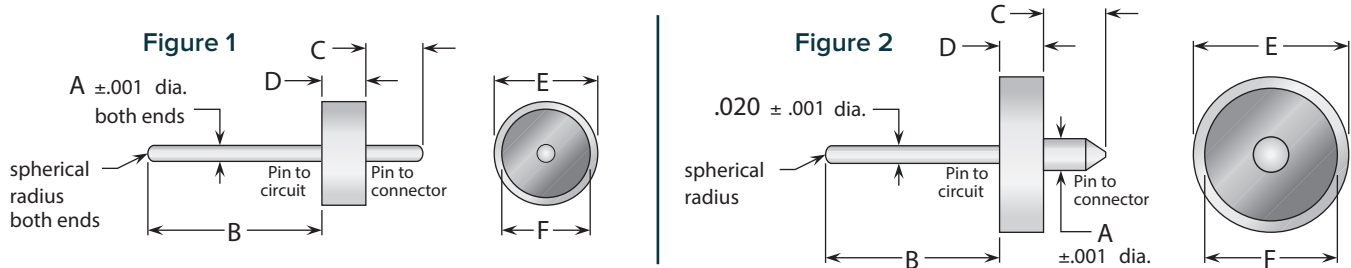

Ring and pin material: Kovar, gold plated per MIL-G-45204 Type II, Grade C, Class 1.
Leak Rate: $> 1 \times 10^{-8}$ cc/sec @ at 14.7 PSIG differential, using 100% helium. **Impedance:** $50 \pm 2 \Omega$.

Figure	Dimensions						Glass Type	Frequency Range	Delta P/N
	A	B	C	D	E	F			
1	.012	.180	.072	.063	.099	.078	7052	DC-42.0 GHz	41-10038-01-AU
1	.015	.180	.080	.063	.099	.083	7052	DC-28.0 GHz	41-10039-01-AU
1	.018	.180	.080	.063	.112	.099	7070	DC-18.0 GHz	41-10040-01-AU
1	.020	.180	.080	.063	.158	.129	7052	DC-8.0 GHz	41-10041-01-AU
2	.036	.180	.080	.063	.158	.129	7052	DC-8.0 GHz	41-10042-01-AU

Drilling For Hermetic Seals - Panel Mount Receptacles

Hermetic Seal P/N	Pin Dia.	Dimensions			
		A	B	C (Air)	C (TFE)
41-10038-01-AU	.012	.127	.102	.028	.040
41-10039-01-AU	.015	.127	.102	.035	.050
41-10040-01-AU	.018	.140	.115	.041	.059
41-10041-01-AU	.020	.188	.163	.046	.066
41-10042-01-AU	.036	.188	.163	.046	.066

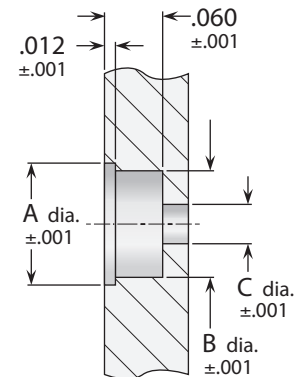

Note 1: Surface treatment (plating) must be compatible with soldering process.
Note 2: Front of seal and solder bead should be flush to .005" above mounting surface.

Replacement EMI Gasket

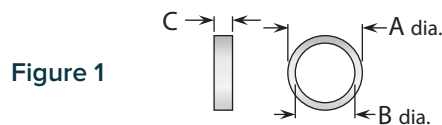

Material: Conductive elastomer per MIL-G-83528, Type F.

Figure	Dimensions			Used With	Delta P/N
	A	B	C		
1	.162	.127	.040	Connectors with narrow (.190" wide) 2-hole flange	53-10025-03-NP
1	.172	.140	.040	All other connectors	53-10025-02-NP

General Description

These high-performance SMA connectors feature maximum VSWR of 1.10:1 from DC to 18 GHz, and 1.15:1 from 18 to 27.0 GHz. They are designed to provide enhanced durability and reliability in a “field grade” production connector. Their interface dimensions meet MIL-STD-348 requirements for compatibility with all standard SMA type connectors

The internal design is optimized using state-of-the-art Electromagnetic Finite Element Analysis model simulation to provide low reflection coefficient, with mode free operation to 27.0 GHz.

In addition, this connector series provides -100 dB RF leakage due to the precision finish on the interface and mounting surfaces to assure a solid 360-degree contact in the critical RF return path, and the absence of epoxy holes in the connector body. The design of the internal structure provides a reliable and symmetrical axial captivation by mechanical means with a minimal disturbance to the transmission line characteristics and has a maximum continuous service temperature of 165° C.

SMA 27.0 GHz field replaceable connectors are available in six common mounting flange configurations. Both the field replaceable and thread-in (spark plug) connectors are available for use with hermetic seals or accessory pins with diameters of .009, .012, .015, .018, .020, and .036 inches. The standard hermetic seals and accessory pins on page 24 can be modified to a wide range of configurations to match your application requirements.

These connectors are machined to exacting tolerances and the highest quality standards on modern CNC turning centers, and assembly is tightly controlled and monitored to ensure peak consistency of performance from unit to unit.

Contents

Interface Dimensions and Specifications	18	Hermetic Seals.....	25
Field Replaceable Panel Jack Receptacles—		Accessory pins.....	25
Square and Rectangular Flanges	19	Drilling Dimensions for Hermetic Seals—	
Two-Hole Flanges	20	For Panel Mount Connectors	26
Field Replaceable Panel Plug Receptacles—		For Thread-in Connectors	26
Square and Rectangular Flanges.....	21	Drilling Dimensions—	
Two-Hole Flanges	22	Panel-Mount Receptacles.....	27
Thread-in (“Spark Plug”) Receptacles—		Competitive Cross-Reference	31
Field Replaceable.....	23	Index by Part Number.....	32
Post Contact.....	23		
Adapters Within Series.....	24		

Test Data

Test Setup

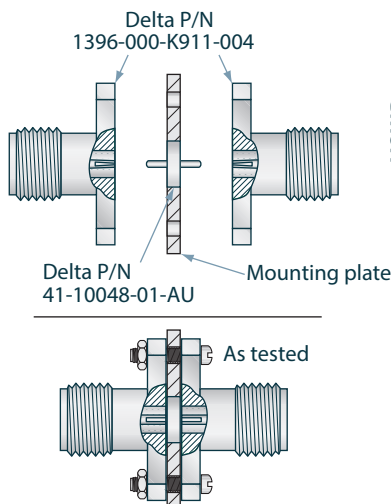

VSWR

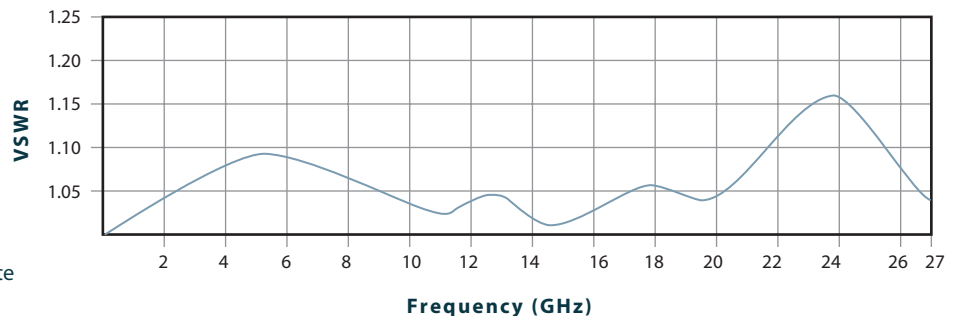

Two connectors tested, mounted back-to-back with a hermetic seal as shown at left. Maximum VSWR 1.16:1 @ 24 GHz (1.08:1 for each connector.)

These results are typical and valid only for connectors set up for testing in the configuration shown. Hermetic seal attachment method and other circuitry characteristics will affect VSWR of the completed component.

See next page for interface dimensions and specifications.

SMA 27.0 GHz Interfaces

Plug Interface**

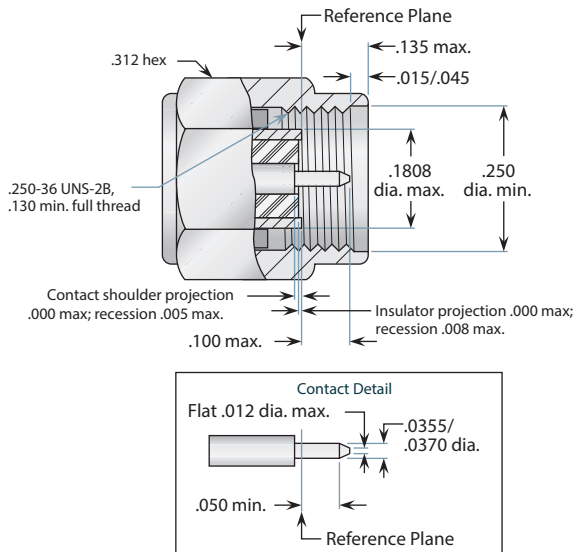

Jack Interface**

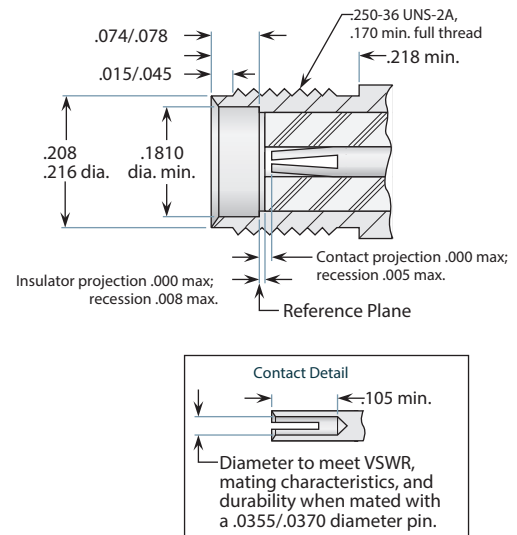

** Per MIL-STD-348, figures 310-1 and 310-2. Some proportions altered to illustrate detail.

SMA 27.0 GHz Specifications*

Electrical:

Nominal Impedance: 50 ohms.

Frequency Range: DC–27.0 GHz.

Voltage Rating: 335 Volts RMS (@ sea level).

VSWR: DC–18 GHz: 1.10:1 maximum;

18–27.0 GHz: 1.15:1 maximum.

RF Transmission Loss: $.03 \times \sqrt{f \text{ (GHz)}}$ dB.

Dielectric Withstanding Voltage: 1000 Volts RMS (@ sea level).

RF Hipot: 670 Volts RMS minimum @5 MHz.

Insulation Resistance: 5,000 megohms minimum.

RF Leakage: -100 dB minimum @3.0 GHz.

Contact Resistance: Center contact: 3.0 milliohms maximum;
Outer contact: 2.0 milliohms maximum.

Mechanical:

Force to Engage: 2 inch-pounds maximum.

Coupling Nut Retention: 60 pounds minimum (plugs only).

Coupling Proof Torque: 15 inch-pounds minimum (plugs only).

Contact Insertion Force: Insertion: 2 pounds maximum;
withdrawal: 2 ounces minimum.

Durability: 500 mating cycles minimum.

Mating Torque: 7–10 inch-pounds.

Materials/Finishes:

Insulators: Ultem[®] 1000 (PEI) per ASTM D5205, and Teflon[®] PTFE per ASTM D1710.

Contacts: Beryllium Copper (Alloy C17300) per ASTM B196.

Contact Plating: Gold per MIL-G-45204.

Other Metal Parts: Type 303 Stainless steel per ASTM A582, passivated per AMS-QQ-P-35, or gold plated per MIL-G-45204.

Gaskets (plugs): Silicone rubber per A-A-59588.

All materials meet outgassing requirements of NASA Publication 1124.

Environmental:

Operating Temperature: -65 to +165° C.

Vibration: Per MIL-STD-202, Method 204, test condition D.

Shock: Per MIL-STD-202, Method 213, test condition I.

Thermal Shock: Per MIL-STD-202, Method 107, test condition A.

Corrosion (Salt Atmosphere): Per MIL-STD-202, Method 101, test condition B.

Moisture Resistance: Per MIL-STD-202, Method 106, no measurements at high humidity. Insulation resistance 200 megohms minimum within 5 minutes of removal from humidity.

All other specifications are in accordance with the latest issues of MIL-PRF-39012, or MIL-PRF-55339, or other applicable MIL specifications, and interfaces are in accordance with MIL-STD-348.

*These specifications are typical and may not apply to all connectors. Detailed specifications for individual connectors are available on request.

Panel Jack Receptacles - Field Replaceable, Square and Rectangular Flange

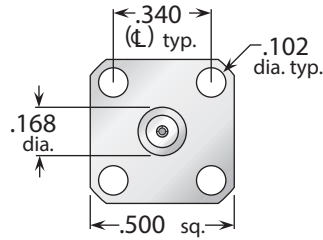
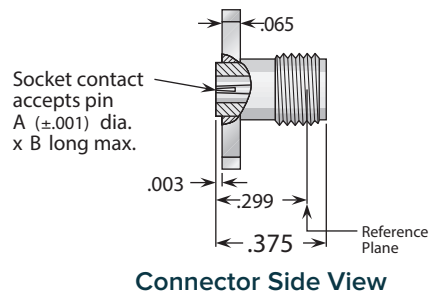

Figure 1
(1/2" square flange)



Connector Side View

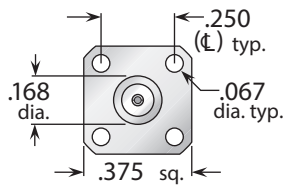

Figure 2
(3/8" square flange)

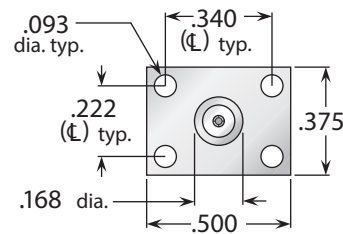

Figure 3
(1/2" x 3/8" rectangular flange)

Flange Figure	Dimensions		Plating		Delta P/N
	A (Pin Diameter)	B (Pin Length)	Body	Contact	
1	.009	.070	Passivated	Gold (C)	1396000K051-024
	.012	.090	Passivated	Gold (C)	1396000K051-006
	.015	.090	Passivated	Gold (C)	1396000K051-007
	.018	.095	Passivated	Gold (C)	1396000K051-008
	.020	.095	Passivated	Gold (C)	1396000K051-009
	.036	.100	Passivated	Gold (C)	1396000K051-010
2	.009	.070	Passivated	Gold (C)	1396000K911-075
	.012	.090	Passivated	Gold (C)	1396000K911-001
	.015	.090	Passivated	Gold (C)	1396000K911-002
	.018	.095	Passivated	Gold (C)	1396000K911-003
	.020	.095	Passivated	Gold (C)	1396000K911-004
	.036	.100	Passivated	Gold (C)	1396000K911-005
3	.009	.070	Passivated	Gold (C)	1396000K911-076
	.012	.090	Passivated	Gold (C)	1396000K911-006
	.015	.090	Passivated	Gold (C)	1396000K911-007
	.018	.095	Passivated	Gold (C)	1396000K911-008
	.020	.095	Passivated	Gold (C)	1396000K911-009
	.036	.100	Passivated	Gold (C)	1396000K911-010

See page 25 for hermetic seals and accessory pins. • (C) indicates captive contact.

Panel Jack Receptacles - Field Replaceable, 2-Hole Flange

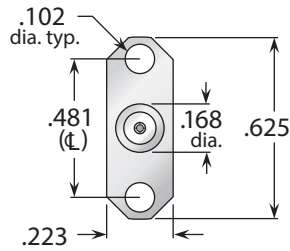
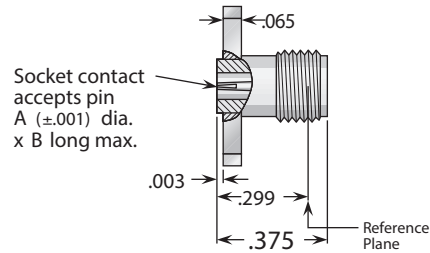

Figure 1
(Standard 2-Hole Flange)



Connector Side View

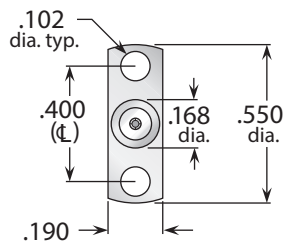

Figure 2
(Narrow 2-Hole Flange)

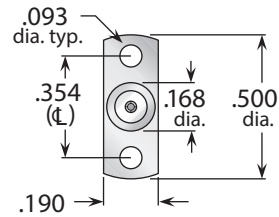

Figure 3
(Miniature 2-Hole Flange)

Flange Figure	Dimensions		Plating		Delta P/N
	A (Pin Diameter)	B (Pin Length)	Body	Contact	
1	.009	.070	Passivated	Gold (C)	1396000K921-031
	.012	.090	Passivated	Gold (C)	1396000K921-011
	.015	.090	Passivated	Gold (C)	1396000K921-012
	.018	.095	Passivated	Gold (C)	1396000K921-013
	.020	.095	Passivated	Gold (C)	1396000K921-014
	.036	.100	Passivated	Gold (C)	1396000K921-015
2	.009	.070	Passivated	Gold (C)	1396000K911-073
	.012	.090	Passivated	Gold (C)	1396000K911-051
	.015	.090	Passivated	Gold (C)	1396000K911-052
	.018	.095	Passivated	Gold (C)	1396000K911-053
	.020	.095	Passivated	Gold (C)	1396000K911-054
3	.009	.070	Passivated	Gold (C)	1396000K911-074
	.012	.090	Passivated	Gold (C)	1396000K911-055
	.015	.090	Passivated	Gold (C)	1396000K911-056
	.018	.095	Passivated	Gold (C)	1396000K911-057
	.020	.095	Passivated	Gold (C)	1396000K911-058

See page 25 for hermetic seals and accessory pins. • (C) indicates captive contact.

Panel Plug Receptacles - Field Replaceable, Square and Rectangular Flange

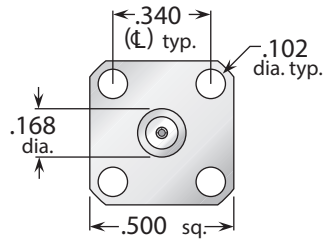
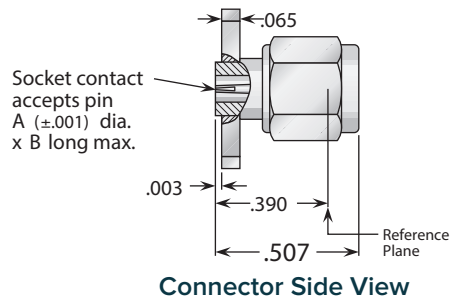

Figure 1
(1/2" Square Flange)



Connector Side View

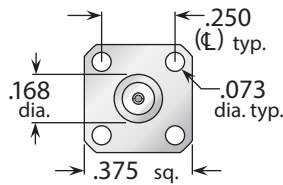

Figure 2
(3/8" Square Flange)

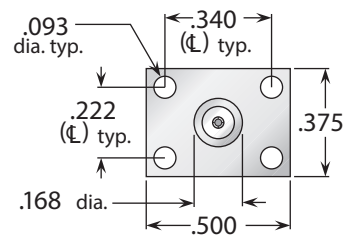

Figure 3
(1/2" x 3/8" rectangular Flange)

Flange Figure	Dimensions		Plating		Delta P/N
	A (Pin Diameter)	B (Pin Length)	Body	Contact	
1	.009	.070	Passivated	Gold (C)	1397000K051-024
	.012	.090	Passivated	Gold (C)	1397000K051-006
	.015	.090	Passivated	Gold (C)	1397000K051-007
	.018	.095	Passivated	Gold (C)	1397000K051-008
	.020	.095	Passivated	Gold (C)	1397000K051-009
	.036	.100	Passivated	Gold (C)	1397000K051-010
2	.009	.070	Passivated	Gold (C)	1397000K911-065
	.012	.090	Passivated	Gold (C)	1397000K911-001
	.015	.090	Passivated	Gold (C)	1397000K911-002
	.018	.095	Passivated	Gold (C)	1397000K911-003
	.020	.095	Passivated	Gold (C)	1397000K911-004
	.036	.100	Passivated	Gold (C)	1397000K911-005
3	.009	.070	Passivated	Gold (C)	1397000K911-066
	.012	.090	Passivated	Gold (C)	1397000K911-006
	.015	.090	Passivated	Gold (C)	1397000K911-007
	.018	.095	Passivated	Gold (C)	1397000K911-008
	.020	.095	Passivated	Gold (C)	1397000K911-009
	.036	.100	Passivated	Gold (C)	1397000K911-010

See page 25 for hermetic seals and accessory pins. • (C) indicates captive contact.

Panel Plug Receptacles - Field Replaceable, 2-Hole Flange

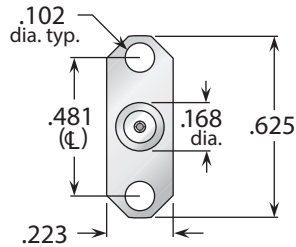
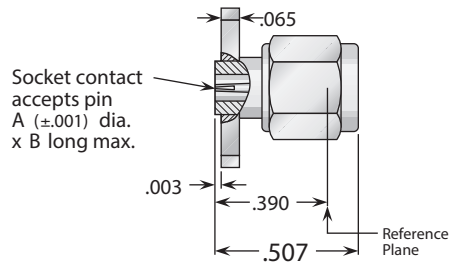

Figure 1
(Standard 2-hole flange)



Connector Side View

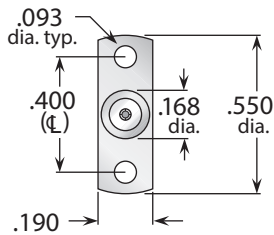

Figure 2
(Narrow 2-hole flange)

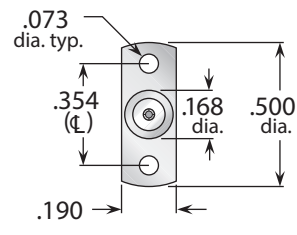

Figure 3
(Miniature 2-hole flange)

Flange Figure	Dimensions		Plating		Delta P/N
	A (Pin Diameter)	B (Pin Length)	Body	Contact	
1	.009	.070	Passivated	Gold (C)	1397000K921-030
	.012	.090	Passivated	Gold (C)	1397000K921-011
	.015	.090	Passivated	Gold (C)	1397000K921-012
	.018	.095	Passivated	Gold (C)	1397000K921-013
	.020	.095	Passivated	Gold (C)	1397000K921-014
	.036	.100	Passivated	Gold (C)	1397000K921-015
2	.009	.070	Passivated	Gold (C)	1397000K911-063
	.012	.090	Passivated	Gold (C)	1397000K911-038
	.015	.090	Passivated	Gold (C)	1397000K911-039
	.018	.095	Passivated	Gold (C)	1397000K911-040
	.020	.095	Passivated	Gold (C)	1397000K911-041
3	.009	.070	Passivated	Gold (C)	1397000K911-064
	.012	.090	Passivated	Gold (C)	1397000K911-042
	.015	.090	Passivated	Gold (C)	1397000K911-043
	.018	.095	Passivated	Gold (C)	1397000K911-044
	.020	.095	Passivated	Gold (C)	1397000K911-045

See page 25 for hermetic seals and accessory pins. • (C) indicates captive contact.

Thread-in Receptacles - Field Replaceable, Jacks and Plugs

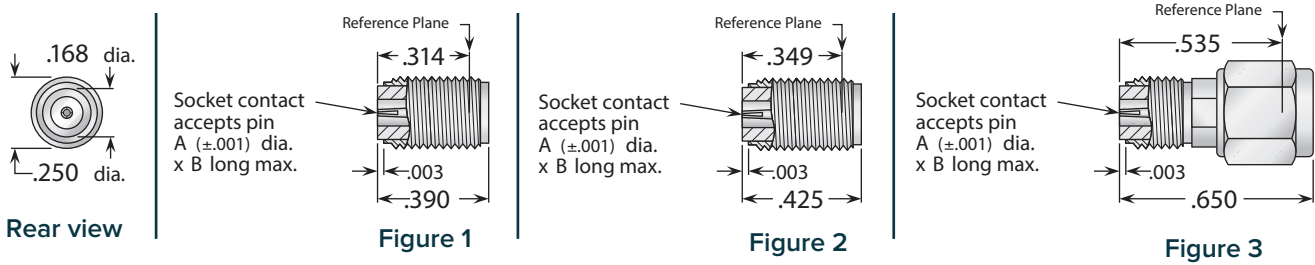

Figure	Dimensions		Plating		Delta P/N
	A (Pin Diameter)	B (Pin Length)	Body	Contact	
1	.012	.090	Passivated	Gold (C)	1396000K821-001
	.015	.090	Passivated	Gold (C)	1396000K821-002
	.018	.095	Passivated	Gold (C)	1396000K821-003
	.020	.095	Passivated	Gold (C)	1396000K821-004
2	.009	.070	Passivated	Gold (C)	1396000K821-022
	.012	.090	Passivated	Gold (C)	1396000K821-005
	.015	.090	Passivated	Gold (C)	1396000K821-006
	.018	.095	Passivated	Gold (C)	1396000K821-007
	.020	.095	Passivated	Gold (C)	1396000K821-008
3	.036	.100	Passivated	Gold (C)	1396000K821-009
	.009	.070	Passivated	Gold (C)	1397000K821-006
	.012	.090	Passivated	Gold (C)	1397000K821-001
	.015	.090	Passivated	Gold (C)	1397000K821-002
	.018	.095	Passivated	Gold (C)	1397000K821-003
	.020	.095	Passivated	Gold (C)	1397000K821-004
	.036	.100	Passivated	Gold (C)	1397000K821-005

Thread-in Jack Field Receptacles - Post Contact

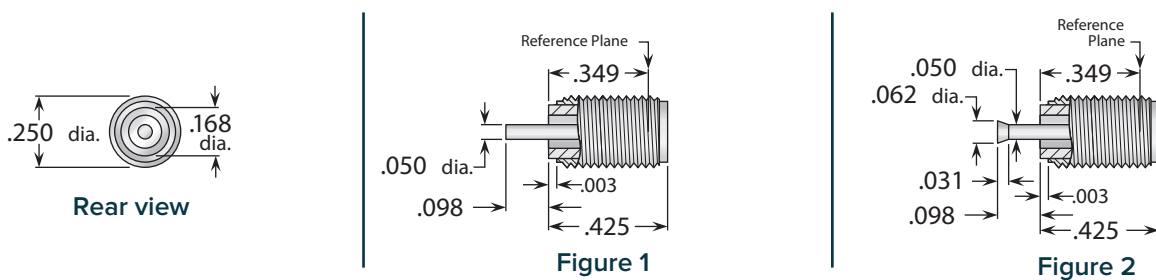

Figure	Contact Type	Plating		Delta P/N
		Body	Contact	
1	Straight	Passivated	Gold (C)	1321000K821-129
2	Flared	Passivated	Gold (C)	1321000K821-128

See page 25 for hermetic seals and accessory pins. • (C) indicates captive contact.

Straight Adapters

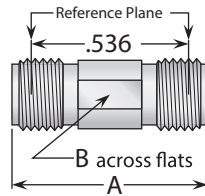

Figure 1

(Straight jack-jack; connects two plugs)

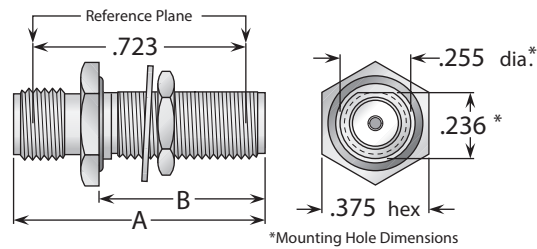

Figure 2

(Bulkhead jack-jack; connects two plugs)

Fits panel .250" thick maximum

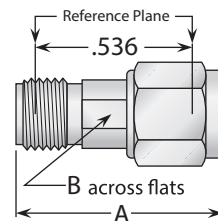

Figure 3

(Straight jack-plug; connects one plug and one jack)

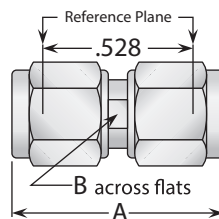

Figure 4

(Straight plug-plug; connects two jacks)

Figure	Dimensions		Plating		Delta P/N
	A	B	Body	Contact	
1	.688	.218	Passivated	Gold (C)	1328000K001-902
2	.875	.500	Passivated	Gold (C)	1326000K671-900
3	.728	.218	Passivated	Gold (C)	1334000K001-901
4	.759	.218	Passivated	Gold (C)	1327000K001-901

(C) indicates captive contact.

Hermetic Seals

These drawings are 200% scale compared with connector drawings for clarity.
Hermetic seals are available with other pin lengths to suit your specific requirement.

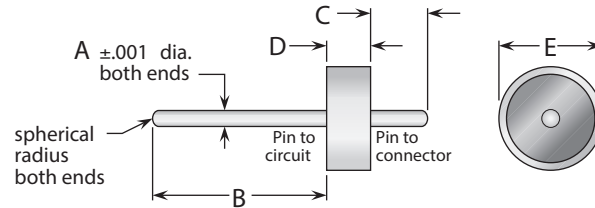

Ring and pin material: Kovar, gold plated per MIL-G-45204 Type II, Grade C, Class 1.
Leak rate: $>1 \times 10^{-8}$ cc/sec @at 14.7 PSIG differential, using 100% helium. Impedance: $50 \pm 2 \Omega$.

Dimensions					Glass Type	Frequency Range	Delta P/N
A	B	C	D	E			
.009	.026	.031	.055	.068	7070	DC-65.0 GHz	41-10050-01-AU
.009	.120	.031	.055	.068	7070	DC-65.0 GHz	41-10051-01-AU
.012	.180	.073	.069	.076	7070	DC-42.0 GHz	41-10044-01-AU
.012	.080	.040	.055	.076	7070	DC-42.0 GHz	41-10045-01-AU
.012	.029	.040	.055	.076	7070	DC-42.0 GHz	41-10049-01-AU
.015	.125	.050	.062	.098	7070	DC-28.0 GHz	41-10046-01-AU
.018	.180	.072	.060	.110	7070	DC-18.0 GHz	41-10047-01-AU
.020	.125	.050	.060	.158	7052	DC-8.0 GHz	41-10048-01-AU

Accessory Pins

These drawings are 200% scale compared with connector drawings for clarity.
Pins are available with other tab sizes and configurations to suit your specific requirement.

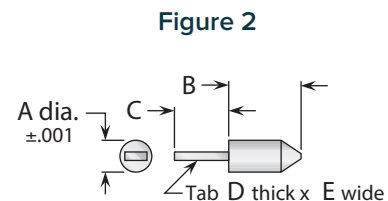
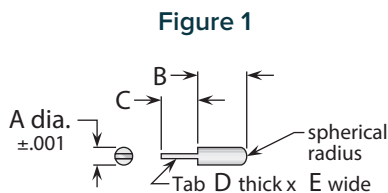

Material: Beryllium copper, Alloy C17300, condition H, per ASTM B196
Finish: Gold plated per MIL-G-45204 Type II, Class 1, Grade C, over nickel plate per AMS-QQ-N-290, Class 1, Grade G.

Figure	Dimensions					Delta P/N
	A	B	C	D	E	
1	.009	.050	.015	.005	.009	81-10293-01-AU
1	.012	.050	.025	.005	.012	33-10432-01-AU
1	.015	.085	.040	.005	.015	33-10416-01-AU
1	.018	.085	.045	.005	.018	81-10294-01-AU
1	.020	.080	.050	.006	.020	81-10260-01-AU
2	.036	.075	.050	.005	.020	81-10275-01-AU

Drilling For Hermetic Seals - Panel Mount Receptacles

Hermetic Seal P/N	Pin Dia.	Dimensions					
		A	B	C	D	E	F
41-10044-01-AU	.012	.0035/.0025	.072/.071	.028/.027	.067/.065	.079/.078	.098
41-10045-01-AU	.012	.0035/.0025	.057/.056	.028/.027	.067/.065	.079/.078	.098
41-10046-01-AU	.015	.007/.005	.0645/.0635	.035/.034	.080/.078	.102/.100	.120
41-10047-01-AU	.018	.009/.007	.062/.061	.042/.041	.086/.084	.113/.112	.130
41-10048-01-AU	.020	.010/.009	.062/.061	.0465/.0455	.126/.124	.161/.160	.178
41-10049-01-AU	.012	.0035/.0025	.057/.056	.028/.027	.067/.065	.079/.078	.098
41-10050-01-AU	.009	.008/.006	.058/.057	.0211/.0205	.0322/.0302	.074/.072	.091
41-10051-01-AU	.009	.008/.006	.058/.057	.0211/.0205	.0322/.0302	.074/.072	.091

Note 1: Surface treatment (plating) must be compatible with soldering process.
 Note 2: User-determined. Recommended F diameter x .025 deep to accommodate 3 solder rings, .010 diameter each.

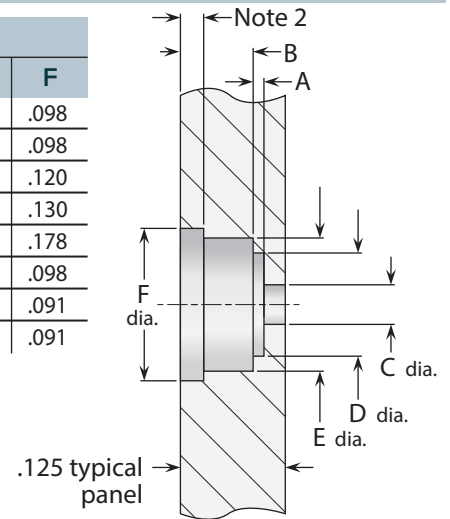

Drilling For Hermetic Seals - Bulkhead Mount Receptacles

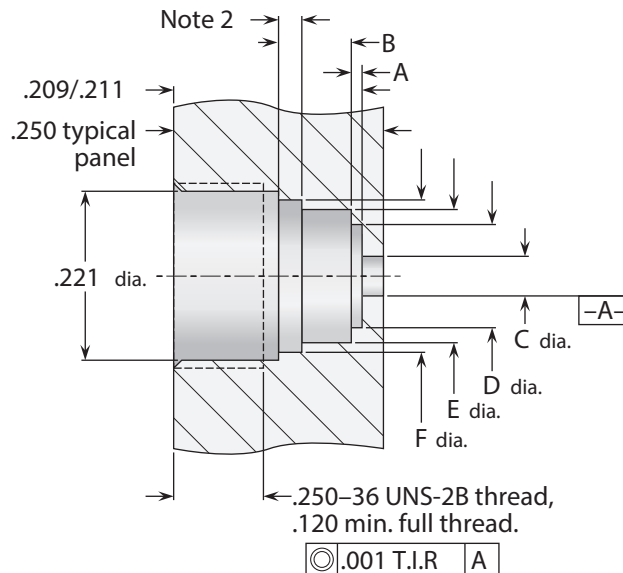

Hermetic Seal P/N	Pin Dia.	Dimensions					
		A	B	C	D	E	F
41-10044-01-AU	.012	.0035/.0025	.072/.071	.028/.027	.067/.065	.079/.078	.098
41-10045-01-AU	.012	.0035/.0025	.057/.056	.028/.027	.067/.065	.079/.078	.098
41-10046-01-AU	.015	.007/.005	.0645/.0635	.035/.034	.080/.078	.102/.100	.120
41-10047-01-AU	.018	.009/.007	.062/.061	.042/.041	.086/.084	.113/.112	.130
41-10048-01-AU	.020	.010/.009	.062/.061	.0465/.0455	.126/.124	.161/.160	.178
41-10049-01-AU	.012	.0035/.0025	.057/.056	.028/.027	.067/.065	.079/.078	.098
41-10050-01-AU	.009	.008/.006	.058/.057	.0211/.0205	.0322/.0302	.074/.072	.091
41-10051-01-AU	.009	.008/.006	.058/.057	.0211/.0205	.0322/.0302	.074/.072	.091

Note 1: Surface treatment (plating) must be compatible with soldering process.
 Note 2: User-determined. Recommended F diameter x .025 deep to accommodate 3 solder rings, .010 diameter each.

Drilling Patterns - Panel Mount Receptacles

2-Hole Flanges

Standard 2-hole flange

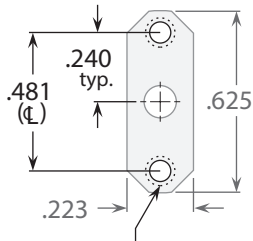

For jacks and plugs:
 #2-56 thread, 2 places.

Narrow 2-hole flange

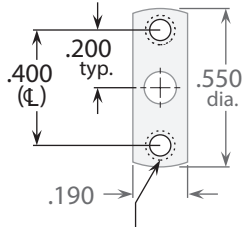

For jacks:
 #2-56 thread, 2 places.
 For plugs:
 #1-72 thread, 2 places.

Miniature 2-hole flange

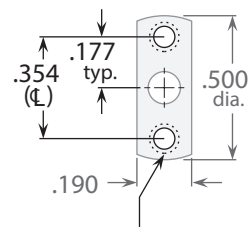

For jacks:
 #1-72 thread, 2 places.
 For plugs:
 #0-80 thread, 2 places,
 .125 max. screw length.

4-Hole Flanges

1/2" Square flange

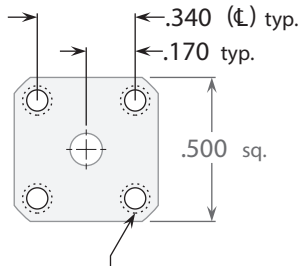

For jacks and plugs:
 #2-56 thread, 4 places.

3/8" Square flange

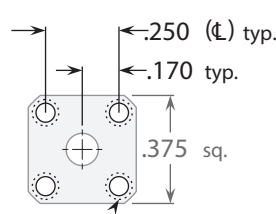

For jacks:
 #0-80 thread, 4 places.
 For plugs:
 #0-80 thread, 4 places,
 .125 max. screw length.

1/2 X 3/8" Rectangular flange

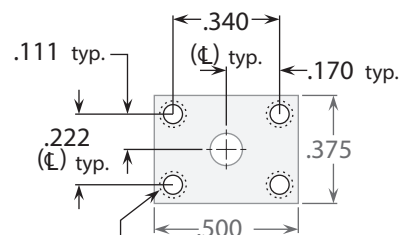

For jacks and plugs:
 #1-72 thread, 4 places.

Fillister-head screws are recommended for connector body clearance when mounting.
 See next page for center hole drilling dimensions.

Competitive Cross Reference - 26.5-GHz SMA Connectors

Please note that these connectors are *functional equivalents* to the competitor part numbers shown. If you are using a competitor's connector in a critical application, please contact us for engineering assistance and samples to determine the compatibility of our connectors with your application.

AEP P/N	Delta P/N	Dynawave P/N	Delta P/N
920-55.....	41-10038-01-AU	9854-0781-6220	1397000K051-018-EMI
920-56.....	41-10040-01-AU	9854-0781-6220	1397000K051-019-EMI
920-69.....	41-10041-01-AU	9854-0781-6227	1397000K911-027-EMI
920-82.....	41-10039-01-AU	9854-0781-6227	1397000K911-028-EMI
920-92.....	41-10042-01-AU	9952-0081-6214	1396000K911-034
9044-9513-000	1396000K921-021-EMI	9952-0081-6214	1396000K911-035
9044-9513-001	1396000K921-022-EMI	9952-0081-6215	1396000K921-021
9045-9513-000	1396000K051-020-EMI	9952-0081-6215	1396000K921-022
9045-9513-001	1396000K051-021-EMI	9952-0081-6220	1396000K921-023
9046-9513-000	1397000K921-022-EMI	9952-0081-6220	1396000K921-024
9046-9513-001	1397000K921-023-EMI	9952-0081-6224	1396000K911-036
9047-9513-000	1397000K051-016-EMI	9952-0081-6224	1396000K911-037
9047-9513-001	1397000K051-017-EMI	9952-0781-6214	1396000K911-034-EMI
9048-9513-000	1396000K921-023-EMI	9952-0781-6214	1396000K911-035-EMI
9049-9513-000	1396000K051-022-EMI	9952-0781-6215	1396000K921-021-EMI
9050-9513-000	1397000K921-024-EMI	9952-0781-6215	1396000K921-022-EMI
9051-9513-000	1397000K051-018	9952-0781-6220	1396000K921-023-EMI
9051-9513-000	1397000K051-018-EMI	9952-0781-6220	1396000K921-024-EMI
9062-9513-000	1396000K911-047-EMI	9952-0781-6224	1396000K911-036-EMI
9062-9513-001	1396000K911-048-EMI	9952-0781-6224	1396000K911-037-EMI
9068-9513-000	1396000K911-049-EMI	9954-0081-6215	1396000K051-020
9074-9513-000	1396000K911-040-EMI	9954-0081-6215	1396000K051-021
9079-9513-000	1396000K911-038-EMI	9954-0081-6217	1396000K911-038
9079-9513-001	1396000K911-039-EMI	9954-0081-6217	1396000K911-039
9080-9513-000	1396000K911-034-EMI	9954-0081-6219	1396000K911-047
9080-9513-001	1396000K911-035-EMI	9954-0081-6219	1396000K911-048
9081-9513-000	1396000K911-036-EMI	9954-0081-6220	1396000K051-022
9504-9113-031	1396000K051-023	9954-0081-6220	1396000K051-023
9507-9113-003	1396000K911-050	9954-0081-6227	1396000K911-040
9508-9113-002	1396000K921-024	9954-0081-6227	1396000K911-041
9576-9113-001	1396000K911-041	9954-0081-6229	1396000K911-049
		9954-0081-6229	1396000K911-050
		9954-0781-6215	1396000K051-020-EMI
		9954-0781-6215	1396000K051-021-EMI
		9954-0781-6217	1396000K911-038-EMI
		9954-0781-6217	1396000K911-039-EMI
		9954-0781-6219	1396000K911-047-EMI
		9954-0781-6219	1396000K911-048-EMI
		9954-0781-6220	1396000K051-022-EMI
		9954-0781-6220	1396000K051-023-EMI
		9954-0781-6227	1396000K911-040-EMI
		9954-0781-6227	1396000K911-041-EMI
		9954-0781-6229	1396000K911-049-EMI
		9954-0781-6229	1396000K911-050-EMI
Dynawave P/N	Delta P/N	M/A-COM P/N	Delta P/N
9852-0081-6214	1397000K911-016	2051-3350-02	1397000K051-016-EMI
9852-0081-6214	1397000K911-017	2051-3352-02	1397000K051-018-EMI
9852-0081-6215	1397000K921-022	2051-3354-02	1397000K921-022-EMI
9852-0081-6215	1397000K921-023	2051-3356-02	1397000K921-024-EMI
9852-0081-6220	1397000K921-024	2051-3362-02	1397000K051-019
9852-0081-6220	1397000K921-025	2051-3363-02	1397000K921-025
9852-0081-6224	1397000K911-018	2052-3350-02	1396000K051-020-EMI
9852-0081-6224	1397000K911-019	2052-3352-02	1396000K051-022-EMI
9852-0781-6214	1397000K911-016-EMI	2052-3354-02	1396000K921-021-EMI
9852-0781-6214	1397000K911-017-EMI	2052-3356-02	1396000K921-023-EMI
9852-0781-6215	1397000K921-022-EMI	2052-3362-02	1396000K051-023
9852-0781-6215	1397000K921-023-EMI	2052-3363-02	1396000K921-024
9852-0781-6220	1397000K921-024-EMI	2052-3375-02	1396000K911-040-EMI
9852-0781-6220	1397000K921-025-EMI	2052-3393-02	1396000K911-038-EMI
9852-0781-6224	1397000K911-018-EMI		
9852-0781-6224	1397000K911-019-EMI		
9854-0081-6215	1397000K051-016		
9854-0081-6215	1397000K051-017		
9854-0081-6217	1397000K911-025		
9854-0081-6217	1397000K911-026		
9854-0081-6220	1397000K051-018		
9854-0081-6227	1397000K911-027		
9854-0081-6227	1397000K911-028		
9854-0781-6215	1397000K051-016-EMI		
9854-0781-6215	1397000K051-017-EMI		
9854-0781-6217	1397000K911-025-EMI		
9854-0781-6217	1397000K911-026-EMI		

Competitive Cross Reference - 26.5-GHz SMA Connectors

M/A-COM P/N	Delta P/N	Tensolite (CDI) P/N	Delta P/N
2052-3399-02	1396000K911-034-EMI	4004-5	41-10038-01-AU
2052-3400-02	1396000K911-036-EMI	4004-9	41-10039-01-AU
2052-3500-02	1396000K051-021-EMI	4004-11	41-10040-01-AU
2052-3501-02	1396000K911-039-EMI	4004-13	41-10041-01-AU
2052-3502-02	1396000K921-022-EMI	5601-1CCSF	1396000K911-033-EMI
2052-3503-02	1396000K911-035-EMI	5601-2CCSF	1396000K911-032-EMI
2098-3520-94	41-10038-01-AU	5601-4CCSF	1396000K911-029-EMI
2098-3251-94	41-10040-01-AU	5601-5CCSF	1396000K911-030-EMI
2098-3441-94	41-10039-01-AU	5601-6CCSF	1396000K911-031-EMI
		5602-2CCSF	1396000K921-024-EMI
		5602-4CCSF	1396000K921-021-EMI
		5602-5CCSF	1396000K921-022-EMI
		5602-6CCSF	1396000K921-023-EMI
		5603-2CCSF	1396000K911-041-EMI
		5603-4CCSF	1396000K911-038-EMI
		5603-5CCSF	1396000K911-039-EMI
		5603-6CCSF	1396000K911-040-EMI
		5604-2CCSF	1396000K051-023-EMI
		5604-4CCSF	1396000K051-020-EMI
		5604-5CCSF	1396000K051-021-EMI
		5604-6CCSF	1396000K051-022-EMI
		5605-2CCSF	1396000K911-050-EMI
		5605-4CCSF	1396000K911-047-EMI
		5605-5CCSF	1396000K911-048-EMI
		5605-6CCSF	1396000K911-049-EMI
		5606-2CCSF	1397000K921-025-EMI
		5606-4CCSF	1397000K921-022-EMI
		5606-5CCSF	1397000K921-023-EMI
		5606-6CCSF	1397000K921-024-EMI
		5607-2CCSF	1397000K911-028-EMI
		5607-4CCSF	1397000K911-025-EMI
		5607-5CCSF	1397000K911-026-EMI
		5607-6CCSF	1397000K911-027-EMI
		5608-2CCSF	1397000K051-019-EMI
		5608-4CCSF	1397000K051-016-EMI
		5608-5CCSF	1397000K051-017-EMI
		5608-6CCSF	1397000K051-018-EMI
		5609-2CCSF	1397000K911-037-EMI
		5609-4CCSF	1397000K911-034-EMI
		5609-5CCSF	1397000K911-035-EMI
		5609-6CCSF	1397000K911-036-EMI
		5633-1CCSF	1397000K911-015-EMI
		5633-2CCSF	1397000K911-014-EMI
		5633-4CCSF	1397000K911-011-EMI
		5633-5CCSF	1397000K911-012-EMI
		5633-6CCSF	1397000K911-013-EMI
		5634-2CCSF	1396000K911-037-EMI
		5634-4CCSF	1396000K911-034-EMI
		5634-5CCSF	1396000K911-035-EMI
		5634-6CCSF	1396000K911-036-EMI
		5635-2CCSF	1397000K911-019-EMI
		5635-4CCSF	1397000K911-016-EMI
		5635-5CCSF	1397000K911-017-EMI
		5635-6CCSF	1397000K911-018-EMI
		5663-2CCSF	1396000K921-024
		5663-4CCSF	1396000K921-021
		5663-5CCSF	1396000K921-022
		5663-6CCSF	1396000K921-023
		5664-2CCSF	1397000K921-025
		5664-4CCSF	1397000K921-022
		5664-5CCSF	1397000K921-023
		5664-6CCSF	1397000K921-024
		5665-2CCSF	1396000K051-023
		5665-4CCSF	1396000K051-020
		5665-5CCSF	1396000K051-021
		5665-6CCSF	1396000K051-022

Competitive Cross Reference - 26.5-GHz SMA Connectors

Tensolite (CDI) P/N	Delta P/N	Tensolite (CDI) P/N	Delta P/N
5666-2CCSF	1397000K051-019	5715-2CCSF	1396000K911-045-EMI
5666-4CCSF	1397000K051-016	5715-4CCSF	1396000K911-042-EMI
5666-5CCSF	1397000K051-017	5715-5CCSF	1396000K911-043-EMI
5666-6CCSF	1397000K051-018	5715-6CCSF	1396000K911-044-EMI
5668-2CCSF	1396000K911-050	5716-1CCSF	1397000K911-033-EMI
5668-4CCSF	1396000K911-047	5716-2CCSF	1397000K911-032-EMI
5668-5CCSF	1396000K911-048	5716-4CCSF	1397000K911-029-EMI
5668-6CCSF	1396000K911-049	5716-5CCSF	1397000K911-030-EMI
5669-2CCSF	1397000K911-037	5716-6CCSF	1397000K911-031-EMI
5669-4CCSF	1397000K911-034	5717-1CCSF	1396000K911-046
5669-5CCSF	1397000K911-035	5717-2CCSF	1396000K911-045
5669-6CCSF	1397000K911-036	5717-4CCSF	1396000K911-042
5674-1CCSF	1396000K911-033	5717-5CCSF	1396000K911-043
5674-2CCSF	1396000K911-032	5717-6CCSF	1396000K911-044
5674-4CCSF	1396000K911-029	5718-1CCSF	1397000K911-033
5674-5CCSF	1396000K911-030	5718-2CCSF	1397000K911-032
5674-6CCSF	1396000K911-031	5718-4CCSF	1397000K911-029
5675-1CCSF	1397000K911-015	5718-5CCSF	1397000K911-030
5675-2CCSF	1397000K911-014	5718-6CCSF	1397000K911-031
5675-4CCSF	1397000K911-011	5780-1CCSF	1397000K051-015
5675-5CCSF	1397000K911-012	5780-2CCSF	1397000K051-014
5675-6CCSF	1397000K911-013	5780-4CCSF	1397000K051-011
5678-2CCSF	1396000K911-037	5780-5CCSF	1397000K051-012
5678-4CCSF	1396000K911-034	5780-6CCSF	1397000K051-013
5678-5CCSF	1396000K911-035	5923-1CCSF	1396000K911-027
5678-6CCSF	1396000K911-036	5923-2CCSF	1396000K911-026
5679-2CCSF	1397000K911-019	5923-4CCSF	1396000K911-023
5679-4CCSF	1397000K911-016	5923-5CCSF	1396000K911-024
5679-5CCSF	1397000K911-017	5923-6CCSF	1396000K911-025
5679-6CCSF	1397000K911-018	5925-1CCSF	1397000K911-024
5680-1CCSF	1396000K051-019	5925-2CCSF	1397000K911-023
5680-2CCSF	1396000K051-018	5925-4CCSF	1397000K911-020
5680-4CCSF	1396000K051-015	5925-5CCSF	1397000K911-021
5680-5CCSF	1396000K051-016	5925-6CCSF	1397000K911-022
5680-6CCSF	1396000K051-017	5935-1CCSF	1396000K911-027-EMI
5681-1CCSF	1396000K921-029	5935-2CCSF	1396000K911-026-EMI
5681-2CCSF	1396000K921-028	5935-4CCSF	1396000K911-023-EMI
5681-4CCSF	1396000K921-025	5935-5CCSF	1396000K911-024-EMI
5681-5CCSF	1396000K921-026	5935-6CCSF	1396000K911-025-EMI
5681-6CCSF	1396000K921-027	5936-1CCSF	1397000K911-024-EMI
5683-1CCSF	1397000K921-021	5936-2CCSF	1397000K911-023-EMI
5683-2CCSF	1397000K921-020	5936-4CCSF	1397000K911-020-EMI
5683-4CCSF	1397000K921-017	5936-5CCSF	1397000K911-021-EMI
5683-5CCSF	1397000K921-018	5936-6CCSF	1397000K911-022-EMI
5683-6CCSF	1397000K921-019	5941-2CCSF	1396000K911-041
5684-1CCSF	1396000K051-019-EMI	5941-4CCSF	1396000K911-038
5684-2CCSF	1396000K051-018-EMI	5941-5CCSF	1396000K911-039
5684-4CCSF	1396000K051-015-EMI	5941-6CCSF	1396000K911-040
5684-5CCSF	1396000K051-016-EMI	5942-2CCSF	1397000K911-028
5684-6CCSF	1396000K051-017-EMI	5942-4CCSF	1397000K911-025
5685-1CCSF	1396000K921-029-EMI	5942-5CCSF	1397000K911-026
5685-2CCSF	1396000K921-028-EMI	5942-6CCSF	1397000K911-027
5685-4CCSF	1396000K921-025-EMI		
5685-5CCSF	1396000K921-026-EMI		
5685-6CCSF	1396000K921-027-EMI		
5686-1CCSF	1397000K051-015-EMI		
5686-2CCSF	1397000K051-014-EMI		
5686-4CCSF	1397000K051-011-EMI		
5686-5CCSF	1397000K051-012-EMI		
5686-6CCSF	1397000K051-013-EMI		
5687-1CCSF	1397000K921-021-EMI		
5687-2CCSF	1397000K921-020-EMI		
5687-4CCSF	1397000K921-017-EMI		
5687-5CCSF	1397000K921-018-EMI		
5687-6CCSF	1397000K921-019-EMI		
5715-1CCSF	1396000K911-046-EMI		

Competitive Cross-Reference—27.0 GHz SMA Connectors

Please note that these connectors are *functional equivalents* to the competitor part numbers shown. If you are using a competitor's connector in a critical application, please contact us for engineering assistance and samples to determine the compatibility of our connectors with your application.

Southwest P/N	Delta P/N	Southwest P/N	Delta P/N
211-500SF	1397000K051-006	214-517SF	1396000K911-053
211-501SF	1397000K051-007	214-518SF	1396000K911-057
211-502SF	1397000K051-009	214-520SF	1396000K911-055
211-503SF	1397000K051-010	214-521SF	1396000K911-056
211-504SF	1397000K051-008	214-522SF	1396000K911-058
211-505SF	1397000K911-003	214-537SF	1396000K921-031
211-510SF	1397000K911-001	214-538SF	1396000K911-073
211-511SF	1397000K911-002	214-539SF	1396000K911-074
211-512SF	1397000K911-004	220-500SF	1396000K821-005
211-513SF	1397000K911-005	220-501SF	1396000K821-006
211-514SF	1397000K911-006	220-502SF	1396000K821-008
211-515SF	1397000K911-007	220-503SF	1396000K821-009
211-516SF	1397000K911-008	220-506SF	1396000K821-007
211-517SF	1397000K911-009	220-507SF	1396000K821-022
211-518SF	1397000K911-010	221-500SF	1397000K821-001
211-523SF	1397000K911-065	221-501SF	1397000K821-002
211-524SF	1397000K051-024	221-502SF	1397000K821-004
211-525SF	1397000K911-066	221-503SF	1397000K821-005
212-500SF	1396000K051-006	221-504SF	1397000K821-003
212-501SF	1396000K051-007	221-505SF	1397000K821-006
212-502SF	1396000K051-009	230-506SF	1334000K001-901
212-503SF	1396000K051-010	231-502SF	1327000K001-901
212-505SF	1396000K911-006	232-502SF	1328000K001-902
212-506SF	1396000K051-008	232-510SF	1326000K671-900
212-507SF	1396000K911-003	290-00G	41-10046-01-AU
212-508SF	1396000K911-008	290-01G	41-10047-01-AU
212-510SF	1396000K911-001	290-02G	41-10048-01-AU
212-511SF	1396000K911-002	290-06G	41-10045-01-AU
212-512SF	1396000K911-004	290-07G	41-10049-01-AU
212-513SF	1396000K911-005	290-09G	33-10416-01-AU
212-530SF	1396000K911-010	290-10G	81-10260-01-AU
212-531SF	1396000K911-007	290-33G	81-10275-01-AU
212-532SF	1396000K911-075	1090-05G	33-10432-01-AU
212-536SF	1396000K911-009	1490-01G	81-10293-01-AU
212-550SF	1396000K051-024		
212-551SF	1396000K911-076		
213-500SF	1397000K921-011		
213-501SF	1397000K921-012		
213-502SF	1397000K921-014		
213-503SF	1397000K921-015		
213-504SF	1397000K921-013		
213-505SF	1397000K911-040		
213-510SF	1397000K911-038		
213-511SF	1397000K911-039		
213-512SF	1397000K911-041		
213-516SF	1397000K911-044		
213-517SF	1397000K921-030		
213-518SF	1397000K911-063		
213-519SF	1397000K911-064		
213-520SF	1397000K911-042		
213-521SF	1397000K911-043		
213-522SF	1397000K911-045		
214-500SF	1396000K921-011		
214-501SF	1396000K921-012		
214-502SF	1396000K921-014		
214-503SF	1396000K921-015		
214-510SF	1396000K911-051		
214-511SF	1396000K911-052		
214-512SF	1396000K911-054		
214-516SF	1396000K921-013		

Index by Delta Part Number

Click on any line to go to the target page.

Delta P/N	Page	Delta P/N	Page	Delta P/N	Page
33-10415-01-AU	15	1396000K051-015	7	1396000K911-036	9
33-10416-01-AU	15, 25	1396000K051-015-EMI	8	1396000K911-036-EMI	10
33-10417-01-AU	15	1396000K051-016	7	1396000K911-037	9
33-10418-01-AU	15	1396000K051-016-EMI	8	1396000K911-037-EMI	10
33-10432-01-AU	15, 25	1396000K051-017	7	1396000K911-038	9
41-10038-01-AU	16	1396000K051-017-EMI	8	1396000K911-038-EMI	10
41-10039-01-AU	16	1396000K051-018	7	1396000K911-039	9
41-10040-01-AU	16	1396000K051-018-EMI	8	1396000K911-039-EMI	10
41-10041-01-AU	16	1396000K051-019	7	1396000K911-040	9
41-10042-01-AU	16	1396000K051-019-EMI	8	1396000K911-040-EMI	10
41-10044-01-AU	25	1396000K051-020	9	1396000K911-041	9
41-10045-01-AU	25	1396000K051-020-EMI	10	1396000K911-041-EMI	10
41-10046-01-AU	25	1396000K051-021	9	1396000K911-042	7
41-10047-01-AU	25	1396000K051-021-EMI	10	1396000K911-042-EMI	8
41-10048-01-AU	25	1396000K051-022	9	1396000K911-043	7
41-10049-01-AU	25	1396000K051-022-EMI	10	1396000K911-043-EMI	8
41-10050-01-AU	25	1396000K051-023	9	1396000K911-044	7
41-10051-01-AU	25	1396000K051-023-EMI	10	1396000K911-044-EMI	8
53-10025-02-NP	16	1396000K051-024	19	1396000K911-045	7
53-10025-03-NP	16	1396000K821-001	23	1396000K911-045-EMI	8
81-10260-01-AU	25	1396000K821-002	23	1396000K911-046	7
81-10275-01-AU	25	1396000K821-003	23	1396000K911-046-EMI	8
81-10293-01-AU	25	1396000K821-004	23	1396000K911-047	9
81-10294-01-AU	25	1396000K821-005	23	1396000K911-047-EMI	10
1301025K003-900	5	1396000K821-006	23	1396000K911-048	9
1301031K003-900	5	1396000K821-007	23	1396000K911-048-EMI	10
1308025G003-900	5	1396000K821-008	23	1396000K911-049	9
1308031G003-900	5	1396000K821-009	23	1396000K911-049-EMI	10
1317025G673-900	5	1396000K821-022	23	1396000K911-050	9
1317031G673-900	5	1396000K911-001	19	1396000K911-050-EMI	10
1321000G821-900	15	1396000K911-002	19	1396000K911-051	20
1321000G821-901	15	1396000K911-003	19	1396000K911-052	20
1321000K821-128	23	1396000K911-004	19	1396000K911-053	20
1321000K821-129	23	1396000K911-005	19	1396000K911-054	20
1321000K821-900	15	1396000K911-006	19	1396000K911-055	20
1321000K821-901	15	1396000K911-007	19	1396000K911-056	20
1326000K671-900	24	1396000K911-008	19	1396000K911-057	20
1327000G001-900	15	1396000K911-009	19	1396000K911-058	20
1327000K001-900	15	1396000K911-010	19	1396000K911-073	20
1327000K001-901	24	1396000K911-023	7	1396000K911-074	20
1328000G001-900	15	1396000K911-023-EMI	8	1396000K911-075	19
1328000K001-900	15	1396000K911-024	7	1396000K911-076	19
1328000K001-902	24	1396000K911-024-EMI	8	1396000K921-011	20
1334000G001-900	15	1396000K911-025	7	1396000K921-012	20
1334000K001-900	15	1396000K911-025-EMI	8	1396000K921-013	20
1334000K001-901	24	1396000K911-026	7	1396000K921-014	20
1358000G051-900	6	1396000K911-026-EMI	8	1396000K921-015	20
1358000G911-900	6	1396000K911-027	7	1396000K921-021	9
1358000G921-900	6	1396000K911-027-EMI	8	1396000K921-021-EMI	10
1358000K051-900	6	1396000K911-029	7	1396000K921-022	9
1358000K911-900	6	1396000K911-029-EMI	8	1396000K921-022-EMI	10
1358000K921-900	6	1396000K911-030	7	1396000K921-023	9
1359000G051-900	6	1396000K911-030-EMI	8	1396000K921-023-EMI	10
1359000G911-900	6	1396000K911-031	7	1396000K921-024	9
1359000G921-900	6	1396000K911-031-EMI	8	1396000K921-024-EMI	10
1359000K051-900	6	1396000K911-032	7	1396000K921-025	7
1359000K911-900	6	1396000K911-032-EMI	8	1396000K921-025-EMI	8
1359000K921-900	6	1396000K911-033	7	1396000K921-026	7
1396000K051-006	19	1396000K911-033-EMI	8	1396000K921-026-EMI	8
1396000K051-007	19	1396000K911-034	9	1396000K921-027	7
1396000K051-008	19	1396000K911-034-EMI	10	1396000K921-027-EMI	8
1396000K051-009	19	1396000K911-035	9	1396000K921-028	7
1396000K051-010	19	1396000K911-035-EMI	10	1396000K921-028-EMI	8

Index by Delta Part Number

Click on any line to go to the target page.

Delta P/N	Page	Delta P/N	Page	Delta P/N	Page
1396000K921-029	7	1397000K911-021	11	1397000K921-023	13
1396000K921-029-EMI	8	1397000K911-021-EMI	12	1397000K921-023-EMI	14
1396000K921-031	20	1397000K911-022	11	1397000K921-024	13
1397000K051-006	21	1397000K911-022-EMI	12	1397000K921-024-EMI	14
1397000K051-007	21	1397000K911-023	11	1397000K921-025	13
1397000K051-008	21	1397000K911-023-EMI	12	1397000K921-025-EMI	14
1397000K051-009	21	1397000K911-024	11	1397000K921-030	22
1397000K051-010	21	1397000K911-024-EMI	12		
1397000K051-011	11	1397000K911-025	11		
1397000K051-011-EMI	12	1397000K911-025-EMI	14		
1397000K051-012	11	1397000K911-026	13		
1397000K051-012-EMI	12	1397000K911-026-EMI	14		
1397000K051-013	11	1397000K911-027	13		
1397000K051-013-EMI	12	1397000K911-027-EMI	14		
1397000K051-014	11	1397000K911-028	13		
1397000K051-014-EMI	12	1397000K911-028-EMI	14		
1397000K051-015	11	1397000K911-029	11		
1397000K051-015-EMI	12	1397000K911-029-EMI	12		
1397000K051-016	11	1397000K911-030	11		
1397000K051-016-EMI	14	1397000K911-030-EMI	12		
1397000K051-017	13	1397000K911-031	11		
1397000K051-017-EMI	14	1397000K911-031-EMI	12		
1397000K051-018	13	1397000K911-032	11		
1397000K051-018-EMI	14	1397000K911-032-EMI	12		
1397000K051-019	13	1397000K911-033	11		
1397000K051-019-EMI	14	1397000K911-033-EMI	12		
1397000K051-024	21	1397000K911-034	13		
1397000K821-001	23	1397000K911-034-EMI	14		
1397000K821-002	23	1397000K911-035	13		
1397000K821-003	23	1397000K911-035-EMI	14		
1397000K821-004	23	1397000K911-036	13		
1397000K821-005	23	1397000K911-036-EMI	14		
1397000K821-006	23	1397000K911-037	13		
1397000K911-001	21	1397000K911-037-EMI	14		
1397000K911-002	21	1397000K911-038	22		
1397000K911-003	21	1397000K911-039	22		
1397000K911-004	21	1397000K911-040	22		
1397000K911-005	21	1397000K911-041	22		
1397000K911-006	21	1397000K911-042	22		
1397000K911-007	21	1397000K911-043	22		
1397000K911-008	21	1397000K911-044	22		
1397000K911-009	21	1397000K911-045	22		
1397000K911-010	21	1397000K911-063	22		
1397000K911-011	11	1397000K911-064	22		
1397000K911-011-EMI	12	1397000K911-065	21		
1397000K911-012	11	1397000K911-066	21		
1397000K911-012-EMI	12	1397000K921-011	22		
1397000K911-013	11	1397000K921-012	22		
1397000K911-013-EMI	12	1397000K921-013	22		
1397000K911-014	11	1397000K921-014	22		
1397000K911-014-EMI	12	1397000K921-015	22		
1397000K911-015	11	1397000K921-017	11		
1397000K911-015-EMI	12	1397000K921-017-EMI	12		
1397000K911-016	13	1397000K921-018	11		
1397000K911-016-EMI	14	1397000K921-018-EMI	12		
1397000K911-017	13	1397000K921-019	11		
1397000K911-017-EMI	14	1397000K921-019-EMI	12		
1397000K911-018	13	1397000K921-020	11		
1397000K911-018-EMI	14	1397000K921-020-EMI	12		
1397000K911-019	13	1397000K921-021	11		
1397000K911-019-EMI	14	1397000K921-021-EMI	12		
1397000K911-020	11	1397000K921-022	13		
1397000K911-020-EMI	12	1397000K921-022-EMI	14		



CREATE

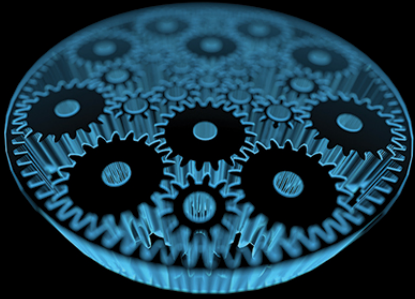

COLLABORATE

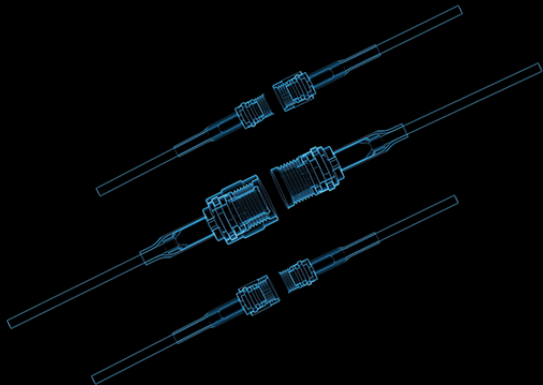

CONNECT



Delta Electronics Mfg. Corp.

www.deltarf.com
978-927-1060
sales@deltarf.com

PO Box 53
416 Cabot St.
Beverly, MA 01915

