



RF & Microwave Connectors Volume 9



Create

Collaborate

Connect



Here is a listing of our other catalogs. Click on a catalog to open.



Fidelity⁺



VITA 67



Gang Mounts

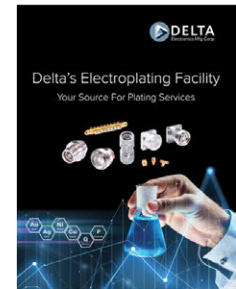

Plating



Capabilities



MCX & MMCX



MHF / U.FL



SSMC



Mil-Spec



4.1 / 9.5



SMK

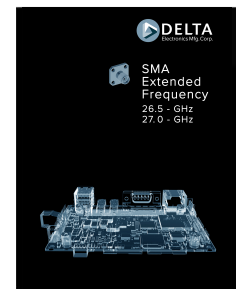

SMA 26.5 & 27.0



SMP & SMPM

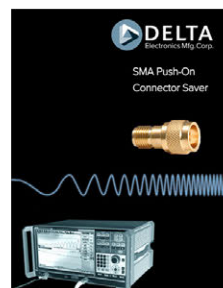

Connector Saver

We have configured this online version of our catalog to take advantage of Acrobat navigation shortcuts (links). However, these links are not visible on the pages— making them visible would compromise the page’s readability.

- Clicking on any entry in the main Table of Contents (or the configuration listings on the first page of each series section) will take you to the indicated page.
- Clicking on a part number in the Index will take you directly to the indicated page. (You may also use Acrobat’s “find” command to enter a Delta part number and go directly to the page).
- Shown below are the “hot spots” on all of the product pages that will take you to background information on various connector characteristics.
- When using a “hot spot” to jump to another page, you can utilize the “back” arrow in Acrobat’s menu bar to return to the page you jumped.
- You can also utilize the Acrobat bookmarks and thumbnails to navigate by configuring your copy of Acrobat Reader to show bookmarks or thumbnails.

In addition, the pages have been reformatted to fit within the margins of standard laser or inkjet printers—no need to use the “shrink to fit” option when printing pages from Acrobat.

Click [here](#) to go to the Table of Contents

Click [here](#) to go to the Index by Part Number

Click on the Delta logo on any page to jump to this navigation guide.

Click on the page title to jump to the introductory page with specifications and configuration listings for the connector series.



BNC Cable Jacks

Panel Jack - Military Clamp for Flexible Cable

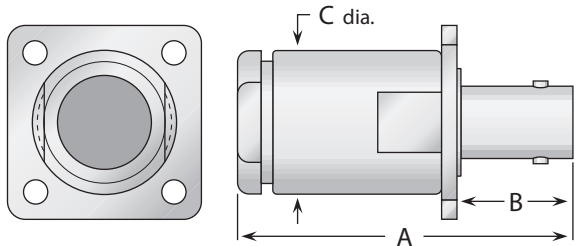

Figure 1

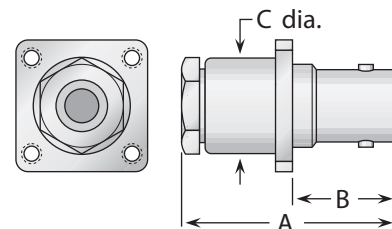

Figure 2

Cable Group	Fig.	Dimensions			Mounting Figure	Plating		Delta P/N	Assembly Procedure/ Trim Code
		A	B	C		Body	Contact		
1	1	1.75	.63	.75	33	Nickel	Silver	1011-001-N330	A/20
2, 3	1	1.75	.63	.75	33	Nickel	Silver	1011-004-N330	A/20
5, 6	2	1.16	.55	.50	07	Nickel	Silver	UG-291C/U	A/17

Click here to jump to dimensions for Delta mounting figures.

Click here to jump to the cable assembly procedure for this connector.

Click here to jump to a guide to Delta cable groups.

Connector Series Size Comparison Chart

All of our product lines shown at actual size. 4

Design Features

Examples of how our Customer-Driven Design can help you build your products more efficiently, quickly, and cost-effectively. 6

BMA series

Subminiature, high-frequency connectors with slide-on mating. 11

BNC series

Miniature, economical connectors with bayonet-type mating. 12

75 Ω BNC series

For matched-impedance applications. 31

C series

Medium-size connectors with bayonet-type mating and good power handling. 34

G874 series

Hermaphroditic connectors with good electrical performance; ideal for test equipment. 40

GHV series

Large, high-voltage connectors, threaded. 44

HN series

Medium-size connectors with threaded mating and good power handling. 45

LC/LT series

Large, high-voltage connectors, threaded. 51

MCX series

Connectors with snap-on mating, 30% smaller than SMB connectors. 54

MHV series

Miniature, high-voltage connectors with bayonet mating (similar to BNC). 59

MMCX series

Microminiature connectors with snap-on mating and low RF leakage. 63

MQD (Miniature QDS) series

Miniature connectors with positive-locking, quick-connect and disconnect mating. 66

N series

Medium-size, versatile, general-purpose connectors with threaded mating. 67

70 Ω N series

For matched-impedance applications. 89

QDS series

Medium-size connectors with positive-locking, quick-connect and disconnect mating. 92

QMA series

Subminiature, SMA-size connectors with slide-on mating and brass bodies. 97

SC series

Medium-size connectors with threaded mating and good power handling. 98

SMA series

Subminiature, high-frequency connectors with threaded mating and stainless steel bodies. 102

E-Line Brass SMA series

Economical brass-body SMA connectors, ideal for use in commercial applications. 123

SMB and SMC series

Subminiature, economical connectors with snap-on or threaded mating. 130

TNC series

Miniature connectors, similar in size to BNC, with threaded mating. 136

Polarized TNC series

Meet FCC regulations. 152

TPS series

Subminiature, connectors with triple-bayonet mating to prevent rocking when mated. 153

TRB series

Triaxial version of BNC connectors. 156

TW34 series

Medium-size connectors with threaded mating for twinaxial cables. 158

TWBNC series

Twinaxial version of BNC connectors. 161

UHF series

Low-frequency connectors, threaded mating. 163

1.0/2.3 series

Subminiature DIN connectors with slide-on, snap-on, or locking mating. 164

7/16 series

Medium-size, versatile connectors with metric threaded coupling and good power handling. 166

Between-Series Adapters. 176
MILQualified Products

MIL-PRF-39012 QPL connectors, and MIL-PRF-55339 QPL adapters. 186

Mounting Figures. 208
Cable Groups. 209
Cable Assembly Instructions. 210
Index by Part Number. 217
Customized Solutions

Unique designs solve difficult problems. 230

Technical Information

Guide to connector configurations and terminology. 231

About Delta. 233
Ordering and Warranty. 236

Connector Size Comparison (All shown actual size)

Size categories (subminiature, miniature, etc.) are common usage, but are not industry standards.

Diameters are for reference, and may vary slightly within each series with connector configuration.

Microminiature Connectors

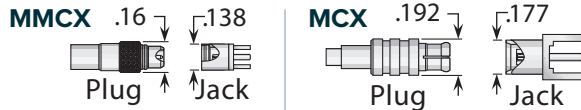

Subminiature Connectors

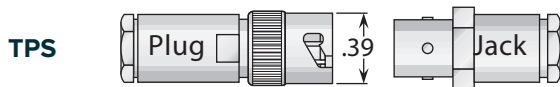
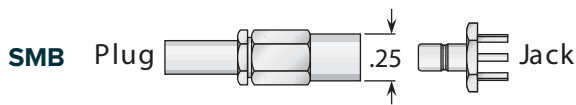
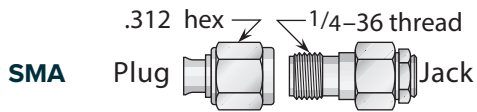

Miniature Connectors

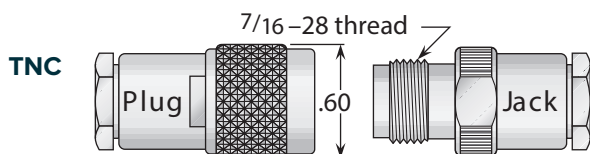
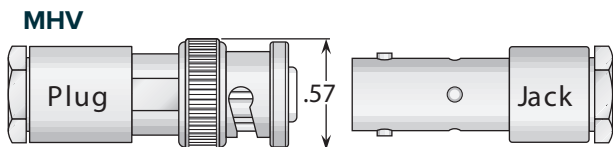
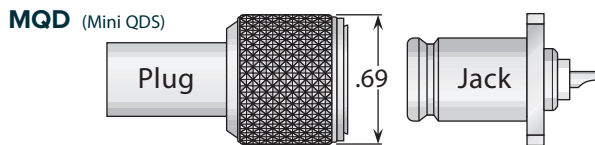
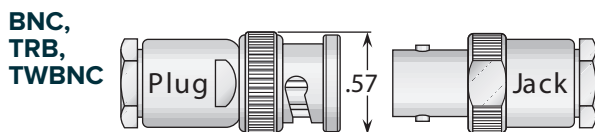

Medium Connectors

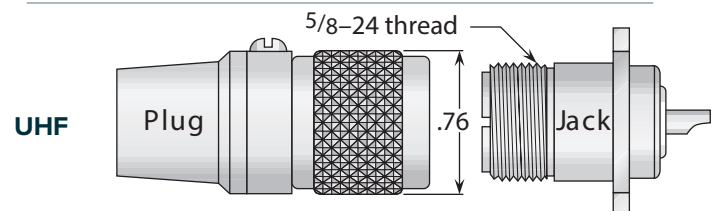
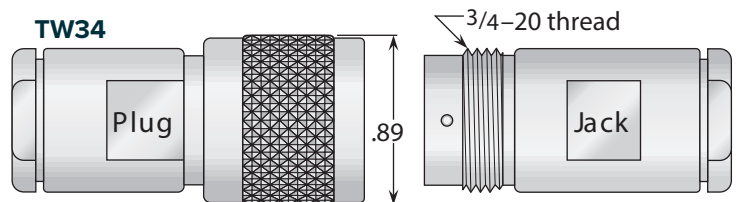
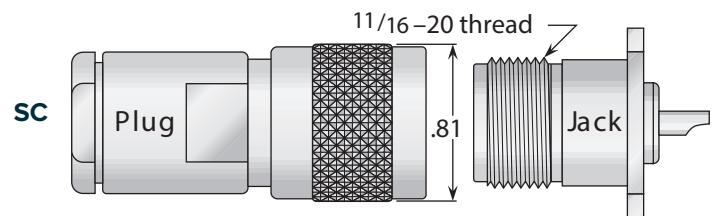
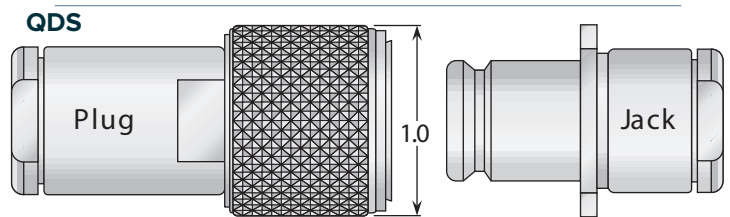
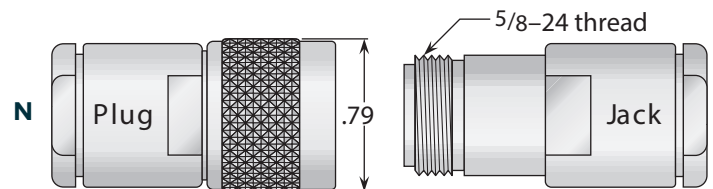
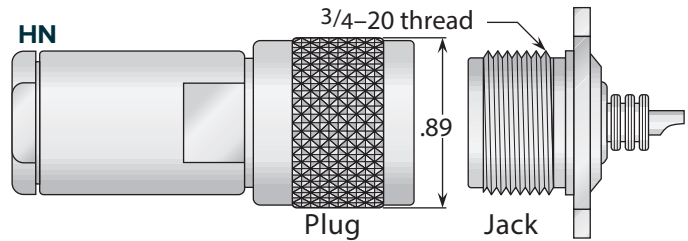
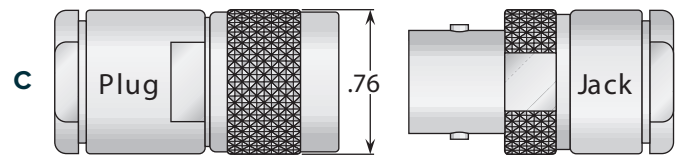

More on next page

Connector Size Comparison (All shown actual size)

Size categories (subminiature, miniature, etc.) are common usage, but are not industry standards.
 Diameters are for reference, and may vary slightly within each series with connector configuration.

Large Connectors

7/16

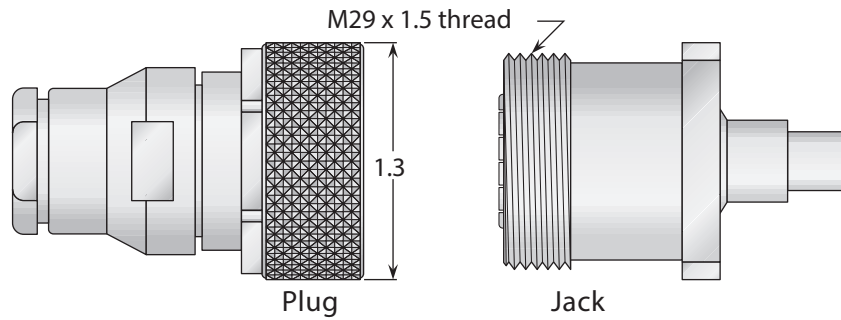

G874

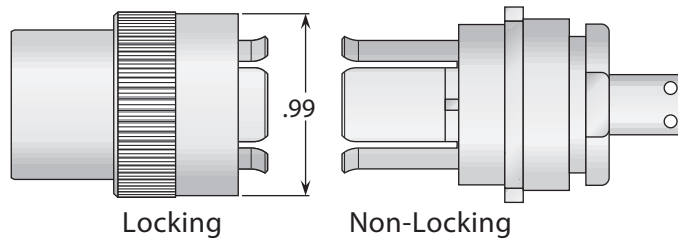

GHV

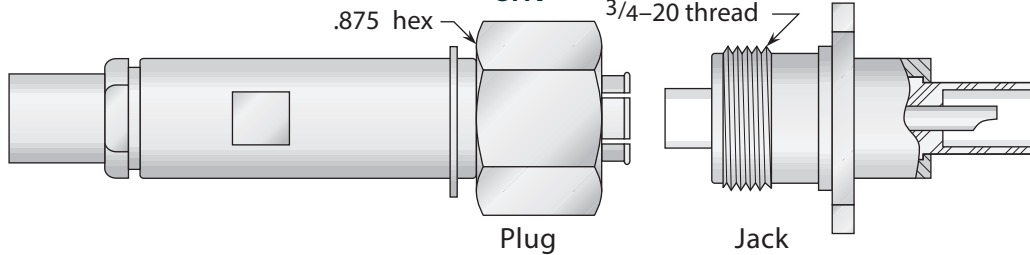

LCandLT

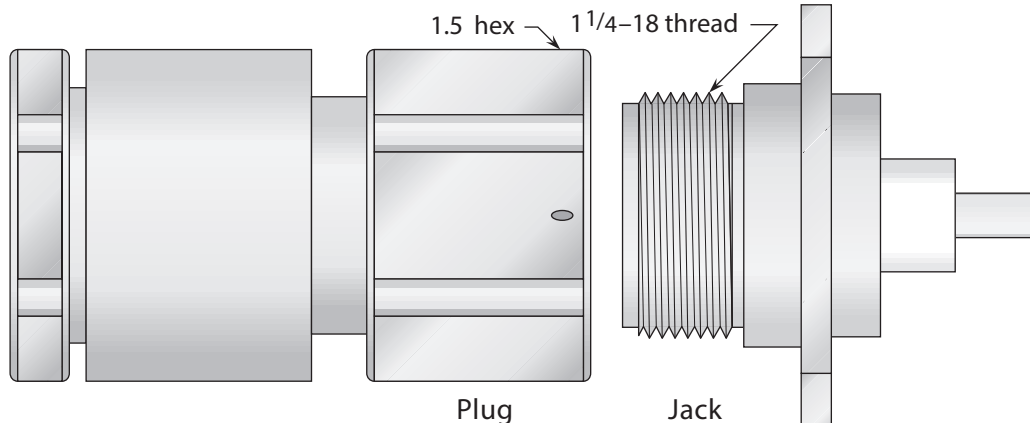

About Delta's Customer-Driven Design

At Delta, Customer-Driven Design isn't just a catchy slogan. It means that we make RF connectors that help you build your products efficiently, quickly, and cost-effectively. Because we design for your needs, nobody else can offer you such a broad line of standard connectors, along with an ever-growing list of innovative, user-friendly design variations like those detailed on these pages.

These featured connector technologies grew out of real-world requirements, and have saved our customers untold hours and dollars over the years. And there are thousands of other special connector designs we've produced that we don't have space to include in this catalog (see the inside back cover for some examples).

So if you don't see the exact connector configuration you need, please call us—we may have already made it. If not, we'll work with you to provide the connectors you need, with the best price/performance balance in the business, and with quality and delivery that will enhance your products and production schedules.

Plating Options for Economy and Performance

(Albaloy or nickel—available for all connector series)

Silver plating has long been standard on RF connectors, but its high cost and low corrosion resistance make it less than ideal in most applications. Nickel plating is less expensive and more durable than silver, and is standard on many of our connectors.

However, in some applications, nickel plating can introduce unwanted intermodulation distortion, particularly on large size connectors. For these applications, we offer optional Albaloy plating, a tin/zinc/copper composite with a bright white finish, the corrosion resistance of nickel, and the low intermodulation distortion of silver plating.

Albaloy plating has the same composition as, and is fully compatible with, other commercial platings designated Sucoplate[®], IP-23, White Bronze, and Tri-Alloy.

To order a Delta connector with plating other than the listed finish, substitute A, N, or Q in the Delta part number as below:

For silver plating: 1111111A 111-111. • For nickel plating: 1111111N 111-111. • For Albaloy plating: 1111111Q 111-111.

Note: M39012 and M55339 QPL connectors can only be supplied with the specified plating.

N Panel Receptacles With One-Piece Bodies

(Available for most type N 4-hole flange receptacles—contact factory for exact types)



Our in-house machining capability now includes production of type N flange receptacles with one-piece bodies, replacing the old machined body/stamped flange method. With no unsightly solder joints, these connectors have enhanced appearance and strength compared with two-piece designs. The machined flanges are flatter than stamped flanges as well, and our high-speed turning centers can produce any volume required to fill your production quantity needs.

Polarized TNC Connectors Prevent Mismatching

(See page 152 for standard types)

FCC Part 15.203 requirements mandate the use of a nonstandard interface in spread-spectrum wireless applications, and further specify that the connectors must not be damaged when an attempt is made to mate them with standard connectors. Delta's polarized TNC plugs and jack meet these requirements without the additional expense of other designs, such as connectors with left-hand threads.



For systems that need more than two polarizations to prevent mismatching of connector pairs, see our unique line of keying baskets and keyed plugs on page 149.

SMA connector pairs can also be provided with reverse polarity - call for availability.

Common Flange Sizes Simplify Your Production

(Available on BNC, N, SMA, TNC, and 7/16 series connectors as noted in product pages)

Does it make sense that you have to drill your components with different mounting hole patterns whenever you need to ship them with a different connector series attached? We didn't think so, either. That's why we offer a wide range of connectors in different series with common flange sizes and contact/insulator configurations. Now you can streamline your production process and shorten your delivery cycle—just predrill your components with one mounting hole pattern, and ship them with the connectors your customers require.

Flange Sizes and Available Interfaces

1/2" square flange (Delta mounting figure 05)—standard flange size for SMA

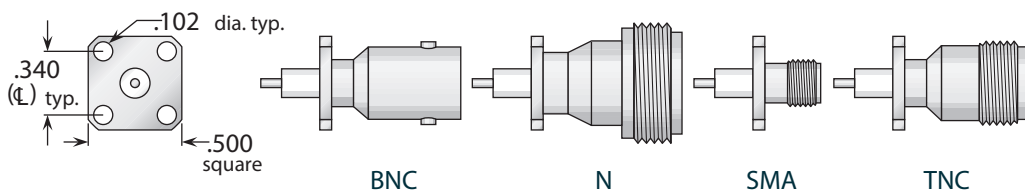

11/16" square flange (Delta mounting figure 09)—standard flange size for BNC, TNC

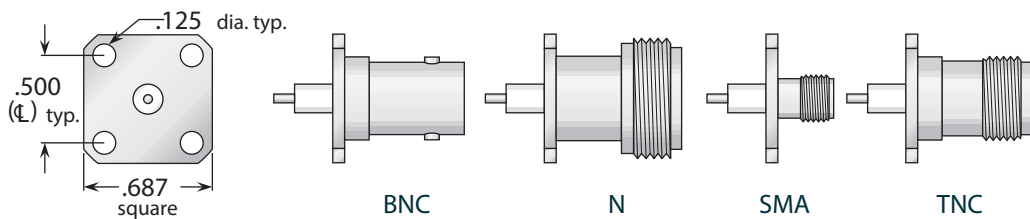

1" square flange (Delta mounting figure 33)—standard flange size for type N

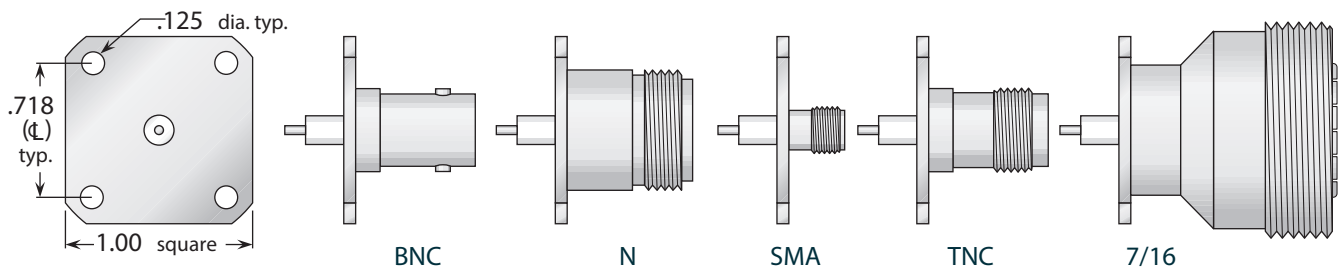

Contact and insulator configurations are shown for illustration only—these connectors are available with a wide variety of post, tab, solder pot, or slotted contacts.

Standard configurations are shown on product pages, and your request for a custom design is always welcome.

Delta Press Mount Receptacles

Available for BNC, N, and TNC connector series as noted in product pages.



Delta PressMount receptacles eliminate the need for complicated mounting hole patterns and mounting hardware. They are simply pressed into a single through hole, and can be used in component housings as small as the outer diameter of the connector. An integral shoulder provides a positive depth stop during mounting.

Besides the standard types shown below and in the product pages, PressMount receptacles are available with a wide variety of contact and insulator configurations—please call if you don't see what you need.

Standard Press Mount Receptacles

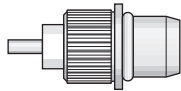

BMA plug (page 11)

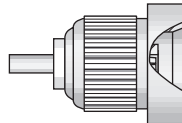

MCX jack (page 58)

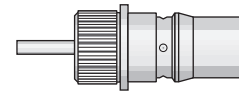

QMA jack (page 97)

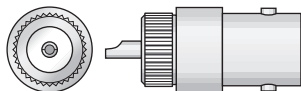

BNC jack (page 27)

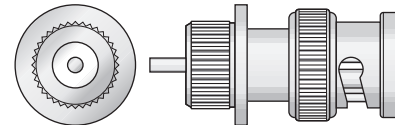

BNC plug (page 27)

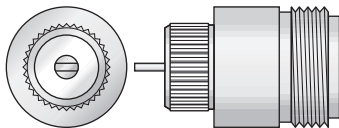

N jack (page 85)

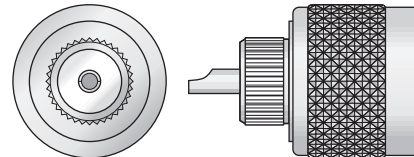

N plug (page 85)

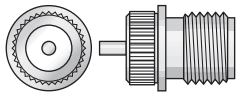

SMA jack (page 115)

SMA plug (page 115)

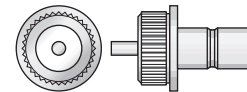
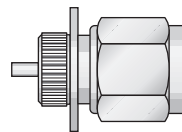

SMB jack (page 133)

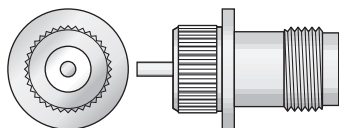

TNC jack (page 147)

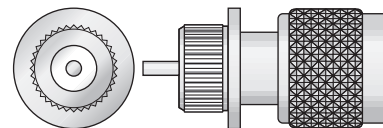

TNC plug (page 147)

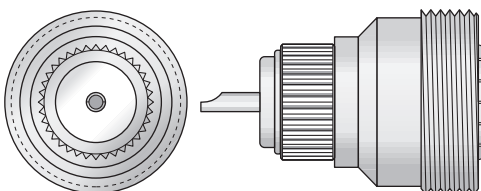

7/16 jack (page 171)

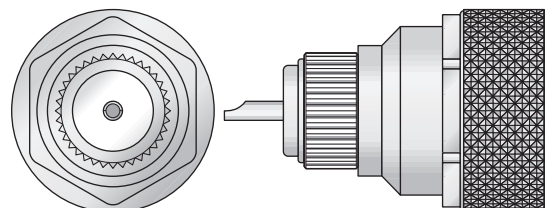

7/16 plug (page 173)

Heli-Grip - Cable Attachment for Flexible Cable

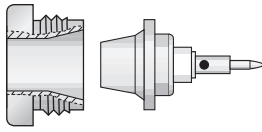

Backnut; cone/contact/
insulator subassembly

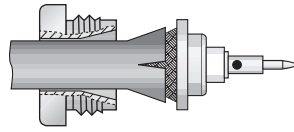

Cable assembled to
hardware subassembly

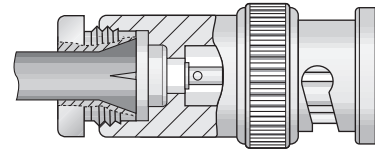

(Proportions altered to illustrate detail)
As assembled in connector

With their reduced parts count and rapid assembly, Delta's Heli-Grip connectors offer you significant time savings in your cable assembly operation, without the need for dedicated crimp tools.

Heli-Grip connectors all have captivated contacts, and assembly is easy—simply trim the cable, slide the trimmed cable into the cone/insulator/contact assembly (left), solder the center conductor to the contact, and screw the body assembly (right) onto the backend assembly.

The assembled connectors have cable retention strength greater than the force required to tear the cable braid.

Standard Heli-Grip Configurations

BNC Series

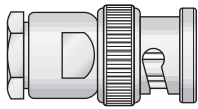

Straight plug—page 14

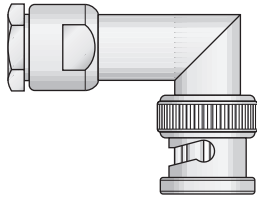

Right angle plug—page 16

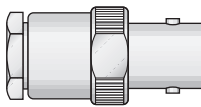

Straight jack—page 17

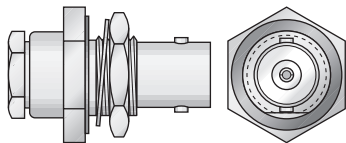

Bulkhead jack—page 19

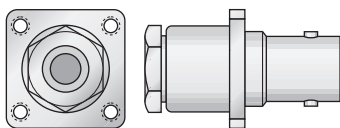

Panel jack—page 21

N Series

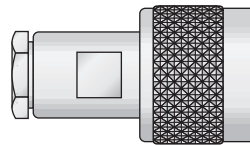

Straight plug—page 69

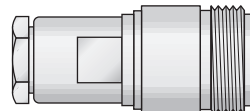

Straight jack—page 73

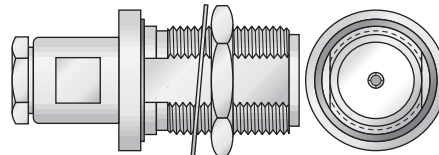

Bulkhead jack—page 75

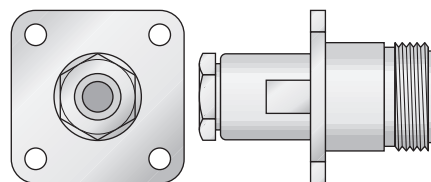

Panel jack—page 77

TNC Series

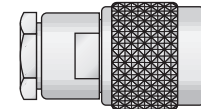

Straight plug—page 138

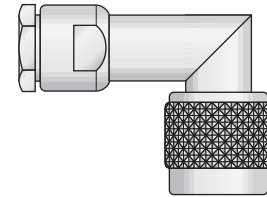

Right angle plug—page 140

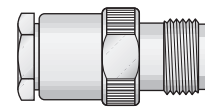

Straight jack—page 141

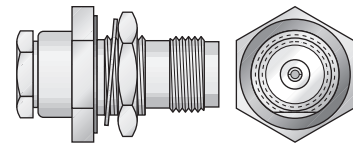

Bulkhead jack—page 142

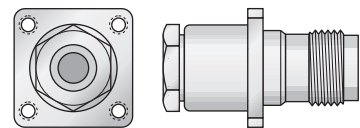

Panel jack—page 143

One-Step Cable Attachment for Semi-Rigid Cable

(Available for N, SC, TNC, and 7/16 connector series as noted in product pages)

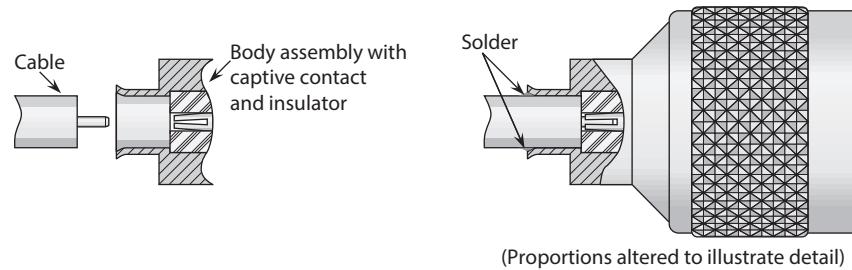

Delta One-Step connectors for semi-rigid cable have captivated contacts and insulators preassembled in the body assembly. With no loose parts to handle, assembly is as simple as trimming the cable (and chamfering the cable center conductor), inserting the cable into the body assembly, and soldering the cable jacket to the connector body. The internal design of the body assembly automatically maintains the proper gap distance between the center contact and the cable dielectric, ensuring the best electrical performance and eliminating the shimming operation required by connectors with non-captive contacts.

Standard One-Step Configurations

N Series

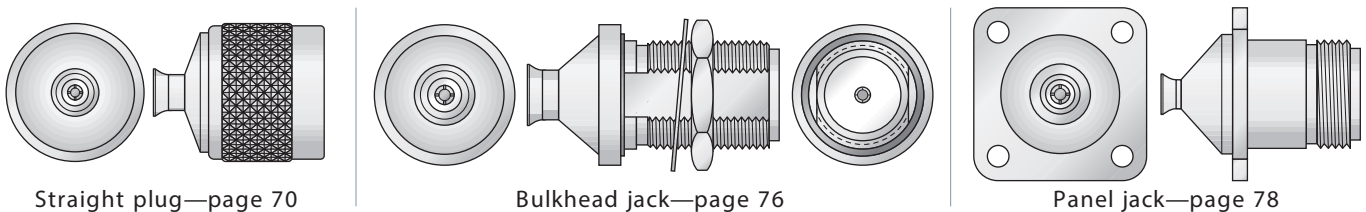

SMA Series

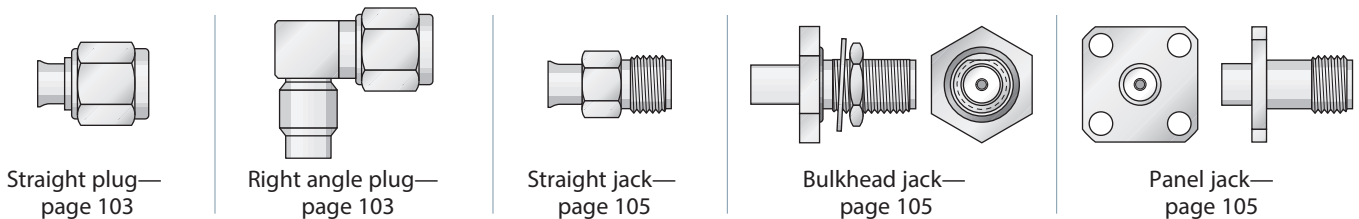

Coupling Nut Options

(Available for N, SC, TNC, and 7/16 connector series as noted in product pages)

Any plug in N, SC, TNC, or 7/16 series can be supplied with a hex coupling nut for applications requiring plugs to be torqued to a specific value. Please call for part numbers of specific connectors with hex coupling nuts, which can be supplied with or without safety-wire holes.

Note: Delta's standard coupling nut design for 7/16 connectors features wrench flats as well as a knurled surface for hand-tightening, but 7/16 connectors can also be supplied with full hex coupling nuts.

N Series

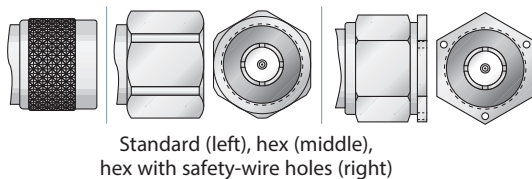

TNC Series

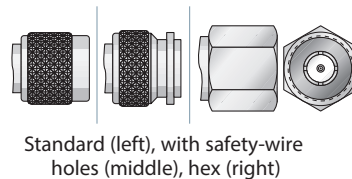

7/16 Series

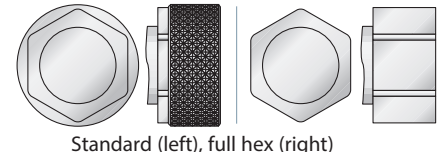

General Description

Delta BMA series plugs are compact, high-performance connectors that mate with all standard BMA series jacks. Designed to meet all applicable MIL-PRF-39012 requirements, they offer good electrical performance up to 22 GHz.

These connectors are ideal for use in rack-and-panel applications.

Current configurations include PressMount plug receptacles and two- and four-hole flange panel plugs with post contacts. New types are being added to our product line, so please call with your requirements for other BMA configurations.

Press Mount Plug Receptacle

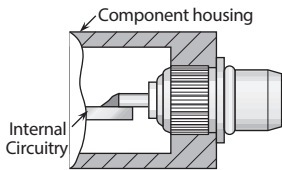

Delta PressMount Receptacles

These connectors eliminate the need for complicated mounting hole patterns and mounting hardware.

They are simply pressed into a single through hole, and the precisely-engineered knurled mounting section provides retention strength far greater than normal mating and unmating forces. An integral shoulder provides a positive stop when mounting.

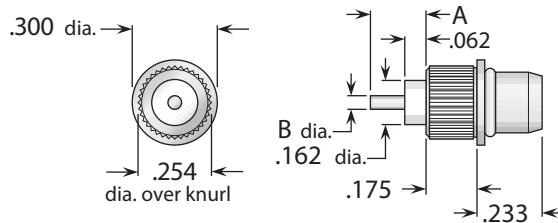

Figure 1 (Brass body)

Figure	Dimensions		Min. Panel	Mounting Hole	Plating		Delta P/N
	A	B			Body	Contact	
1	.187	.050	.100	.250 ±.001 dia.	Nickel	Gold (C)	4259000N911-002

Panel Plug Receptacles

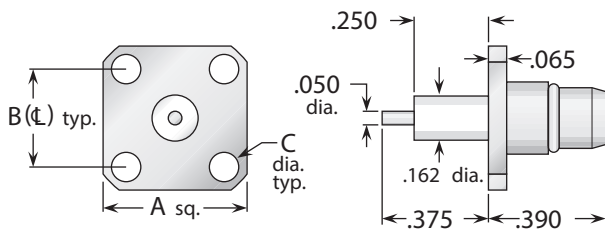

Figure 1 (Stainless steel body)

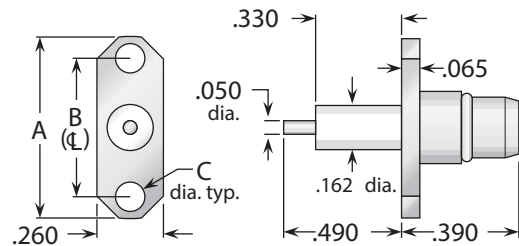

Figure 2 (Stainless steel body)

Figure	Dimensions			Mounting Figure	Plating		Delta P/N
	A	B	C		Body	Contact	
1	.500	.340	.102	05	Passivated	Gold (C)	4259000K051-000
2	.625	.481	.102	92A	Passivated	Gold (C)	4259000K911-005

- (C) in contact plating column indicates captive contact.
- See page 208 for mounting figures.
- Contact factory for specifications and interface dimensions.

General Description

Delta BNC connectors are compact, economical, 50Ω impedance connectors with two-stud bayonet coupling. They are best suited for use with cables in the range of .150" to .250" diameter, but are available for other cables from .090" to over .75" diameter. M39012 QPL BNC connectors and M55339 QPL BNC adapters are also included in this section. Our extensive line of BNC receptacles includes configurations for virtually any packaging requirement, and we can supply any adapter or accessory you may need to complete your system design. Adapters between BNC and other series are shown starting page 176.

As with our other connector series, Delta's customer-driven design results in BNC series connectors with practical and unique features that make your design and assembly process easier. Some of these include:

- Heli-Grip cable connectors for fast, reliable assembly to flexible cable without special tooling.
- PressMount receptacles (page 27) mount securely in a single round hole, saving space on your components and reducing your housing fabrication costs.
- Panel receptacles with flange sizes to match the same hole pattern as standard SMA or type N connectors, letting you drill one hole pattern and mount BNC, N, SMA, TNC, or 7/16 series connectors as needed.
- Isolated ground receptacles (see page 25).
- 75Ω impedance BNC connectors (see page 31) for matched-impedance applications.

Our BNC series product line is still growing, so please call if you don't see what you need.

BNC Configurations

Straight Cable Plugs	13	Bulkhead Jack Receptacles	24
Right Angle Cable Plugs	15	Bulkhead Plug Receptacles	25
Straight Cable Jacks	17	Printed-Circuit Board Receptacles	26
Bulkhead Cable Jacks	18	Stripline Receptacles	26
Panel Cable Jacks	20	PressMount Receptacles	27
Panel Jack Receptacles (square flange)	22	Resistive Terminations	28
Right Angle Panel Jack Receptacles	23	Dust Caps	28
Panel Plug Receptacles	23	In-Series Adapters	29

BNC Specifications*

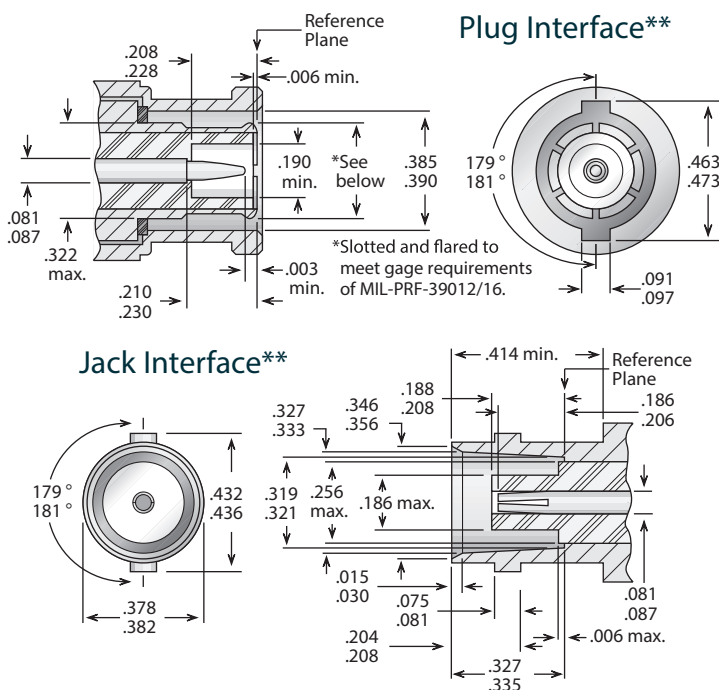

**Some proportions altered to illustrate detail.

Electrical:

Nominal Impedance: 50 ohms.
 Frequency Range: DC-4 GHz.
 Voltage Rating: 500 volts RMS.
 Dielectric Withstanding Voltage: 1,500 VRMS.
 Insulation Resistance: 5,000 megohms.

Materials/Finishes:

Insulators: Teflon per ASTM D1710.
 Male Contacts: Brass per ASTM B16.
 Female Contacts: Beryllium Copper per ASTM B196.
 Contact Plating: Silver - ASTM-B700
 Gold - MIL-DTL-45204.

Gaskets: Silicone rubber per ZZ-R-765, Class II, Grade 50.

Other Metal Parts: Brass per ASTM B16

Plated: Silver - ASTM B700

Nickel - AMS-QQ-N-290.

All other specifications are in accordance with the latest issues of MIL-PRF-39012, or MIL-A-55339, or other applicable MIL specifications, and interfaces are in accordance with MIL-STD-348.

*These specifications are typical and may not apply to all connectors. Detailed specifications for individual connectors are available on request.

Straight Plug - Military Clamp For Flexible Cable

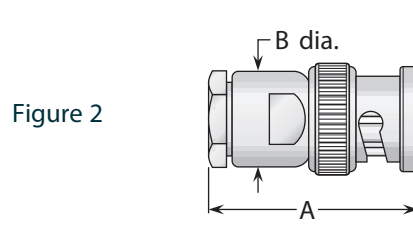
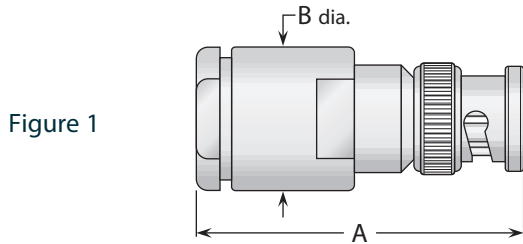

Cable Group	Figure	Dimensions		Plating		Delta P/N	Assembly Procedure/ Trim Code
		A	B	Body	Contact		
1	1	1.16	.560	Nickel	Silver	1001001N000-001	C/06
2, 3	1	1.66	.750	Nickel	Silver	UG-959A/U	A/01
2, 3	1	1.66	.750	Silver	Gold (C)	M39012/16-0225	A/01
5, 6	2	1.03	.440	Nickel	Silver	UG-88/U	C/04
5, 6	2	1.06	.500	Nickel	Silver	UG-88C/U	A/17
5, 6	2	1.06	.500	Nickel	Silver	UG-88E/U	A/17
5, 6	2	1.06	.500	Nickel	Gold (C)	1001015N001-000	A/17
5, 6	2	1.06	.500	Silver	Gold (C)	M39012/16-0101	A/17
7	2	1.03	.440	Nickel	Silver	UG-260/U	C/04
7	2	1.06	.500	Nickel	Silver	UG-260B/U	A/17
7	2	1.06	.500	Nickel	Silver	UG-260D/U	A/17
7	2	1.06	.500	Nickel	Silver (C)	1001021N001-000	A/17
7	2	1.06	.500	Silver	Gold (C)	M39012/16-0102	A/17
8A	2	1.06	.500	Nickel	Silver	UG-1033C/U	A/17
8A	2	1.06	.500	Nickel	Silver (C)	1001029N001-000	A/17
8A	2	1.06	.500	Silver	Gold (C)	M39012/16-0103	A/17
8B	2	1.06	.500	Nickel	Silver	1001043N000-000	A/17
8B	2	1.06	.500	Nickel	Silver (C)	1001043N001-000	A/17
9	2	1.06	.500	Nickel	Silver	1001036N000-000	A/18
9	2	1.06	.500	Nickel	Silver (C)	1001036N001-000	A/18
9	2	1.06	.500	Silver	Gold (C)	M39012/16-0220	A/37
11	2	1.06	.500	Nickel	Silver	1001038N000-000	A/18
22	2	1.06	.500	Silver	Gold (C)	M39012/16-0118	A/17
23	2	1.06	.500	Silver	Gold (C)	M39012/16-0111	A/17
25	2	1.06	.500	Nickel	Silver	1001132N000-000	A/17

Straight Plug - Solder Clamp For Semi-Rigid Cable

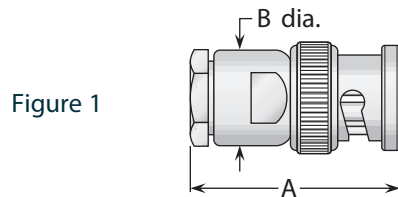

Cable Group	Figure	Dimensions		Plating		Delta P/N	Assembly Procedure/ Trim Code
		A	B	Body	Contact		
13	1	1.06	.500	Nickel*	Silver	1001031N003-000	F/08
14	1	1.06	.500	Nickel*	Silver	1001025N003-000	F/07

* Solder ferrule is gold plated.

- See page 209 for cable groups.
- Assembly procedures start on page 210.
- (C) in contact plating column indicates captive contact.
- See page 6 for alternate body plating information.

Straight Plug - Heli-Grip® For Flexible Cable

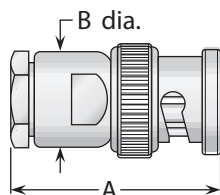
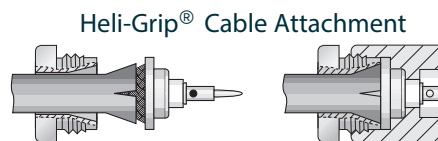

Figure 1



These connectors have captivated contacts and allow rapid, easy assembly—simply trim the cable, slide into the cone/insulator/contact assembly (left), solder the center conductor to the contact, and screw body assembly (right) onto cable assembly.

Cable Group	Figure	Dimensions		Plating		Delta P/N	Assembly Procedure/ Trim Code
		A	B	Body	Contact		
5, 6 [§]	1	1.06	.500	Nickel	Silver (C)	1001018N005-000	E/03
RG-223	1	1.06	.500	Nickel	Silver (C)	1001015N005-003	E/03
7	1	1.06	.500	Nickel	Silver (C)	1001019N005-000	E/03
8A	1	1.06	.500	Nickel	Silver (C)	1001029N005-001	E/03
8B	1	1.06	.500	Nickel	Silver (C)	1001043N005-000	E/03
9	1	1.06	.500	Nickel	Silver (C)	1001037N005-000	E/03
10	1	1.06	.500	Nickel	Silver (C)	1001100N005-000	E/03
11	1	1.06	.500	Nickel	Silver (C)	1001038N005-000	E/03

[§]Except RG-223/U.

Straight Plug - Crimp Type For Flexible Cable

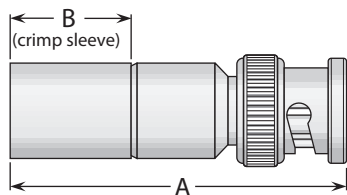

Figure 1

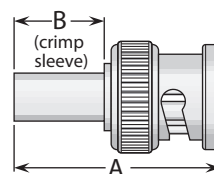

Figure 2

Cable Group	Figure	Dimensions		Plating		Delta P/N	Assembly Procedure/ Trim Code
		A	B	Body	Contact		
3A, 4	1	1.72	.630	Nickel	Gold (C)	1003005N000-000	B/11
5	2	1.09	.500	Nickel	Gold	1003017N000-000	B/18
5	2	1.10	.500	Nickel	Gold (C)	1003017N00E-002	B/19
6	2	1.09	.500	Nickel	Gold	1003013N000-000	B/18
6	2	1.10	.500	Nickel	Gold (C)	1003013N00E-000	B/19
7	2	1.09	.500	Nickel	Gold	1003020N000-002	B/18
7	2	1.10	.500	Nickel	Gold (C)	1003019N00E-002	B/19
7	2	1.05	.410	Nickel	Silver	1003020N000-005 *	***
7	2	1.05	.410	Nickel	Gold	1003020N000-006 *	***
7	2	1.05	.500	Nickel	Silver (C)	1003020N001-005 *	***
7	2	1.05	.500	Nickel	Gold (C)	1003020N001-009 *	***
9	2	.940	.310	Nickel	Silver (C)	1003037N000-000	B/20

* Crimp center contact.

- See page 209 for cable groups.
- Assembly procedures start on page 210.
- (C) in contact plating column indicates captive contact.
- See page 6 for alternate body plating information.
- ***Contact factory for cable assembly instructions.

Right Angle Plug - Military Clamp For Flexible Cable

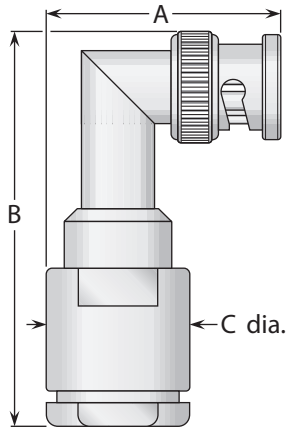

Figure 1

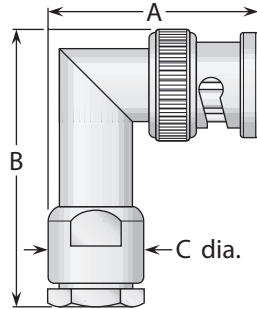

Figure 2

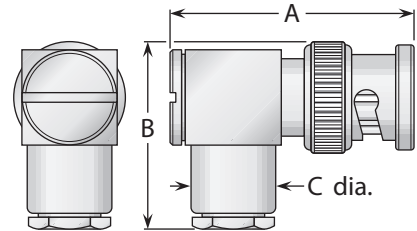

Figure 3

Cable Group	Figure	Dimensions			Plating		Delta P/N	Assembly Procedure/ Trim Code
		A	B	C	Body	Contact		
1	1	1.23	1.92	.750	Nickel	Gold	1004001N000-000	A/07
2,3	1	1.23	1.92	.750	Nickel	Silver	1004004N000-000	A/07
5,6	2	1.09	1.61	.500	Nickel	Silver	UG-913/U	A/17
5,6	2	1.09	1.61	.500	Nickel	Silver	UG-913A/U	A/17
5,6	2	1.09	1.61	.500	Nickel	Silver (C)	1004015N001-000	A/17
5,6	2	1.09	1.61	.500	Silver	Gold (C)	M39012/20-0101	A/17
5,6	3	1.25	1.06	.440	Nickel	Silver (C)	1005014N000-000	C/05
7	2	1.09	1.61	.500	Nickel	Silver	1004021N000-000	A/17
7	2	1.09	1.61	.500	Nickel	Silver (C)	1004021N001-000	A/17
7	2	1.09	1.61	.500	Silver	Gold (C)	M39012/20-0102	A/17
7	3	1.25	1.06	.440	Nickel	Silver (C)	1005021N000-001	C/05
8A	3	1.25	1.06	.440	Nickel	Silver (C)	1005029N000-000	C/05
8B	2	1.09	1.61	.500	Nickel	Silver	1004043N000-000	A/17
9	2	1.09	1.61	.500	Nickel	Silver	1004036N000-000	A/18
9	3	1.25	1.06	.440	Nickel	Silver (C)	1005036N000-000	C/05
22	2	1.09	1.61	.500	Silver	Gold (C)	M39012/20-0108	A/17

Right Angle Plug - Solder Clamp For Semi-Rigid Cable

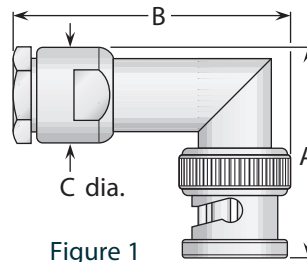

Figure 1

Cable Group	Figure	Dimensions			Plating		Delta P/N	Assembly Procedure/ Trim Code
		A	B	C	Body	Contact		
13	1	1.09	1.61	.500	Nickel*	Silver	1004031N003-000	F/08
14	1	1.09	1.61	.500	Nickel*	Silver	1004025N003-000	F/07

* Solder ferrule is gold plated.

- See page 209 for cable groups.
- Assembly procedures start on page 210.
- (C) in contact plating column indicates captive contact.
- See page 6 for alternate body plating information.

Right Angle Plug - Heli-Grip® For Flexible Cable

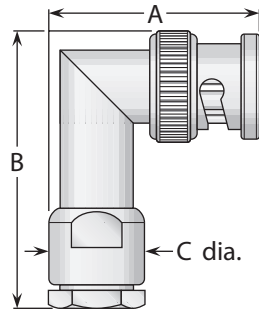
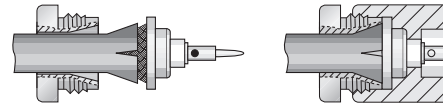

Figure 1

Heli-Grip® Cable Attachment



These connectors have captivated contacts and allow rapid, easy assembly—simply trim the cable, slide into the cone/insulator/contact assembly (left), solder the center conductor to the contact, and screw body assembly (right) onto cable assembly.

Cable Group	Figure	Dimensions			Plating		Delta P/N	Assembly Procedure/ Trim Code
		A	B	C	Body	Contact		
5, 6 [§]	1	1.09	1.61	.500	Nickel	Silver (C)	1004018N005-000	E/03
RG-223	1	1.09	1.61	.500	Nickel	Silver (C)	1004015N005-000	E/03
7	1	1.09	1.61	.500	Nickel	Silver (C)	1004019N005-000	E/03
8A	1	1.09	1.61	.500	Nickel	Silver (C)	1004029N005-000	E/03
8B	1	1.09	1.61	.500	Nickel	Silver (C)	1004043N005-000	E/03
9	1	1.09	1.61	.500	Nickel	Silver (C)	1004037N005-000	E/03
10	1	1.09	1.61	.500	Nickel	Silver (C)	1004100N005-000	E/03
11	1	1.09	1.61	.500	Nickel	Silver (C)	1004038N005-000	E/03

[§]Except RG-223/U.

Right Angle Plug - Crimp Type For Flexible Cable

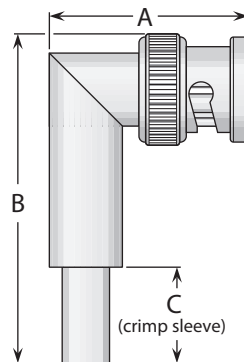

Figure 1

Cable Group	Figure	Dimensions			Plating		Delta P/N	Assembly Procedure/ Trim Code
		A	B	C	Body	Contact		
5	1	1.03	1.71	.500	Nickel	Gold (C)	1007017N000-003	B/02
6	1	1.03	1.71	.500	Nickel	Silver	1007015N000-000	B/02
7	1	1.03	1.71	.500	Nickel	Gold	1007019N000-001	B/02

- See page 209 for cable groups.
- Assembly procedures start on page 210.
- (C) in contact plating column indicates captive contact.
- See page 6 for alternate body plating information.

Straight Jacks - For Flexible & Semi-Rigid Cable

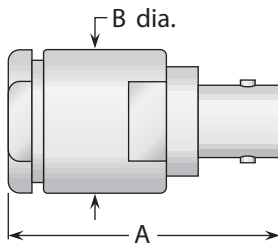

Figure 1

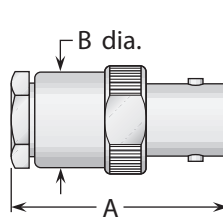

Figure 2

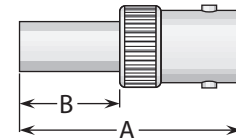
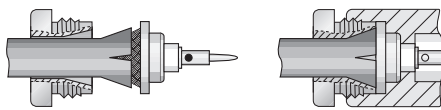

Figure 3

Heli-Grip® Cable Attachment



These connectors have captivated contacts and allow rapid, easy assembly—simply trim the cable, slide into the cone/insulator/contact assembly (left), solder the center conductor to the contact, and screw body assembly (right) onto cable assembly.

Military Clamp For Flexible Cable

Cable Group	Figure	Dimensions		Plating		Delta P/N	Assembly Procedure/ Trim Code
		A	B	Body	Contact		
2,3	1	1.75	.750	Nickel	Silver	1008004N000-000	A/20
5,6	2	1.16	.500	Nickel	Silver	UG-89C/U	A/17
5,6	2	1.16	.500	Nickel	Gold (C)	1008015N001-000	A/17
5,6	2	1.16	.500	Silver	Gold (C)	M39012/17-0101	A/17
7	2	1.16	.500	Nickel	Silver	UG-261C/U	A/17
7	2	1.16	.500	Nickel	Silver (C)	1008021N001-000	A/17
7	2	1.16	.500	Silver	Gold (C)	M39012/17-0102	A/17
8A	2	1.16	.500	Silver	Gold (C)	M39012/17-0103	A/17
9	2	1.16	.500	Nickel	Silver	1008036N000-000	A/18
9	2	1.16	.500	Nickel	Silver (C)	1008036N001-000	A/18
11	2	1.16	.500	Nickel	Silver	1008038N000-000	A/18
22	2	1.16	.500	Silver	Gold (C)	M39012/17-0118	A/17
23	2	1.16	.500	Silver	Gold (C)	M39012/17-0111	A/17

Heli-Grip For Flexible Cable

5,6 [§]	2	1.16	.500	Nickel	Silver (C)	1008018N005-001	E/03
RG-223	2	1.16	.500	Nickel	Silver (C)	1008015N005-000	E/03
7	2	1.16	.500	Nickel	Silver (C)	1008019N005-000	E/03
8A	2	1.16	.500	Nickel	Silver (C)	1008029N005-000	E/03
8B	2	1.16	.500	Nickel	Silver (C)	1008043N005-000	E/03
9	2	1.16	.500	Nickel	Silver (C)	1008037N005-000	E/03
10	2	1.16	.500	Nickel	Silver (C)	1008100N005-000	E/03
11	2	1.16	.500	Nickel	Silver (C)	1008038N005-002	E/03

Crimp Type For Flexible Cable

5	3	1.16	.500	Nickel	Gold	1010017N000-001	B/05
6	3	1.16	.500	Nickel	Gold	1010013N000-000	B/05
7	3	1.16	.500	Nickel	Gold	1010020N000-000	B/05
7	3	1.06	.410	Nickel	Silver	1010020N001-001 **	***

Solder-Clamp For Semi-Rigid Cable

13	2	1.16	.500	Nickel*	Silver	1008031N003-000	F/08
14	2	1.16	.500	Nickel*	Silver	1008025N003-000	F/07

[§]Except RG-223/U.

*Solder ferrule is gold plated.

- See page 209 for cable groups. • Assembly procedures start on page 210.
- (C) in contact plating column indicates captive contact. • See page 6 for alternate body plating information.
- **Indicates crimp center contact. • ***Contact factory for cable assembly instructions.

Bulkhead Jacks - Military Clamp For Flexible Cable

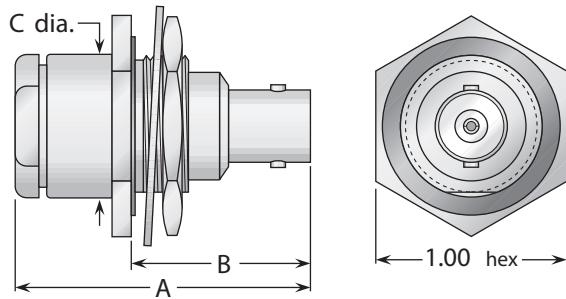

Figure 1
(Rear mount)

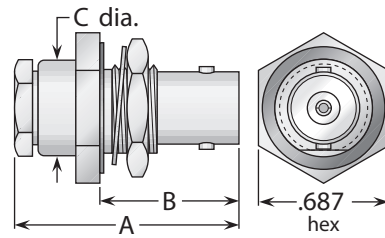

Figure 2
(Rear mount)

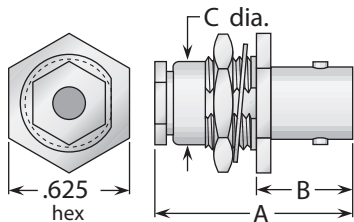

Figure 3
(Front mount)

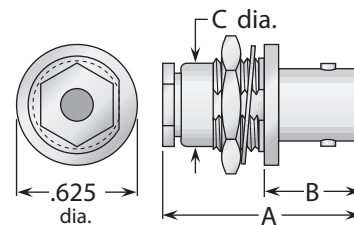

Figure 4
(Front mount)

Cable Group	Fig.	Dimensions			Mounting Figure	Max. Panel	Plating		Delta P/N	Assembly Procedure/Trim Code
		A	B	C			Body	Contact		
2, 3	1	1.55	.920	.750	51	.110	Nickel	Gold (C)	1016004N511-000	A/20
5, 6	2	1.16	.680	.500	59	.110	Nickel	Silver	UG-909/U	A/17
5, 6	2	1.16	.680	.500	59	.110	Nickel	Silver	UG-909A/U	A/17
5, 6	2	1.16	.810	.500	59	.240	Nickel	Silver	UG-909B/U	A/17
5, 6	2	1.16	.810	.500	59	.240	Silver	Gold (C)	M39012/19-0101	A/17
5, 6	2	1.16	.680	.500	59	.110	Nickel	Gold (C)	1016015N591-000	A/17
5, 6	3	1.14	.550	.440	57	.090	Nickel	Silver	1017014N570-000	C/04
7	2	1.16	.680	.500	59	.110	Nickel	Silver	UG-910/U	A/17
7	2	1.16	.680	.500	59	.110	Nickel	Silver	UG-910A/U	A/17
7	2	1.16	.810	.500	59	.240	Nickel	Silver	UG-910B/U	A/17
7	2	1.16	.810	.500	59	.240	Silver	Gold (C)	M39012/19-0102	A/17
7	2	1.16	.680	.500	59	.110	Nickel	Silver (C)	1016021N591-000	A/17
7	4	1.14	.550	.440	57	.090	Nickel	Silver	UG-624/U	C/04
8A	2	1.16	.810	.500	59	.240	Silver	Gold (C)	M39012/19-0110	A/17
9	2	1.16	.680	.500	59	.110	Nickel	Silver	1016036N590-000	A/18
9	2	1.16	.680	.500	59	.110	Nickel	Silver (C)	1016036N591-000	A/17
9	2	1.16	.810	.500	59	.240	Silver	Gold (C)	M39012/19-0220	A/17
11	2	1.16	.680	.500	59	.110	Nickel	Silver	1016038N590-000	A/18
11	2	1.16	.680	.500	59	.110	Nickel	Silver (C)	1016038N591-000	A/18
22	2	1.16	.810	.500	59	.240	Silver	Gold (C)	M39012/19-0118	A/17
23	2	1.16	.810	.500	59	.240	Silver	Gold (C)	M39012/19-0111	A/17

- See page 209 for cable groups.
- Assembly procedures start on page 210.
- See page 208 for mounting dimensions.
- (C) in contact plating column indicates captive contact.
- See page 6 for alternate body plating information.

Bulkhead Jack - Heli-Grip® For Flexible Cable

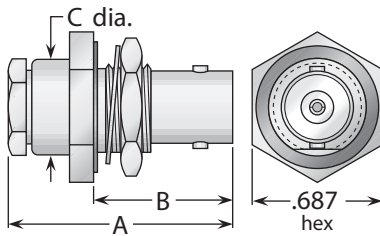
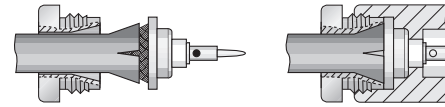

Figure 1 (Rear mount)

Heli-Grip® Cable Attachment



These connectors have captivated contacts and allow rapid, easy assembly—simply trim the cable, slide into the cone/insulator/contact assembly (left), solder the center conductor to the contact, and screw body assembly (right) onto cable assembly.

Cable Group	Fig.	Dimensions			Mounting Figure	Max. Panel	Plating		Delta P/N	Assembly Procedure/Trim Code
		A	B	C			Body	Contact		
5, 6 [§]	1	1.16	.810	.500	59	.240	Nickel	Silver (C)	1016018N595-000	E/03
RG-223	1	1.16	.810	.500	59	.240	Nickel	Silver (C)	1016015N595-000	E/03
7	1	1.16	.810	.500	59	.240	Nickel	Silver (C)	1016019N595-000	E/03
8A	1	1.16	.810	.500	59	.240	Nickel	Silver (C)	1016029N595-000	E/03
8B	1	1.16	.810	.500	59	.240	Nickel	Silver (C)	1016043N595-000	E/03
9	1	1.16	.810	.500	59	.240	Nickel	Silver (C)	1016037N595-000	E/03
10	1	1.16	.810	.500	59	.240	Nickel	Silver (C)	1016100N595-002	E/03
11	1	1.16	.810	.500	59	.240	Nickel	Silver (C)	1016038N595-002	E/03

[§]Except RG-223/U.

Bulkhead Jack - Crimp Type For Flexible Cable

Figure 1 (Rear mount)

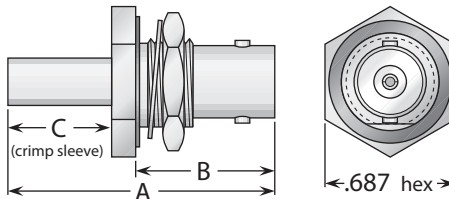

Cable Group	Fig.	Dimensions			Mounting Figure	Max. Panel	Plating		Delta P/N	Assembly Procedure/Trim Code
		A	B	C			Body	Contact		
5	1	1.31	.680	.500	59	.110	Nickel	Silver	1019016N590-000	B/21
6	1	1.31	.680	.500	59	.110	Nickel	Silver	1019013N590-000	B/21
7	1	1.31	.680	.500	59	.110	Nickel	Silver	1019020N590-000	B/22

Bulkhead Jack - Solder Clamp For Semi-Rigid Cable

Figure 1 (Rear mount)

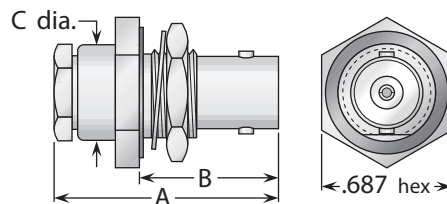

Cable Group	Fig.	Dimensions			Mounting Figure	Max. Panel	Plating		Delta P/N	Assembly Procedure/Trim Code
		A	B	C			Body	Contact		
13	1	1.16	.810	.500	59	.240	Nickel*	Silver	1016031N593-000	F/08
14	1	1.16	.810	.500	59	.240	Nickel*	Silver	1016025N593-000	F/07

* Solder ferrule is gold plated.

- See page 209 for cable groups.
- Assembly procedures start on page 210.
- See page 208 for mounting dimensions.
- (C) in contact plating column indicates captive contact.
- See page 6 for alternate body plating information.

Panel Jack- Military Clamp For Flexible Cable

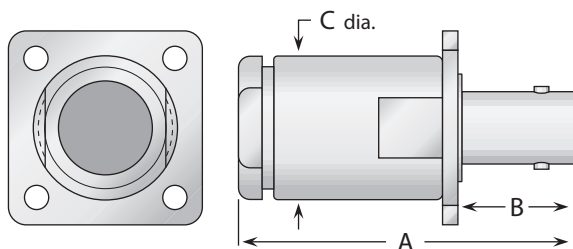

Figure 1

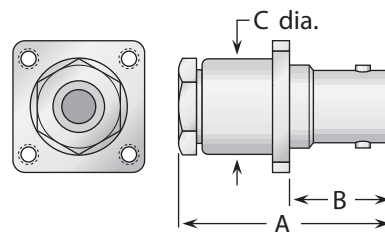

Figure 2

Cable Group	Fig.	Dimensions			Mounting Figure	Plating		Delta P/N	Assembly Procedure/Trim Code
		A	B	C		Body	Contact		
1	1	1.75	.630	.750	33	Nickel	Silver	1011001N330-000	A/20
2, 3	1	1.75	.630	.750	33	Nickel	Silver	1011004N330-000	A/20
5, 6	2	1.16	.550	.500	07	Nickel	Silver	UG-291C/U	A/17
5, 6	2	1.16	.550	.500	07	Silver	Gold (C)	M39012/18-0102	A/17
5, 6	2	1.16	.550	.500	07	Nickel	Gold (C)	1011015N071-000	A/17
7	2	1.16	.550	.500	07	Nickel	Silver	UG-262C/U	A/17
7	2	1.16	.550	.500	07	Silver	Gold (C)	M39012/18-0101	A/17
7	2	1.16	.550	.500	07	Nickel	Silver (C)	1011021N071-000	A/17
8A	2	1.16	.550	.500	07	Silver	Gold (C)	M39012/18-0103	A/17
9	2	1.16	.550	.500	07	Nickel	Silver	1011036N070-000	A/18
9	2	1.16	.550	.500	07	Nickel	Silver (C)	1011036N071-000	A/38
9	2	1.16	.550	.500	07	Silver	Gold (C)	M39012/18-0220	A/38
11	2	1.16	.550	.500	07	Nickel	Silver	1011038N070-000	A/18
11	2	1.16	.550	.500	07	Nickel	Silver (C)	1011038N071-000	A/18
22	2	1.16	.550	.500	07	Silver	Gold (C)	M39012/18-0118	A/17
23	2	1.16	.550	.500	07	Silver	Gold (C)	M39012/18-0111	A/17

Panel Jack - Solder-Clamp For Semi-Rigid Cable

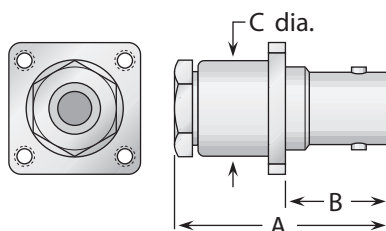

Figure 1

Cable Group	Fig.	Dimensions			Mounting Figure	Plating		Delta P/N	Assembly Procedure/Trim Code
		A	B	C		Body	Contact		
13	1	1.16	.550	.500	07	Nickel*	Gold	1011031N073-000	F/08
14	1	1.16	.550	.500	07	Nickel*	Gold	1011025N073-000	F/07

* Solder ferrule is gold plated.

- See page 209 for cable groups.
- Assembly procedures start on page 210.
- See page 208 for mounting dimensions.
- (C) in contact plating column indicates captive contact.
- See page 6 for alternate body plating information.

Panel Jack- Heli-Grip® For Flexible Cable

Heli-Grip® Cable Attachment

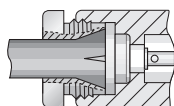
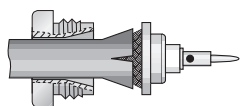

These connectors have captivated contacts and allow rapid, easy assembly—simply trim the cable, slide into the cone/insulator/contact assembly (left), solder the center conductor to the contact, and screw body assembly (right) onto the cable assembly.

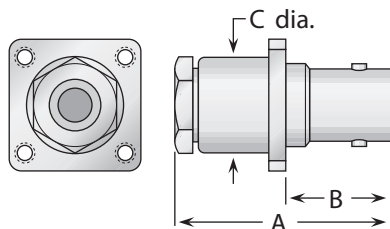

Figure 1

Cable Group	Fig.	Dimensions			Mounting Figure	Plating		Delta P/N	Assembly Procedure/Trim Code
		A	B	C		Body	Contact		
5, 6 [§]	1	1.16	.550	.500	07	Nickel	Silver (C)	1011018N075-000	E/03
RG-223	1	1.16	.550	.500	07	Nickel	Silver (C)	1011015N075-000	E/03
7	1	1.16	.550	.500	07	Nickel	Silver (C)	1011019N075-000	E/03
8A	1	1.16	.550	.500	07	Nickel	Silver (C)	1011029N075-000	E/03
8B	1	1.16	.550	.500	07	Nickel	Silver (C)	1011043N075-000	E/03
9	1	1.16	.550	.500	07	Nickel	Silver (C)	1011037N075-000	E/03
10	1	1.16	.550	.500	07	Nickel	Silver (C)	1011100N075-000	E/03
11	1	1.16	.550	.500	07	Nickel	Silver (C)	1011038N075-000	E/03

[§]Except RG-223/U.

Panel Jack - Crimp Type for Flexible Cable

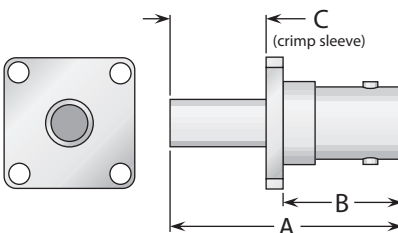

Figure 1

Cable Group	Fig.	Dimensions			Mounting Figure	Plating		Delta P/N	Assembly Procedure/Trim Code
		A	B	C		Body	Contact		
5	1	1.22	.630	.500	09	Nickel	Gold (C)	1055017N091-000	B/12
6	1	1.22	.630	.500	09	Nickel	Gold (C)	1055015N091-000	B/12
7	1	1.22	.630	.500	09	Nickel	Gold (C)	1055019N091-000	B/12

- See page 209 for cable groups.
- Assembly procedures start on page 210.
- See page 208 for mounting dimensions.
- (C) in contact plating column indicates captive contact.
- See page 6 for alternate body plating information.

Panel Jack Receptacles - Square Flange

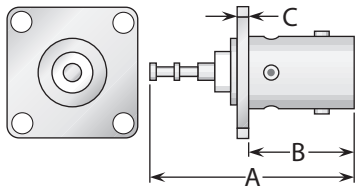

Figure 1
(Turret contact)

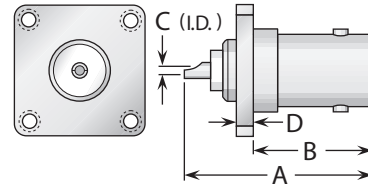

Figure 2
(Solder pot contact)

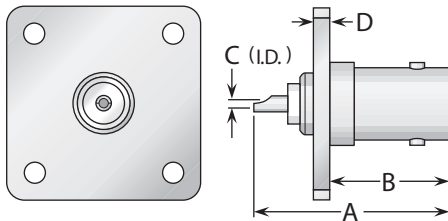

Figure 3
(Solder pot contact, 1" square flange,
interchangeable with type N standard flange size)

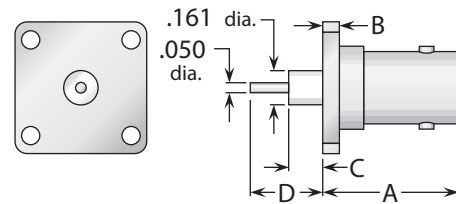

Figure 4
(Post contact)

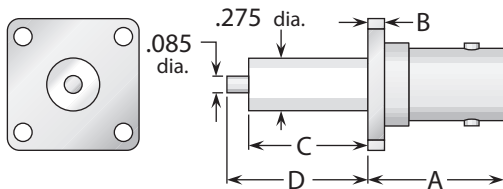

Figure 5
(Post contact)

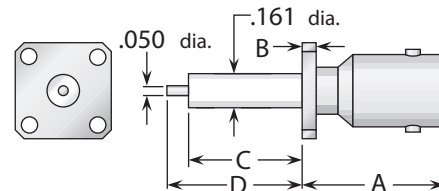

Figure 6
(Post contact, 1/2" square flange,
interchangeable with SMA standard flange size)

Figure	Dimensions				Mounting Figure	Plating		Delta P/N
	A	B	C	D		Body	Contact	
1	1.06	.550	.050	—	18	Nickel	Silver (C)	UG-185/U
2	1.06	.630	.062	.090	07	Nickel	Silver (C)	UG-290A/U
2	1.06	.630	.043	.090	12	Nickel	Silver (C)	UG-447/U
2	1.06	.630	.062	.090	07	Silver	Gold (C)	M39012/22-0001
2	1.06	.630	.062	.090	09	Nickel	Silver (C)	1013000N090-000
2	1.06	.630	.062	.090	10	Nickel	Silver (C)	1013000N100-000
2	1.06	.630	.062	.090	18	Nickel	Gold (C)	1013000N180-000
2	1.00	.750	.062	.080	18 ^s	Nickel	Gold (C)	1013000F181-000**
3	1.06	.630	.062	.080	33	Nickel	Silver (C)	1013000N330-000
4	.715	.090	.175	.375	09	Nickel	Silver (C)	1058000N091-000
5	.750	.080	.590	.705	18 ^s	Nickel	Gold (C)*	1058000N181-001
6	.750	.080	.590	.705	05	Nickel	Gold (C)	1058000N051-000

- (C) in contact plating column indicates captive contact.
- *Indicates epoxy-captivated contact.
- **Insulator flush with rear of flange.
- ^sFlange #18 except with .125 dia. mounting holes.
- See page 6 for alternate body plating information.

- See page 208 for mounting dimensions.
- All items are available with other flange sizes and contact configurations.

Right Angle Panel Jack Receptacles - Square Flange

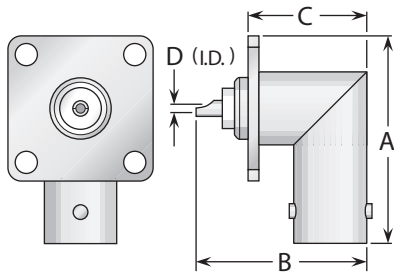

Figure 1
(Solder pot contact)

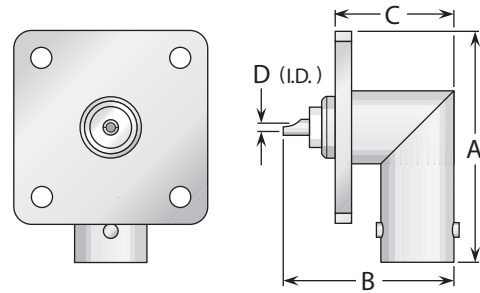

Figure 2
(Solder pot contact, 1" square flange, interchangeable with type N standard flange size)

Figure	Dimensions				Mounting Figure	Plating		Delta P/N
	A	B	C	D		Body	Contact	
1	1.09	.910	.610	.062	18	Nickel	Silver (C)	UG-535/U
1	1.06	.910	.650	.062	07	Nickel	Silver (C)	1015000N070-000
1	1.06	.910	.650	.062	09	Nickel	Gold (C)	1015000N090-000
2	1.22	.910	.610	.062	33	Nickel	Silver (C)	1015000N330-000

Panel Plug Receptacles - Square Flange

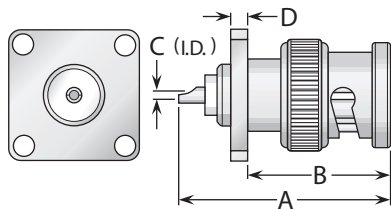

Figure 1
(Solder pot contact, 3/4" square flange)

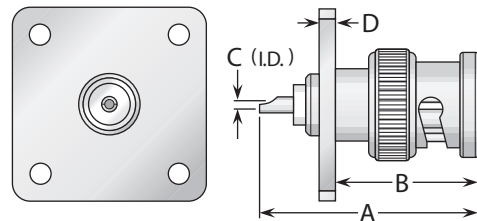
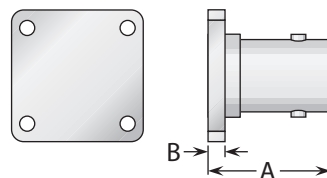

Figure 2
(Solder pot contact, 1" square flange, interchangeable with type N standard flange size)

Figure	Dimensions				Mounting Figure	Plating		Delta P/N
	A	B	C	D		Body	Contact	
1	1.19	.800	.062	.090	18	Nickel	Silver (C)	UG-1104A/U
2	1.19	.800	.062	.080	33	Nickel	Silver (C)	1023000N330-000

Dummy Receptacles



Dimensions		Mounting Figure	Plating		Delta P/N
A	B		Body	Contact	
.750	.090	09	Nickel	—	1063000N090-000

- (C) in contact plating column indicates captive contact.
- See page 6 for alternate body plating information.
- See page 208 for mounting dimensions.
- All items are available with other flange sizes and contact configurations.

Bulkhead Jack Receptacles

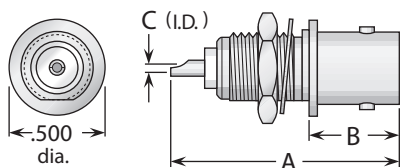

Figure 1
(Front mount)

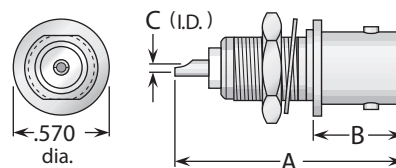

Figure 2
(Front mount, pressurized [non-hermetic], with mounting gasket)

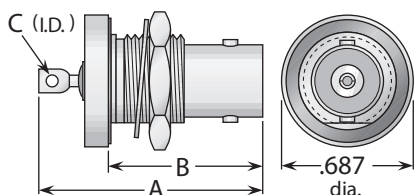

Figure 3
(Rear mount, hermetically sealed, with mounting gasket)

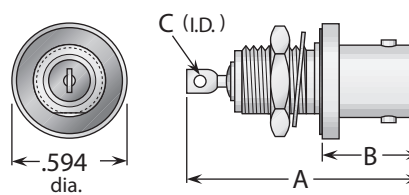

Figure 4
(Front mount, hermetically sealed, with mounting gasket)

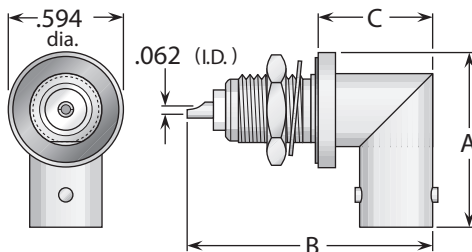

Figure 5
(Right angle, solder pot contact)

Figure	Dimensions			Max. Panel	Mounting Figure	Plating		Delta P/N
	A	B	C			Body	Contact	
1	1.06	.490	.062	.130	62	Nickel	Silver (C)	UG-625B/U
2	1.28	.600	.052	.190	75	Nickel	Silver (C)	UG-657/U
2	1.28	.600	.052	.190	75	Nickel	Silver (C)	UG-657A/U
1	1.06	.470	.062	.130	65	Nickel	Silver (C)	UG-1094/U
1	1.19	.470	.062	.260	65	Nickel	Silver (C)	UG-1094A/U
1	1.06	.490	.062	.130	62	Silver	Gold (C)	M39012/21-0001
1	1.19	.470	.062	.260	65	Silver	Gold (C)	M39012/21-0002
1	1.19	.470	.062	.260	62	Silver	Gold (C)	M39012/21-0003
3	1.20	.830	.062	.260	59	Nickel	Silver (C)	UG-911A/U
3	1.20	.830	.062	.260	59	Silver	Gold (C)	M39012/24-0001
4	1.20	.520	.062	.260	63	Nickel	Silver (C)	UG-912/U
4	1.33	.520	.062	.340	63	Nickel	Silver (C)	UG-912A/U
4	1.20	.520	.062	.260	63	Silver	Gold (C)	M39012/24-0002
5	.920	1.22	.590	.130	63	Nickel	Silver (C)	UG-1098/U
5	.920	1.34	.590	.250	63	Nickel	Silver (C)	UG-1098A/U
5	.920	1.22	.590	.130	62	Nickel	Silver (C)	UG-1174/U

- (C) in contact plating column indicates captive contact.
- See page 6 for alternate body plating information.
- See page 208 for mounting dimensions.
- All items are available with other flange sizes and contact configurations.

Bulkhead Jack Receptacles With Solder Lug

Figure 1
(Standard grounding)

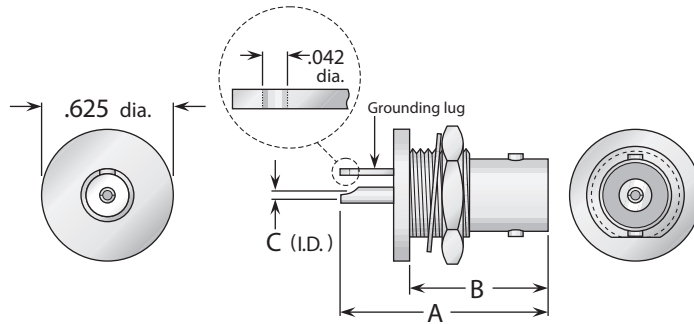

Isolated-Ground Receptacles

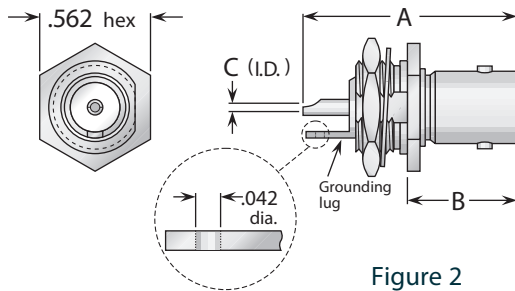
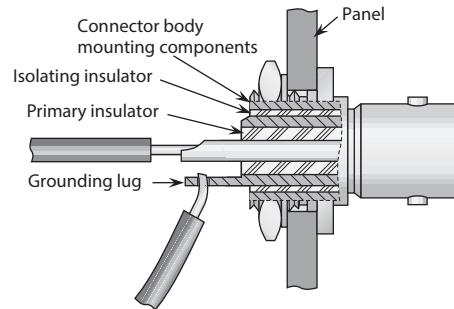

Figure 2
(Isolated ground)



These receptacles feature an additional insulator between the main connector body and the body's mounting surfaces, electrically isolating the ground signal of the circuit from the panel. The circuit ground signal is passed through the panel via the solder lug for termination inside the equipment. Since they are not a triaxial connector design, isolated-ground receptacles can be used with any standard BNC plugs.

Figure	Dimensions			Max. Panel	Mounting Figure	Plating		Delta P/N
	A	B	C			Body	Contact	
1	1.06	.750	.062	.170	59	Nickel	Gold (C)	1021000N591-000
2	1.06	.500	.062	.170	59	Nickel	Gold (C)	1020000F59G-000

Bulkhead Plug Receptacles

Figure 1
(Front mount)

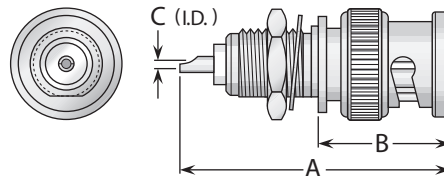

Bulkhead Plug Receptacle

Figure	Dimensions			Max. Panel	Mounting Figure	Plating		Delta P/N
	A	B	C			Body	Contact	
1	1.25	.690	.062	.160	65	Nickel	Silver (C)	1024000N651-000

- (C) in contact plating column indicates captive contact.
- See page 6 for alternate body plating information.
- See page 208 for mounting dimensions.
- All items are available with other flange sizes and contact configurations.

Receptacles For Printed Circuit Boards

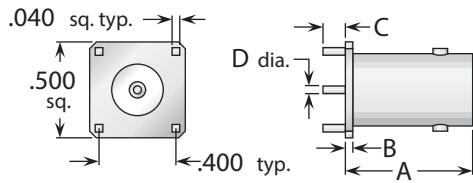

Figure 1

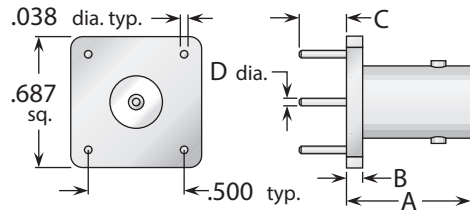

Figure 2

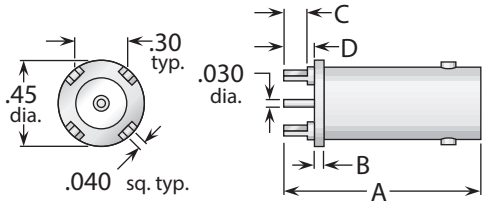

Figure 3

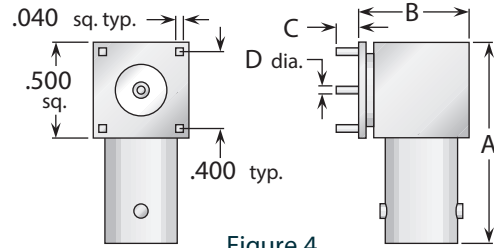

Figure 4

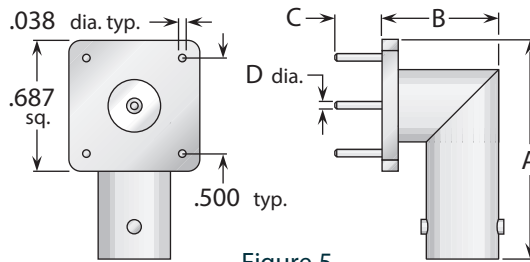

Figure 5

Figure	Dimensions				Max. Board Thickness	Mounting Figure	Plating		Delta P/N
	A	B	C	D			Body	Contact	
1	.660	.040	.116	.040	.063	PCB01	Nickel	Gold (C)	1058000N04P-000
1	1.15	.040	.116	.040	.063	PCB01	Nickel	Gold (C)	1058000N04P-001
2	.650	.085	.250	.038	.125	PCB02	Nickel	Gold (C)	1058000N13P-000
3	1.03	.050	.125	.160	.063	PCB03	Nickel	Silver (C)	1067000N91P-001
4	1.06	.575	.116	.040	.063	PCB01	Nickel	Gold (C)	1069000N03P-000
5	.950	.610	.250	.038	.125	PCB02	Nickel	Gold (C)	1069000N13P-000

Stripline Receptacles

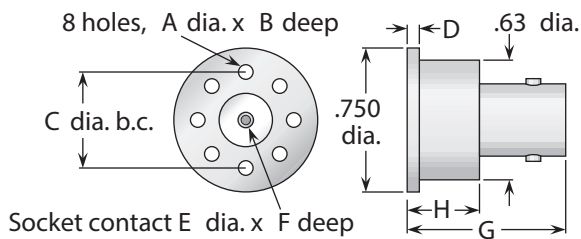

Figure 1

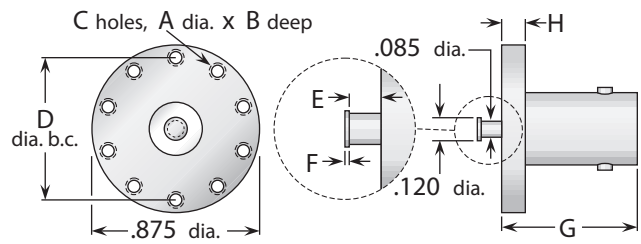

Figure 2

Figure	Dimensions								Plating		Delta P/N
	A	B	C	D	E	F	G	H	Body	Contact	
1	.078	.310	.500	.063	.063	.220	.828	.375	Nickel	Gold (C)	1056000N000-000
2	#2-56	.125	10	.734	.125	.010	.710	.125	Nickel	Gold	1057000N000-000

- (C) in contact plating column indicates captive contact.
- See page 6 for alternate body plating information.
- See page 208 for mounting dimensions.

Press Mount Receptacles

Delta Press Mount Receptacles

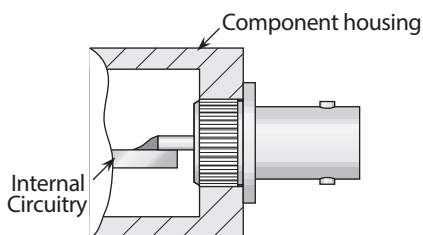

These connectors eliminate the need for complicated mounting hole patterns and mounting hardware.

They are simply pressed into a single through hole, and the precisely-engineered knurled mounting section provides retention strength far greater than normal mating and unmating forces. An integral shoulder provides a positive stop when mounting.

PressMounts are available for a wide variety of Delta connector series, and can be used in packages as small as the outer diameter of the connector body.

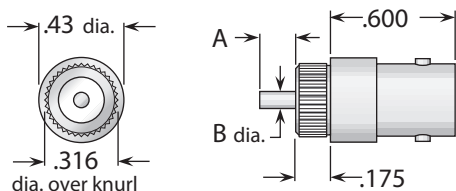

Figure 1
(Post contact)

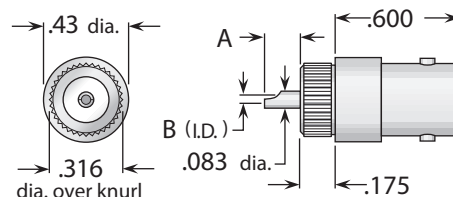

Figure 2
(Solder pot contact)

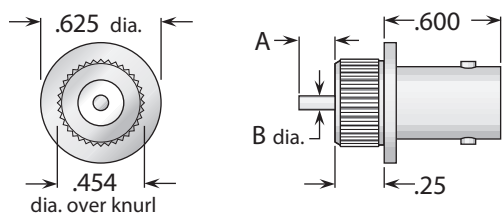

Figure 3
(Post contact)

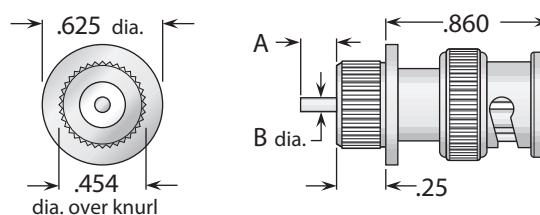
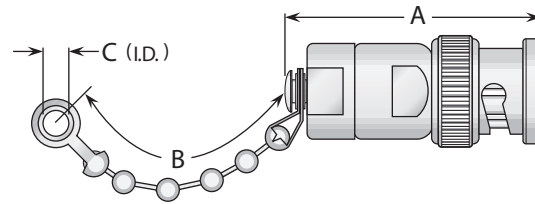

Figure 4
(Plug type, post contact)

Figure	Dimensions		Min. Panel	Mounting Hole	Plating		Delta P/N
	A	B			Body	Contact	
1	.062	.050	.150	.312 ±.001 dia.	Nickel	Silver (C)	1020000N911-001
2	.285	.062	.150	.312 ±.001 dia.	Nickel	Silver (C)	1020000N911-002
3	.060	.050	.200	.450 ±.001 dia.	Nickel	Gold (C)	1020000N911-013
4	.060	.050	.200	.450 ±.001 dia.	Nickel	Gold (C)	1024000N911-004

- (C) in contact plating column indicates captive contact.
- See page 6 for alternate body plating information.
- All items are available with other flange sizes and contact configurations.

Resistive Termination (Plug Type)



Resistor	Dimensions			Features	Plating		Delta P/N
	A	B	C		Body	Contact	
51 Ω ±5%, 1/2 Watt	1.25	3.50	.144		Nickel	Gold (C)	MX-554/U
51 Ω ±5%, 1/2 Watt	1.41	3.50	.144		Nickel	Silver (C)	MX-554A/U
51 Ω ±5%, 1/2 Watt	1.14	—	—	No chain	Nickel	Gold (C)	1031000N00A-003
51 Ω ±5%, 1 Watt	1.50	4.50	.130		Nickel	Silver (C)	1051000N000-000
51 Ω ±5%, 1 Watt	1.39	—	—	No chain	Nickel	Silver (C)	1051000N00A-005
75 Ω ±5%, 1/2 Watt	1.41	3.50	.144		Nickel	Silver (C)	1031000N000-004
75 Ω ±5%, 1/2 Watt	1.14	—	—	No chain	Nickel	Gold (C)	1031000N00A-001
75 Ω ±5%, 1 Watt	1.39	—	—	No chain	Nickel	Silver (C)	1051000N00A-002

Dust Caps

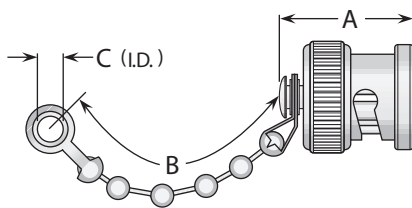

Figure 1
(Shown with bead chain)

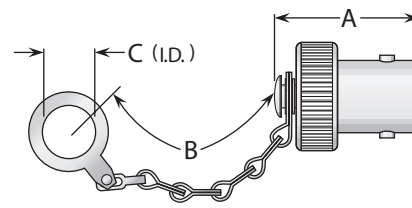
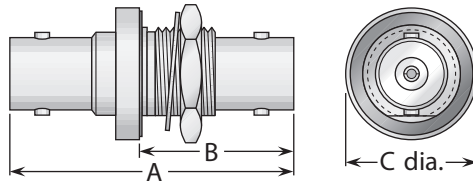

Figure 2
(Shown with safety chain)

Figure	Dimensions			Features	Plating		Delta P/N
	A	B	C		Body	Contact	
1	.670	2.25	.144	Bead chain	Nickel	—	CW-123A/U
1	.590	—	—	No chain	Nickel	—	CW-155A/U
1	.690	2.25	.144	Bead chain / shorting type	Nickel	Silver (C)	CW-159/U
1	.670	2.25	.144	Bead chain	Silver	—	M39012/25-0006
1	.670	2.70	.520	Safety chain	Silver	—	M39012/25-0007
2	.690	3.25	.281	Bead chain	Nickel	—	CW-282/U
2	.690	3.25	.281	Bead chain	Silver	—	M39012/25-0008
2	.690	3.25	.281	Safety chain	Silver	—	M39012/25-0009

- (C) in contact plating column indicates captive contact.
- See page 6 for alternate body plating information.
- Caps and terminations are available with other chain styles and/or resistances.

Bulkhead Jack-Jack Adapter (Connects Two Plugs)



Dimensions			Max. Panel	Mounting Figure	Plating		Delta P/N
A	B	C			Body	Contact	
1.53	.860	.690	.275	59	Nickel	Silver (C)	UG-492A/U *
1.53	.860	.690	.275	59	Nickel	Silver (C)	UG-492C/U *
1.53	.860	.690	.275	59	Nickel	Silver (C)	UG-492D/U *
1.53	.860	.690	.275	59	Silver	Gold (C)	M55339/13-00492 *
1.28	.800	.625	.160	59	Nickel	Silver (C)	1026000N591-000

* Hermetically sealed, with mounting gasket.

Panel Mounted Jack-Jack Adapter (Connects Two Plugs)

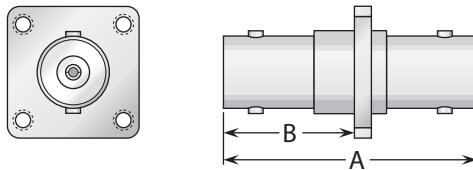

Dimensions		Mounting Figure	Plating		Delta P/N
A	B		Body	Contact	
1.28	.690	07	Nickel	Silver (C)	UG-414A/U

Straight Jack-Jack Adapter (Connects Two Plugs)

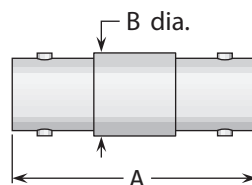

Dimensions		Plating		Delta P/N
A	B	Body	Contact	
1.28	.440	Nickel	Silver (C)	UG-914/U
1.28	.440	Silver	Gold (C)	M55339/16-00914
1.28	.440	Nickel	Gold (C)	1028000N001-003

- (C) in contact plating column indicates captive contact.
- See page 6 for alternate body plating information.
- See page 208 for mounting dimensions.

Straight Plug-Plug Adapter (Connects Two Jacks)

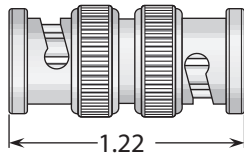

Plating		Delta P/N
Body	Contact	
Nickel	Silver (C)	UG-491B/U
Silver	Gold (C)	M55339/15-00491

Straight Plug-Jack Adapter (Connects One Jack & One Plug)

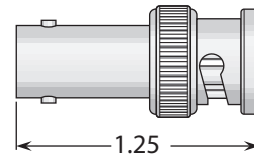

Plating		Delta P/N
Body	Contact	
Nickel	Gold (C)	1034000N000-000

Right Angle & Tee Adapter

Figure 1
(Right angle plug-jack;
connects one plug
and one jack)

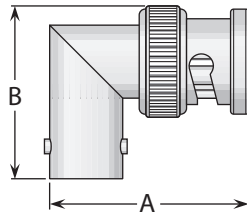

Figure 2
(Tee jack-plug-jack;
connects two plugs
and one jack)

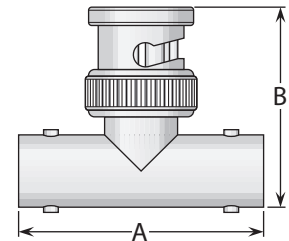

Figure 3
(Tee jack-jack-jack;
connects three plugs)

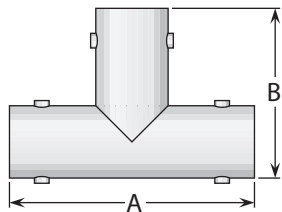

Figure 4
(Tee jack-jack-plug;
connects two plugs
and one jack)

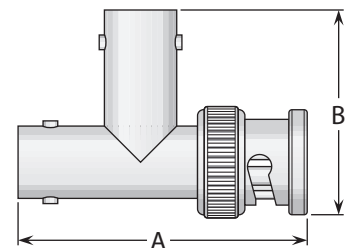

Figure	Dimensions		Plating		Delta P/N
	A	B	Body	Contact	
1	1.06	.880	Nickel	Silver (C)	UG-306A/U
1	1.06	.880	Nickel	Silver (C)	UG-306B/U
1	1.06	.880	Silver	Gold (C)	M55339/14-00306
1	1.06	.880	Nickel	Gold (C)	1029000N000-003
2	1.28	1.03	Nickel	Silver (C)	UG-274A/U
2	1.28	1.03	Nickel	Silver (C)	UG-274B/U
2	1.28	1.03	Nickel	Gold (C)	UG-274C/U
2	1.28	1.03	Silver	Gold (C)	M55339/17-00274
3	1.28	.890	Nickel	Silver (C)	1038000N000-002
3	1.28	.970	Silver	Gold (C)	M55339/17-00002
4	1.50	1.06	Nickel	Silver (C)	1049000N000-000
4	1.50	1.06	Silver	Gold (C)	M55339/17-00001

• (C) in contact plating column indicates captive contact.

• See page 6 for alternate body plating information.

BNC75 Configurations

Straight Cable Plugs	31	Panel Plug Receptacles.....	32
Right Angle Cable Plugs	31	Printed-Circuit Board Receptacles	32
Bulkhead Cable Jacks	31	Bulkhead Jack Receptacles	33
Panel Jack Receptacles (square flange)	32	In-Series Adapters	33

Straight & Right Angle Plugs For Flexible Cable

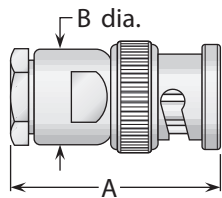

Figure 1
(Heli-Grip[®] cable hardware)

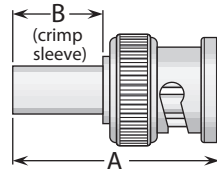

Figure 2
(Crimp type)

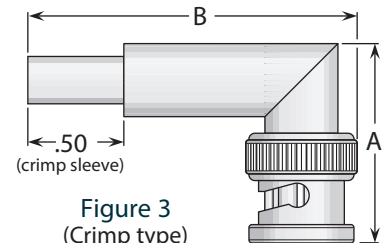
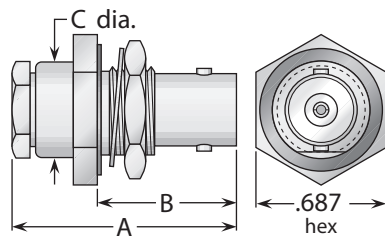

Figure 3
(Crimp type)

Cable Group	Figure	Dimensions		Plating		Delta P/N	Assembly Procedure/ Trim Code
		A	B	Body	Contact		
7	1	1.06	.500	Nickel	Silver (C)	7501019N005-000	E/03
7	2	1.09	.500	Nickel	Gold	7503020N000-002	B/19
7	2	1.05	.410	Nickel	Gold (C)	7503020N001-000	B/26
7	3	1.03	1.71	Nickel	Gold	7507019N000-000	B/02
9	1	1.06	.500	Nickel	Silver (C)	7501037N005-000	E/03
9	2	1.13	.390	Nickel	Gold	7503037N001-000	B/27
9	3	1.03	1.71	Nickel	Gold	7507037N000-000	B/02
26	2	1.10	.450	Nickel	Gold (C)	7503108N001-000	B/26
31	2	1.13	.500	Nickel	Gold	7503279N001-000	B/19

Bulkhead Jack - Heli-Grip[®] For Flexible Cable

Figure 1
(Rear mount)



Heli-Grip[®] Cable Attachment

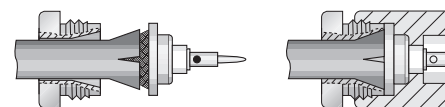

These connectors have captivated contacts and allow rapid, easy assembly—simply trim the cable, slide into the cone/insulator/contact assembly (left), solder the center conductor to the contact, and screw body assembly (right) onto cable assembly.

Cable Group	Fig.	Dimensions			Mounting Figure	Max. Panel	Plating		Delta P/N	Assembly Procedure/ Trim Code
		A	B	C			Body	Contact		
7	1	1.16	.810	.500	59	.240	Nickel	Gold (C)	7516019N595-000	E/03
9	1	1.16	.810	.500	59	.240	Nickel	Gold (C)	7516037N595-000	E/03

- See page 209 for cable groups.
- Assembly procedures start on page 210.
- See page 208 for mounting dimensions.
- (C) in contact plating column indicates captive contact.
- See page 6 for alternate body plating information.

Panel Jack & Plug Receptacles - Square Flange

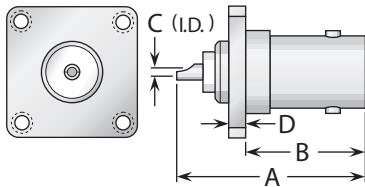

Figure 1
(Solder pot contact, 1¹/₁₆" square flange)

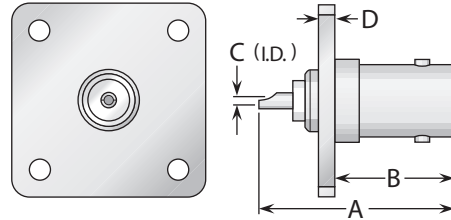

Figure 2
(Solder pot contact, 1" square flange, interchangeable with type N standard flange size)

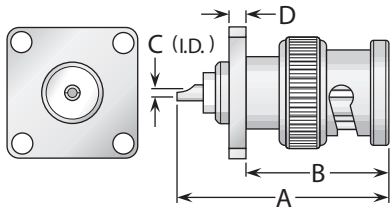

Figure 3
(Solder pot contact, 3/4" square flange)

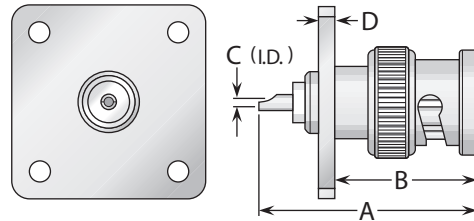

Figure 4
(Solder pot contact, 1" square flange, interchangeable with type N standard flange size)

Figure	Dimensions				Mounting Figure	Plating		Delta P/N
	A	B	C	D		Body	Contact	
1	1.06	.630	.030	.090	09	Nickel	Gold (C)	7513000N091-000
2	1.06	.630	.030	.080	33	Nickel	Gold (C)	7513000N331-002
3	1.19	.800	.030	.090	18	Nickel	Gold (C)	7523000N180-000
4	1.19	.800	.030	.080	33	Nickel	Gold (C)	7523000N331-001

Receptacles For Printed Circuit Boards

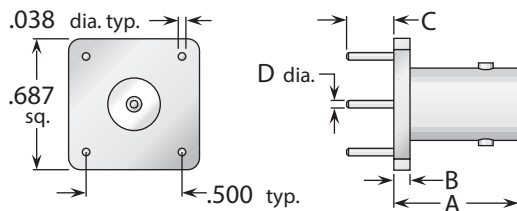

Figure 1

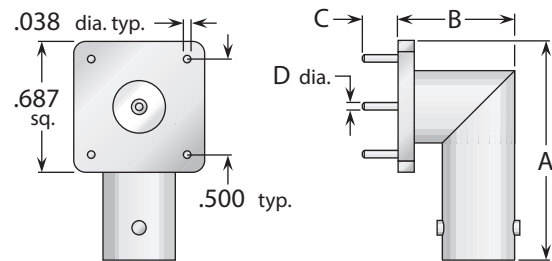

Figure 2

Figure	Dimensions				Max. Board Thickness	Mounting Figure	Plating		Delta P/N
	A	B	C	D			Body	Contact	
1	.650	.085	.250	.038	.125	PCB02	Nickel	Gold (C)	7567000N13P-001
2	1.34	.520	.125	.038	.063	PCB02	Nickel	Silver (C)	7569000N13P-000

(C) in contact plating column indicates captive contact. • See page 208 for mounting dimensions.
See page 6 for alternate body plating information.

Bulkhead Jack Receptacles

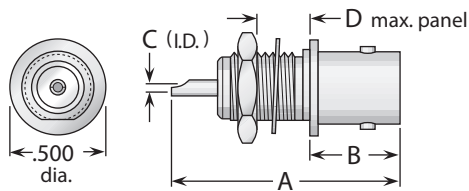

Figure 1
(D-hole mounting)

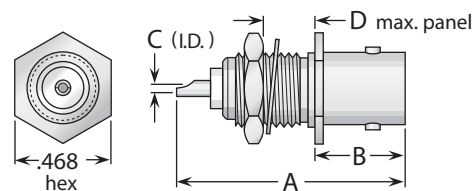
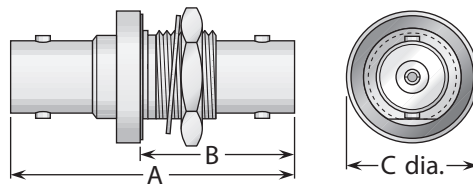

Figure 2
(Round hole mounting)

Figure	Dimensions				Mounting Figure	Plating		Delta P/N
	A	B	C	D		Body	Contact	
1	1.06	.570	.030	.130	65	Nickel	Gold (C)	752000N651-001
2	1.06	.470	.030	.130	89	Nickel	Gold (C)	752100N621-002

Bulkhead Jack - Jack Adapter (Connect Two Plugs)



Dimensions			Max. Panel	Mounting Figure	Plating		Delta P/N
A	B	C			Body	Contact	
1.28	.760	.625	.160	59	Nickel	Silver (C)	752600N591-000 *
1.28	.800	.625	.160	59	Nickel	Silver (C)	752600N591-001

Straight & Right Angle Adapters

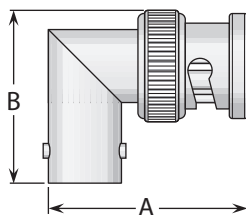

Figure 1
(Right angle plug-jack;
connects one plug and one jack)

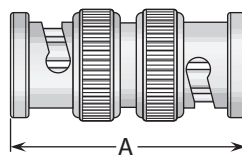

Figure 2
(Straight plug-plug;
connects two jacks)

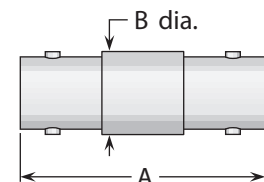

Figure 3
(Straight jack-jack;
connects two plugs)

Figure	Dimensions		Plating		Delta P/N
	A	B	Body	Contact	
1	1.06	.880	Nickel	Gold (C)	752900N000-000
2	1.22	—	Nickel	Gold (C)	752700N001-000
3	1.28	.440	Nickel	Gold (C)	752800N001-000

- (C) in contact plating column indicates captive contact.
- See page 6 for alternate body plating information.
- See page 208 for mounting dimensions.
- *Isolated ground mounting.

General Description

Delta C series connectors are medium-size, 50Ω impedance connectors with two-stud bayonet coupling and good power handling capability, particularly those connectors noted as high-voltage types. They are best suited for use with cables in the range of .350" to .450" diameter, but are available for other cables from .100" to over 1" diameter. Our extensive line of C receptacles includes configurations for virtually any packaging requirement, and we can supply any adapter or accessory you need to complete your system design. Adapters between C and other series are shown starting on page 176.

As with our other connector series, Delta's customer-driven design results in C series connectors with practical and unique features that make your design and assembly process easier. Some of these include:

- High-voltage types for high-power applications.
- Cable plugs and jacks for armored cables.

Our C series product line is still growing, so please call if you don't see what you need.

C Configurations

Straight Cable Plugs	35	Dummy Receptacles	37
Right Angle Cable Plugs	35	Panel Plug Receptacles.....	38
Straight Cable Jacks	36	Bulkhead Jack Receptacles	38
Bulkhead Cable Jacks	36	Dust Caps.....	39
Panel Cable Jacks.....	37	In-Series Adapters	39
Panel Jack Receptacles (square flange)	37		

C Specifications*

Jack Interface**

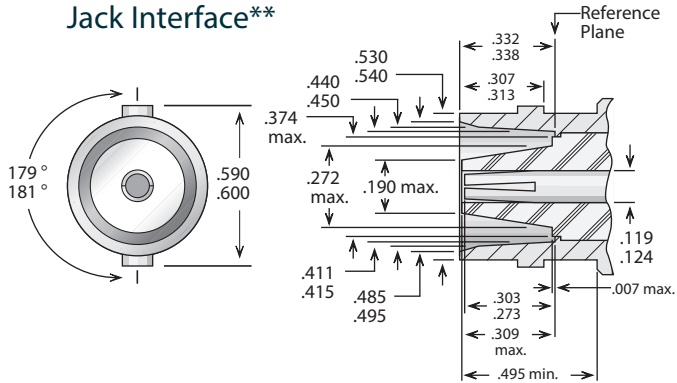

Electrical:

Nominal Impedance: 50 ohms.
 Frequency Range: DC-11 GHz (standard);
 DC-2 GHz (high-voltage).
 Voltage Rating: 1,000 volts RMS (standard);
 3,000 volts RMS (high-voltage).
 Dielectric Withstanding Voltage: 3,000 VRMS.
 Insulation Resistance: 5,000 megohms.

Materials/Finishes:

Insulators: Teflon per ASTM D1710.
 Male Contacts: Brass per ASTM-B-16.
 Female Contacts: Beryllium Copper per
 ASTM-B-196.

Contact Plating: Silver - ASTM B700
 Gold - MIL-DTL-45204.

Gaskets: Silicone rubber per ZZ-R-765,
 Class II, Grade 50.

Other Metal Parts: Brass per ASTM B16,

Plated: Silver - ASTM B700
 Nickel - AMS-QQ-N-290.

Plug Interface**

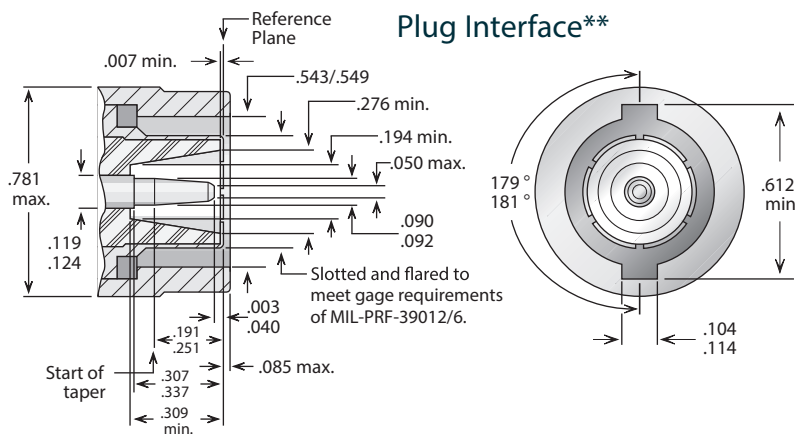

All other specifications are in accordance with the latest issues of MIL-PRF-39012, or MIL-A-55339, or other applicable MIL specifications, and interfaces are in accordance with MIL-STD-348.

*These specifications are typical and may not apply to all connectors. Detailed specifications for individual connectors are available on request.

**Some proportions altered to illustrate detail.

Straight Plug - Military Clamp For Flexible Cable

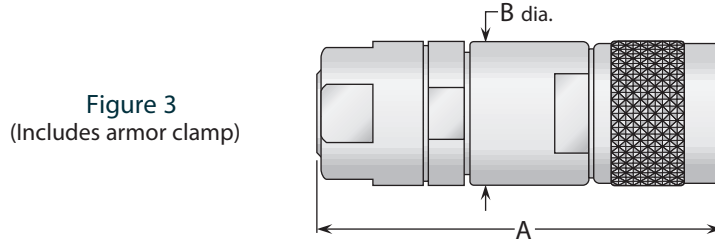
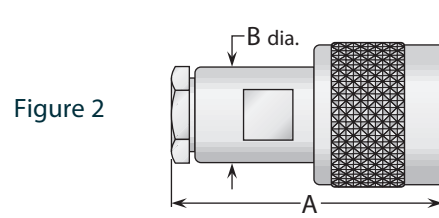
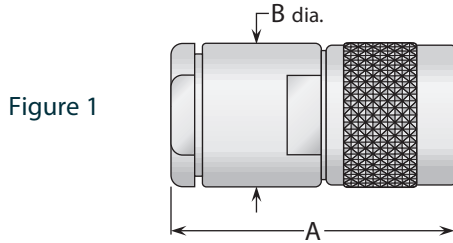

Cable Group	Figure	Dimensions		Plating		Delta P/N	Assembly Procedure/ Trim Code
		A	B	Body	Contact		
1	1	1.50	.750	Nickel	Silver	UG-626B/U	A/20
2,3	1	1.50	.750	Nickel	Silver	UG-573B/U	A/20
2,3	1	1.72	.750	Nickel	Silver	UG-628A/U *	A/21
2,3	1	1.50	.750	Nickel	Silver (C)	1401004N001-000	A/01
5,6	2	1.36	.500	Nickel	Silver	UG-709B/U	A/13
5,6	2	1.36	.500	Nickel	Silver (C)	1401015N001-000	A/02
7	2	1.36	.500	Nickel	Silver	UG-627B/U	A/22
15	3	2.13	.750	Nickel	Silver	UG-943B/U	D/04
16	1	1.63	.880	Nickel	Silver	UG-707A/U	A/23

* High-voltage type.

Right Angle Plug - Military Clamp For Flexible Cable

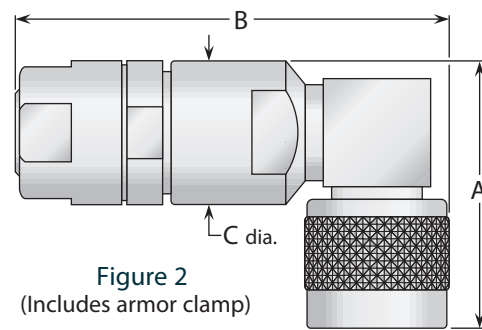
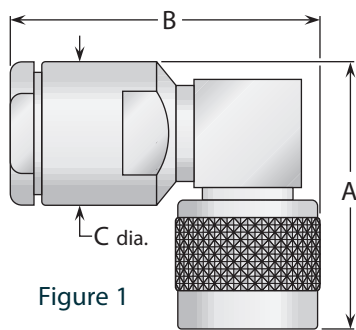

Cable Group	Figure	Dimensions			Plating		Delta P/N	Assembly Procedure/ Trim Code
		A	B	C	Body	Contact		
2,3	1	1.35	1.62	.750	Nickel	Gold	UG-710B/U	A/07
2,3	1	1.35	1.62	.750	Nickel	Silver (C)	1404004N001-000	A/01
15	2	1.35	2.31	.750	Nickel	Silver	UG-945B/U	D/01
16	1	1.41	1.78	.880	Nickel	Silver	1404007N000-000	A/24

- See page 209 for cable groups.
- Assembly procedures start on page 210.
- (C) in contact plating column indicates captive contact.
- See page 6 for alternate body plating information.

Straight Jack - Military Clamp For Flexible Cable

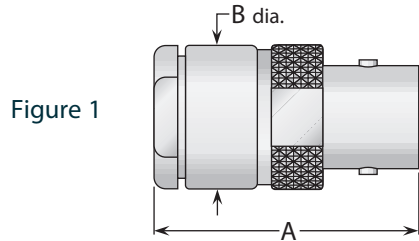
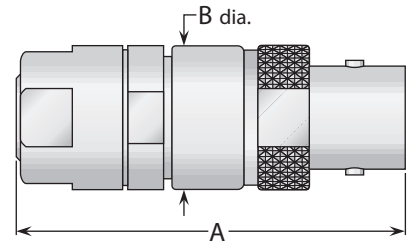

Figure 2
(Includes armor clamp)



Cable Group	Figure	Dimensions		Plating		Delta P/N	Assembly Procedure/ Trim Code
		A	B	Body	Contact		
1	1	1.41	.750	Nickel	Silver	UG-633A/U	A/20
2, 3	1	1.41	.750	Nickel	Silver	UG-572A/U	A/20
2, 3	1	1.41	.750	Nickel	Silver (C)	1408004N001-000	A/01
15	2	2.00	.750	Nickel	Silver	UG-944A/U	D/04

Bulkhead Jack - Military Clamp For Flexible Cable

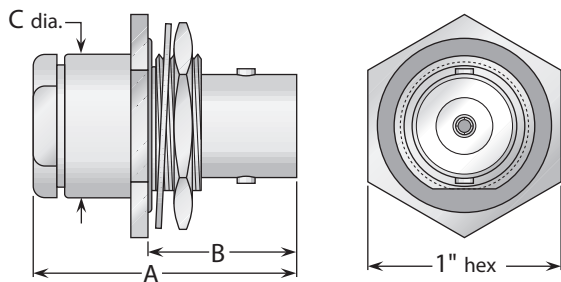

Figure 1
(Rear mount)

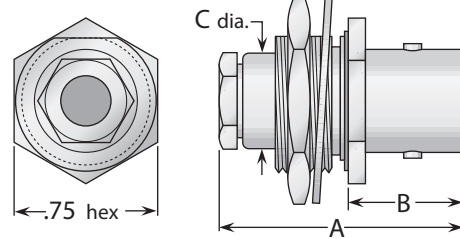

Figure 2
(Front mount)

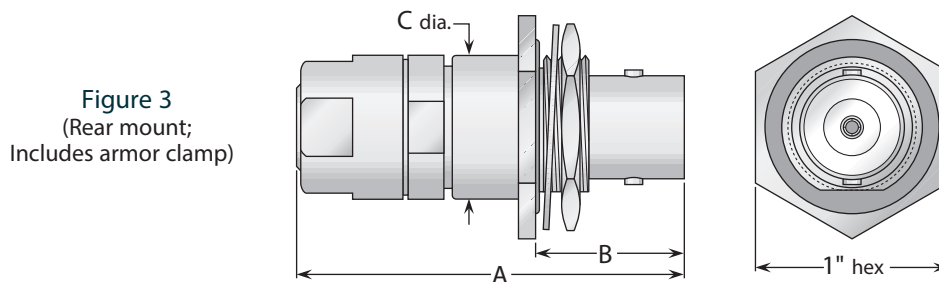

Figure 3
(Rear mount;
Includes armor clamp)

Cable Group	Fig.	Dimensions			Mounting Figure	Max. Panel	Plating		Delta P/N	Assembly Procedure/ Trim Code
		A	B	C			Body	Contact		
1	1	1.41	.750	.750	51	.125	Nickel	Silver	UG-630A/U	A/20
2, 3	1	1.41	.750	.750	51	.125	Nickel	Silver	UG-570A/U	A/20
2, 3	1	1.72	.750	.750	51	.125	Nickel	Silver	UG-632A/U *	A/21
2, 3	1	1.41	.750	.750	51	.125	Nickel	Silver (C)	1416004N511-000	A/01
5, 6	2	1.25	.590	.500	54	.190	Nickel	Silver	UG-704B/U	A/25
7	2	1.25	.590	.500	54	.190	Nickel	Silver	UG-631A/U	A/22
15	3	2.00	.750	.750	51	.125	Nickel	Silver	UG-937A/U	D/04

* High-voltage type.

- See page 209 for cable groups.
- Assembly procedures start on page 210.
- See page 208 for mounting dimensions.
- (C) in contact plating column indicates captive contact.
- See page 6 for alternate body plating information.

Panel Jack - Military Clamp For Flexible Cable

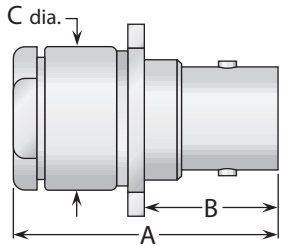

Figure 1

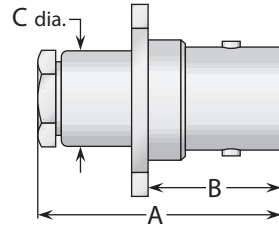
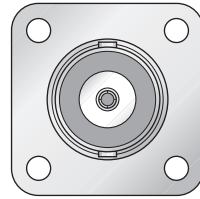

Figure 2

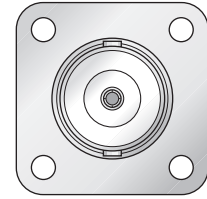
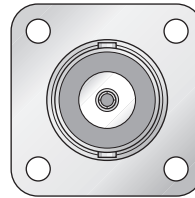
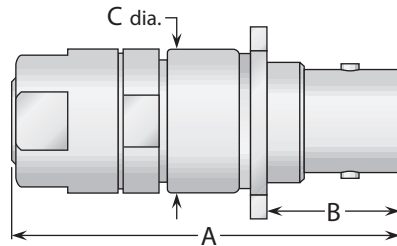

Figure 3
(Includes armor clamp)



Cable Group	Fig.	Dimensions			Mounting Figure	Plating		Delta P/N	Assembly Procedure/Trim Code
		A	B	C		Body	Contact		
1	1	1.41	.690	.750	26	Nickel	Silver	UG-629A/U	A/20
2, 3	1	1.41	.690	.750	26	Nickel	Silver	UG-571A/U	A/20
2, 3	1	1.41	.690	.750	26	Nickel	Silver (C)	1411004N261-000	A/01
5, 6	2	1.28	.670	.500	26	Nickel	Silver	1411015N260-000	A/25
15	3	2.00	.690	.750	26	Nickel	Silver	UG-938A/U	D/04

Panel Jack Receptacles - Square Flange

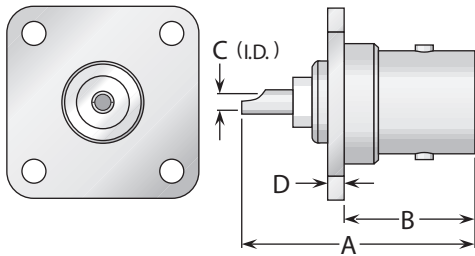

Figure 1
(Solder pot contact)

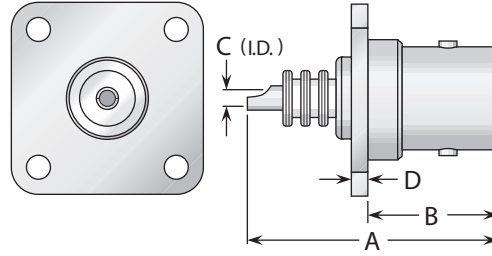

Figure 2
(Solder pot contact)

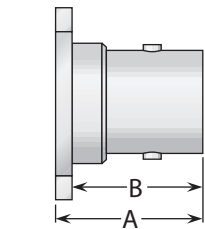

Figure 3
(Dummy receptacle)

Figure	Dimensions				Mounting Figure	Plating		Delta P/N
	A	B	C	D		Body	Contact	
1	1.06	.670	.106	.080	26	Nickel	Silver (C)	UG-568/U
1	1.06	.670	.106	.080	33	Nickel	Silver (C)	1413000N331-000
2	1.31	.670	.106	.080	33	Nickel	Gold (C)	1413000N331-001 *
3	.740	.080	—	—	33	Nickel	—	1463000N330-000

* High-voltage type.

See page 209 for cable groups. • Assembly procedures start on page 210. • See page 208 for mounting dimensions.
(C) in contact plating column indicates captive contact. • See page 6 for alternate body plating information.

Panel Plug Receptacle -Square Flange

Figure 1
(Solder pot contact)

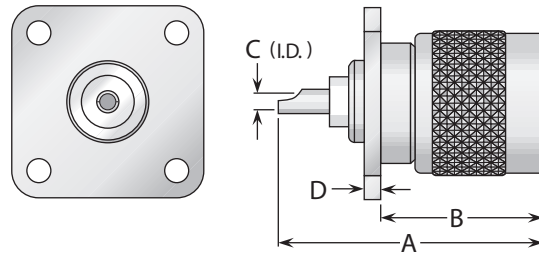

Figure	Dimensions				Mounting Figure	Plating		Delta P/N
	A	B	C	D		Body	Contact	
1	1.25	.830	.106	.080	33	Nickel	Silver (C)	142300N331-000

Bulkhead Jack Receptacles

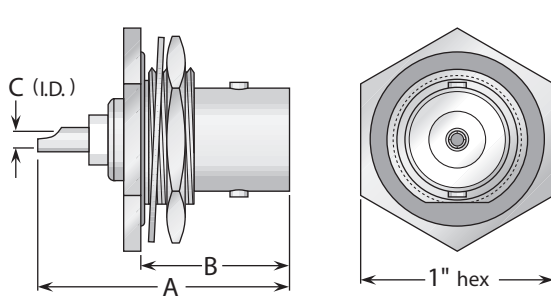

Figure 1
(Rear mount, with mounting gasket)

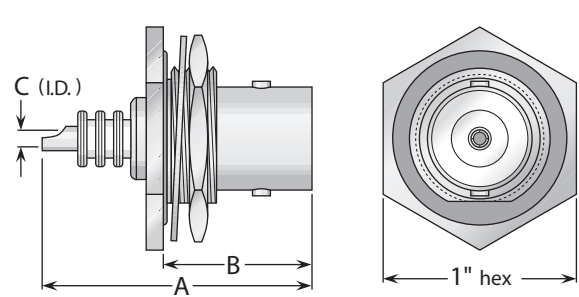

Figure 2
(Rear mount, with mounting gasket)

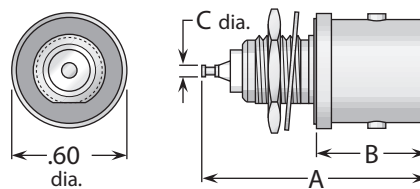

Figure 3
(Front mount, with mounting gasket)

Figure	Dimensions			Max. Panel	Mounting Figure	Plating		Delta P/N
	A	B	C			Body	Contact	
1	1.06	.750	.106	.125	51	Nickel	Silver (C)	UG-569A/U
2	1.32	.750	.106	.125	51	Nickel	Silver (C)	UG-634/U *
3	1.10	.580	.061	.125	65	Nickel	Silver (C)	UG-706A/U

* High-voltage type.

- See page 208 for mounting dimensions.
- (C) in contact plating column indicates captive contact.
- See page 6 for alternate body plating information.

Bulkhead Jack - Jack Adapter

Figure 1
(Connects two plugs)

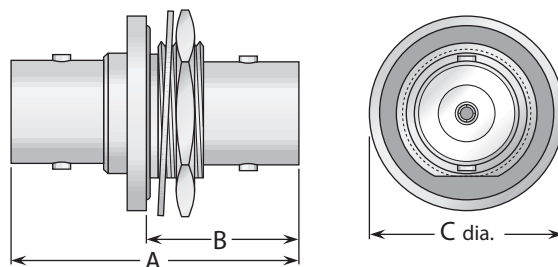

Figure	Dimensions			Max. Panel	Mounting Figure	Plating		Delta P/N
	A	B	C			Body	Contact	
1	1.50	.855	1.00	.200	51	Nickel	Silver (C)	UG-1138A/U *
1	1.50	.855	1.00	.200	51	Nickel	Silver (C)	1426000N511-000

Straight, Right Angle & Tee Adapters

Figure 1
(Straight jack-jack;
connects two plugs)

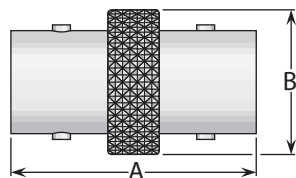

Figure 2
(Straight plug-plug;
connects two jacks)

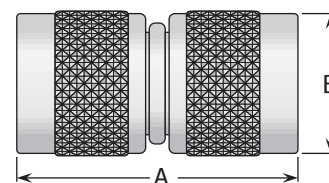

Figure 3
(Right angle jack-plug;
connects one plug
and one jack)

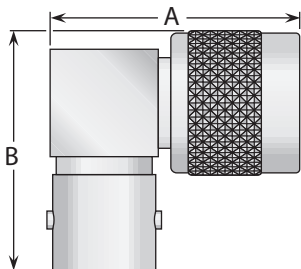

Figure 4
(Tee jack-plug-jack;
connects two plugs
and one jack)

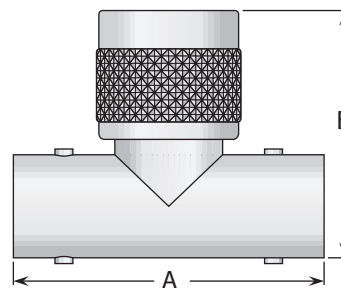

Figure	Dimensions		Plating		Delta P/N
	A	B	Body	Contact	
1	1.28	.750	Nickel	Silver (C)	UG-643/U
2	1.45	.750	Nickel	Silver (C)	UG-642A/U
3	1.25	1.16	Nickel	Silver (C)	UG-567A/U
4	1.52	1.28	Nickel	Silver (C)	UG-566A/U

Dust Caps

Figure 1

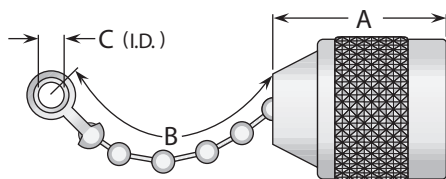

Figure 2

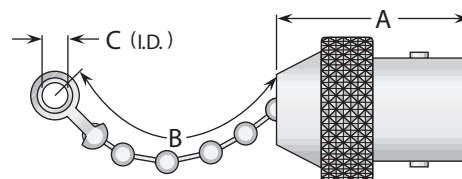

Figure	Dimensions			Features	Plating		Delta P/N
	A	B	C		Body	Contact	
1	.910	2.50	.144	Bead chain	Nickel	—	MX-1142A/U
2	.890	3.50	.144	Bead chain	Nickel	—	MX-1143A/U

*Hermetically sealed. • See page 208 for mounting dimensions.
(C) in contact plating column indicates captive contact. • See page 6 for alternate body plating information.

General Description

Delta G874 connectors are hermaphroditic, 50 Ω impedance connectors with an interface compatible with all General Radio GR874 series connectors. This slide-on interface has been a standard for many years on a wide variety of test equipment, due to its good electrical characteristics and ease of mating.

All connectors in this series are also available with a locking interface for added mechanical security where needed. Locking and non-locking interfaces are intermateable.

Specifications

Electrical:

Nominal Impedance: 50 ohms.
Frequency Range: DC–8.5 GHz, or as noted.

Materials / Finishes:

Insulators: Teflon per ASTM D1710.
Contacts: Beryllium Copper per ASTM B196.
Contact Plating: Albaloy (see page 4 for details)

Gaskets: Silicone rubber per ZZ-R-765, Class II, Grade 50.
Other Metal Parts: Brass per ASTM B16, Nickel plated -AMS-QQ-N-290, or Albaloy plated.

Interface Kit

Figure 1
(Non-locking)

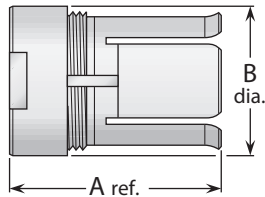

Figure 2
(Locking)

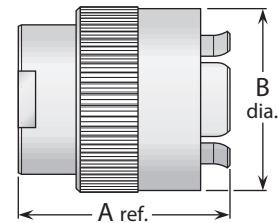

Figure	Dimensions		Plating	Delta P/N
	A	B		
1	1.09	.810	See specifications	2801000N000-001
2	1.12	.990	See specifications	2801000N000-000

Cable Connector - Crimp Type For Flexible Cable

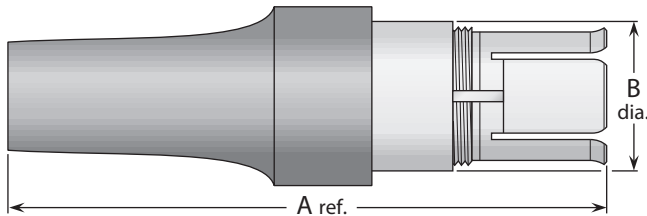

Figure 1
(Non-locking)

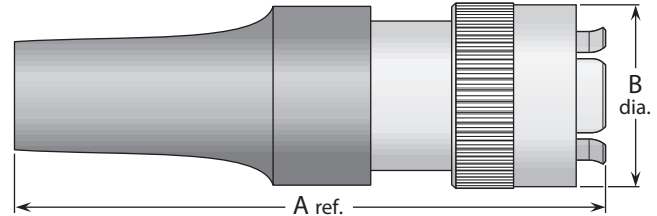
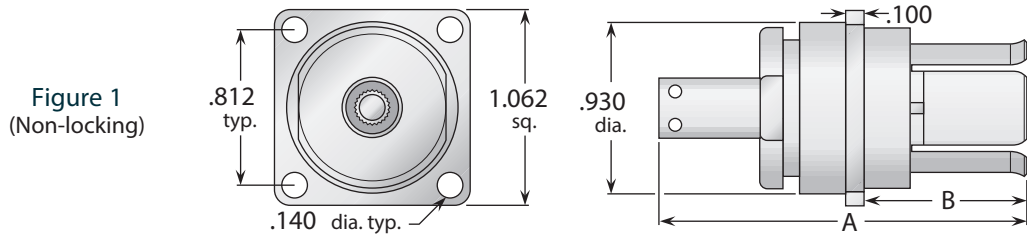

Figure 2
(Locking)

Cable Group	Figure	Dimensions		Plating	Delta P/N	Assembly Procedure/ Trim Code
		A	B			
2, 3	1	3.27	.810	See specifications	2802002F001-001	***
2, 3	2	3.27	.990	See specifications	2802002F001-000	***
5, 6	1	3.27	.810	See specifications	2802012N001-001	***
5, 6	2	3.27	.990	See specifications	2802012N001-000	***
7	1	3.27	.810	See specifications	2802021N001-001	***
7	2	3.27	.990	See specifications	2802021N001-000	***
9	1	3.27	.810	See specifications	2802037N001-001	***
9	2	3.27	.990	See specifications	2802037N001-000	***

See page 209 for cable groups. • ***Contact factory for cable assembly instructions. • Change N in part numbers to Q for Albaloy body.

Panel Mounted Connector - Crimp Type For Flexible Cable



Cable Group	Figure	Dimensions		Plating	Delta P/N	Assembly Procedure/ Trim Code
		A	B			
2	1	1.80	.900	See specifications	2811002N911-000	***
3	1	1.80	.900	See specifications	2811004N911-000	***
5	1	1.86	.900	See specifications	2811017N911-000	***
6	1	2.10	.900	See specifications	2811015N911-000	***
7	1	1.83	.900	See specifications	2811021N911-000	***

Adapters Within Series

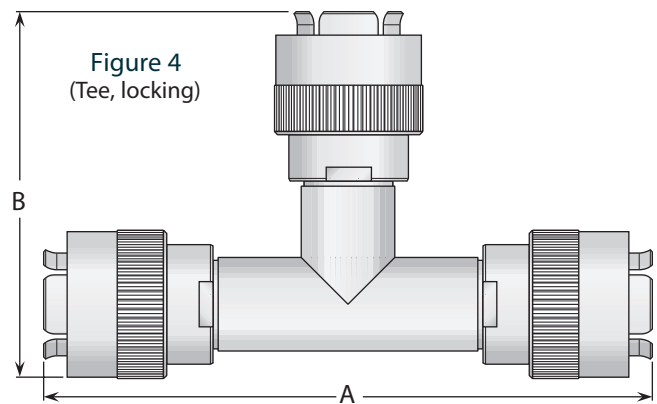
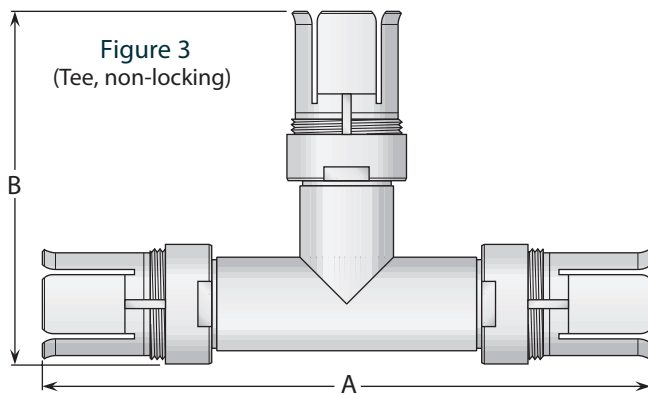
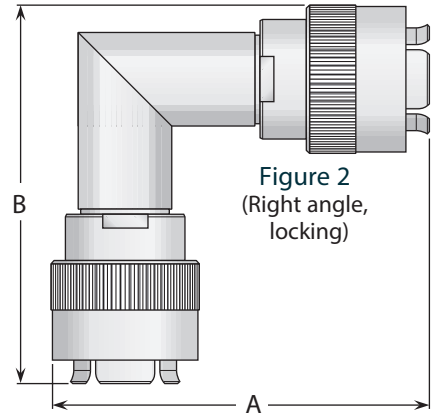
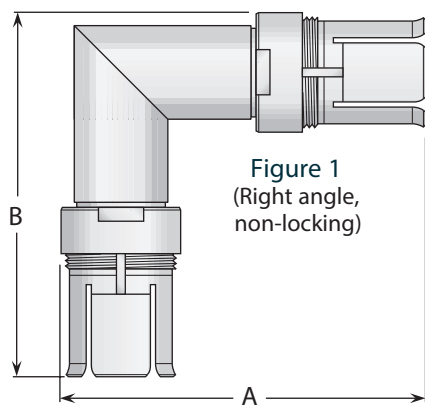
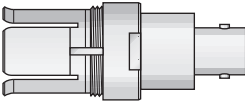
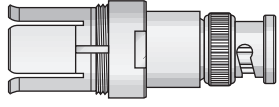
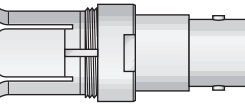
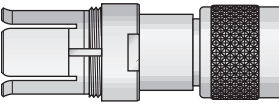
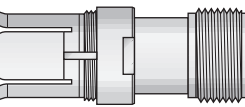
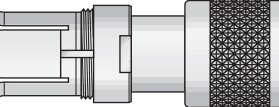
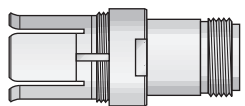
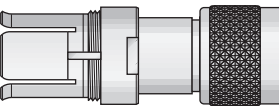
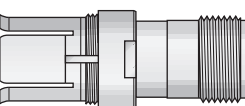
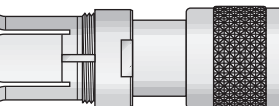
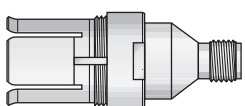
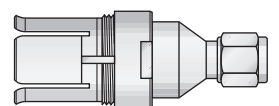
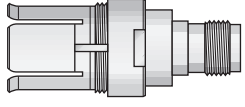
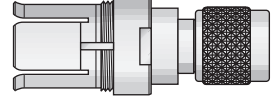
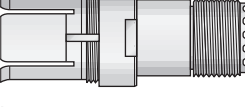
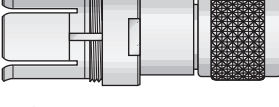

Figure	Dimensions		Plating	Delta P/N
	A	B		
1	2.06	2.06	See specifications	2835000N000-001
2	2.15	2.15	See specifications	2835000N000-000
3	3.38	2.09	See specifications	2838000N000-001
4	3.38	2.19	See specifications	2838000N000-000

See page 209 for cable groups. • ***Contact factory for cable assembly instructions.

Adapters Between Series - Non-Locking G874 To:

<p>BNC Jack</p>  <p>Delta P/N 2234000N000-031</p>	<p>Length: 1.66 Nominal Impedance: 50 Ω Frequency Range: DC -4.0 GHz Operating Voltage: 500 max.</p>	<p>BNC Plug</p>  <p>Delta P/N 2234000N000-014</p>	<p>Length: 1.81 Nominal Impedance: 50 Ω Frequency Range: DC -4.0 GHz Operating Voltage: 500 max.</p>
<p>C Jack</p>  <p>Delta P/N 2234000N000-032</p>	<p>Length: 1.91 Nominal Impedance: 50 Ω Frequency Range: DC -8.5 GHz Operating Voltage: 1000 max.</p>	<p>C Plug</p>  <p>Delta P/N 2234000N000-033</p>	<p>Length: 2.05 Nominal Impedance: 50 Ω Frequency Range: DC -8.5 GHz Operating Voltage: 1000 max.</p>
<p>HN Jack</p>  <p>Delta P/N 2234000N000-036</p>	<p>Length: 1.88 Nominal Impedance: 50 Ω Frequency Range: DC -8.5 GHz Operating Voltage: 1500 max.</p>	<p>HN Plug</p>  <p>Delta P/N 2234000N000-037</p>	<p>Length: 2.28 Nominal Impedance: 50 Ω Frequency Range: DC -8.5 GHz Operating Voltage: 1500 max.</p>
<p>N Jack</p>  <p>Delta P/N 2234000N000-018</p>	<p>Length: 1.63 Nominal Impedance: 50 Ω Frequency Range: DC -8.5 GHz Operating Voltage: 1000 max.</p>	<p>N Plug</p>  <p>Delta P/N 2234000N000-017</p>	<p>Length: 2.01 Nominal Impedance: 50 Ω Frequency Range: DC -8.5 GHz Operating Voltage: 1000 max.</p>
<p>SC Jack</p>  <p>Delta P/N 2234000N000-051</p>	<p>Length: 1.91 Nominal Impedance: 50 Ω Frequency Range: DC -8.5 GHz Operating Voltage: 1000 max.</p>	<p>SC Plug</p>  <p>Delta P/N 2234000N000-052</p>	<p>Length: 2.05 Nominal Impedance: 50 Ω Frequency Range: DC -8.5 GHz Operating Voltage: 1000 max.</p>
<p>SMA Jack</p>  <p>Delta P/N 2234000N000-041</p>	<p>Length: 1.68 Nominal Impedance: 50 Ω Frequency Range: DC -8.5 GHz Operating Voltage: 335 max.</p>	<p>SMA Plug</p>  <p>Delta P/N 2234000N000-042</p>	<p>Length: 1.84 Nominal Impedance: 50 Ω Frequency Range: DC -8.5 GHz Operating Voltage: 335 max.</p>
<p>TNC Jack</p>  <p>Delta P/N 2234000N000-023</p>	<p>Length: 1.66 Nominal Impedance: 50 Ω Frequency Range: DC -8.5 GHz Operating Voltage: 500 max.</p>	<p>TNC Plug</p>  <p>Delta P/N 2234000N000-045</p>	<p>Length: 1.87 Nominal Impedance: 50 Ω Frequency Range: DC -8.5 GHz Operating Voltage: 500 max.</p>
<p>UHF Jack</p>  <p>Delta P/N 2234000N000-048</p>	<p>Length: 1.80 Nominal Impedance: Nonconstant Frequency Range: UHF Range Operating Voltage: 500 max.</p>	<p>UHF Plug</p>  <p>Delta P/N 2234000N000-029</p>	<p>Length: 2.06 Nominal Impedance: Nonconstant Frequency Range: UHF Range Operating Voltage: 500 max.</p>

Adapters Between Series - Locking G874 To:

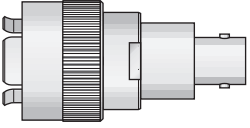
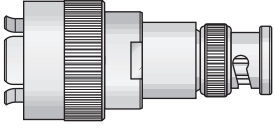
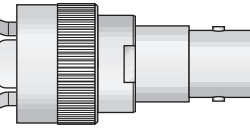
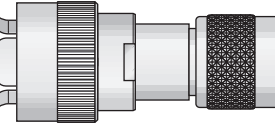
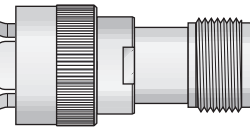
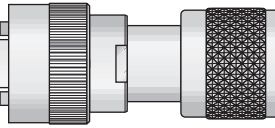
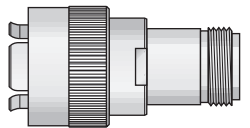
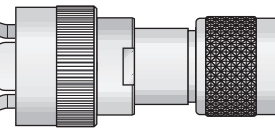
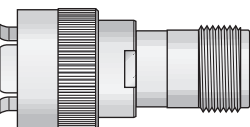
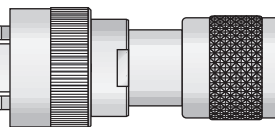
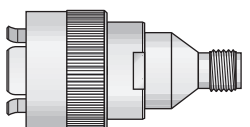
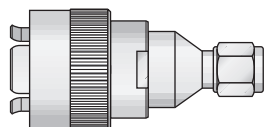
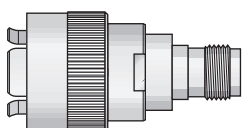
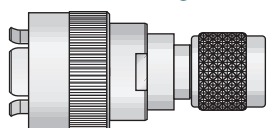
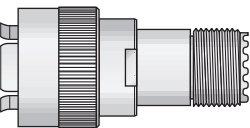
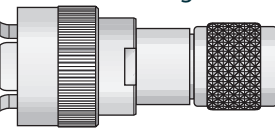
<p>BNC Jack</p>  <p>Delta P/N 2234000N000-015</p>	<p>Length: 1.66 Nominal Impedance: 50Ω Frequency Range: DC -4.0 GHz Operating Voltage: 500 max.</p>	<p>BNC Plug</p>  <p>Delta P/N 2234000N000-030</p>	<p>Length: 1.81 Nominal Impedance: 50Ω Frequency Range: DC -4.0 GHz Operating Voltage: 500 max.</p>
<p>C Jack</p>  <p>Delta P/N 2234000N000-034</p>	<p>Length: 1.91 Nominal Impedance: 50Ω Frequency Range: DC -8.5 GHz Operating Voltage: 1000 max.</p>	<p>C Plug</p>  <p>Delta P/N 2234000N000-035</p>	<p>Length: 2.05 Nominal Impedance: 50Ω Frequency Range: DC -8.5 GHz Operating Voltage: 1000 max.</p>
<p>HN Jack</p>  <p>Delta P/N 2234000N000-038</p>	<p>Length: 1.88 Nominal Impedance: 50Ω Frequency Range: DC -8.5 GHz Operating Voltage: 1500 max.</p>	<p>HN Plug</p>  <p>Delta P/N 2234000N000-039</p>	<p>Length: 2.28 Nominal Impedance: 50Ω Frequency Range: DC -8.5 GHz Operating Voltage: 1500 max.</p>
<p>N Jack</p>  <p>Delta P/N 2234000N000-040</p>	<p>Length: 1.63 Nominal Impedance: 50Ω Frequency Range: DC -8.5 GHz Operating Voltage: 1000 max.</p>	<p>N Plug</p>  <p>Delta P/N 2234000N000-024</p>	<p>Length: 2.01 Nominal Impedance: 50Ω Frequency Range: DC -8.5 GHz Operating Voltage: 1000 max.</p>
<p>SC Jack</p>  <p>Delta P/N 2234000N000-053</p>	<p>Length: 1.91 Nominal Impedance: 50Ω Frequency Range: DC -8.5 GHz Operating Voltage: 1000 max.</p>	<p>SC Plug</p>  <p>Delta P/N 2234000N000-054</p>	<p>Length: 2.05 Nominal Impedance: 50Ω Frequency Range: DC -8.5 GHz Operating Voltage: 1000 max.</p>
<p>SMA Jack</p>  <p>Delta P/N 2234000N000-043</p>	<p>Length: 1.68 Nominal Impedance: 50Ω Frequency Range: DC -8.5 GHz Operating Voltage: 335 max.</p>	<p>SMA Plug</p>  <p>Delta P/N 2234000N000-044</p>	<p>Length: 1.84 Nominal Impedance: 50Ω Frequency Range: DC -8.5 GHz Operating Voltage: 335 max.</p>
<p>TNC Jack</p>  <p>Delta P/N 2234000N000-046</p>	<p>Length: 1.66 Nominal Impedance: 50Ω Frequency Range: DC -8.5 GHz Operating Voltage: 500 max.</p>	<p>TNC Plug</p>  <p>Delta P/N 2234000N000-047</p>	<p>Length: 1.87 Nominal Impedance: 50Ω Frequency Range: DC -8.5 GHz Operating Voltage: 500 max.</p>
<p>UHF Jack</p>  <p>Delta P/N 2234000N000-049</p>	<p>Length: 1.80 Nominal Impedance: Nonconstant Frequency Range: UHF Range Operating Voltage: 500 max.</p>	<p>UHF Plug</p>  <p>Delta P/N 2234000N000-050</p>	<p>Length: 2.06 Nominal Impedance: Nonconstant Frequency Range: UHF Range Operating Voltage: 500 max.</p>

General Description & Specifications

Delta GHV connectors are high voltage, 50 Ω impedance connectors with 3/4"-20 threaded coupling. They are best suited for use with RG-8A/U cable, and feature deeply recessed contacts, counterbored insulators, and retractable plug coupling nuts for high power handling capability and safety.

Electrical:

Nominal Impedance: 50 ohms.
 Frequency Range: DC-1 GHz.
 Voltage Rating: 25 KV DC (sea level).
 Insulation Resistance: 5,000 megohms.

Materials/Finishes:

Insulators: Teflon per ASTM D1710.
 Male Contacts: Brass per ASTM B16.
 Female Contacts: Beryllium Copper per ASTM B196.
 Contact Plating : Gold -MIL-DTL-45204.
 Gaskets: Silicone rubber per ZZ-R-765, Class II, Grade 50.
 Other Metal Parts: Brass per ASTM B16, Silver plated per ASTM B700.

GHV Connectors

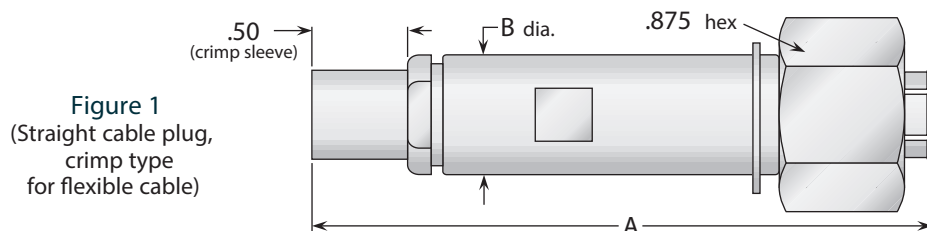

Figure 1
 (Straight cable plug,
 crimp type
 for flexible cable)

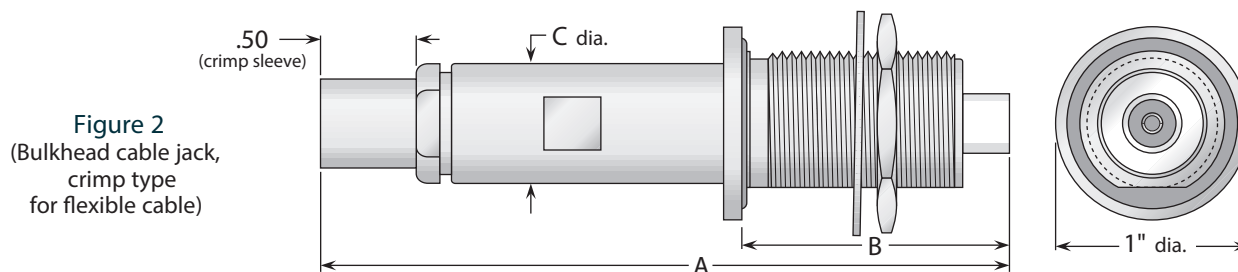
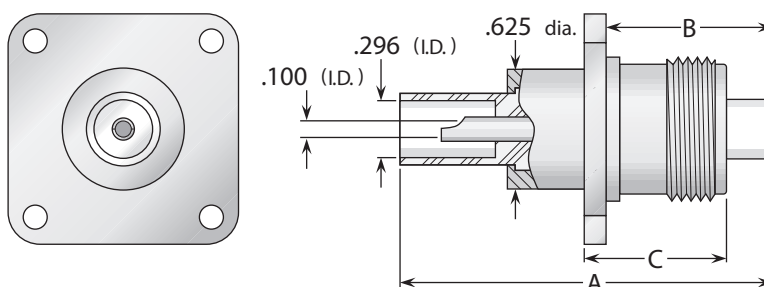

Figure 2
 (Bulkhead cable jack,
 crimp type
 for flexible cable)

Figure 3
 (Panel jack receptacle,
 square flange)



Cable Group	Fig.	Dimensions			Mounting Figure	Max. Panel	Plating		Delta P/N	Assembly Procedure/Trim Code
		A	B	C			Body	Contact		
2	1	3.19	.625	—	—	—	Silver	Gold	1502002A000-000	***
3	1	3.19	.625	—	—	—	Silver	Gold	1502004A000-000	***
5	1	3.19	.625	—	—	—	Silver	Gold	1502017A000-000	***
2	2	3.63	1.66	.625	51	.750	Silver	Gold	1516002A510-000	***
3	2	3.63	1.66	.625	51	.750	Silver	Gold	1516004A510-001	***
—	3	1.94	.880	.750	39	—	Silver	Gold (C)	1513000A391-000	—

See page 209 for cable groups. • (C) in contact plating column indicates captive contact.
 See page 208 for mounting dimensions. • ***Contact factory for cable assembly instructions.

General Description

Delta HN series connectors are medium-size, 50 Ω impedance connectors with 3/4-20 threaded coupling and good power handling capability. They are best suited for use with cables in the range of .350" to .450" diameter, but are available for other cables from .200" to over 1" diameter. Our extensive line of HN receptacles includes configurations for virtually any packaging requirement, and we can supply any adapter or accessory you need to complete your system design. Adapters between HN and other series are shown starting on page 176. Our HN series product line is still growing, so please call if you don't see what you need.

HN Configurations

Straight Cable Plugs	46	Panel Plug Receptacles.....	48
Right Angle Cable Plugs	46	Bulkhead Jack Receptacles	48
Straight Cable Jacks	47	Dummy Receptacles	48
Panel Cable Jacks	47	Dust Caps.....	48
Panel Jack Receptacles (square flange)	48	In-Series Adapters	49

HN Specifications*

Plug Interface**

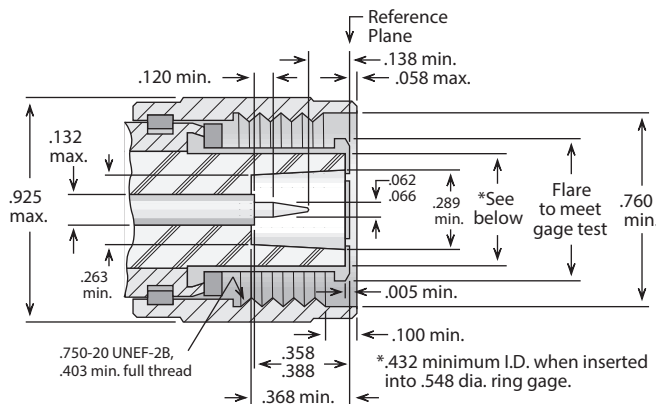

Jack Interface**

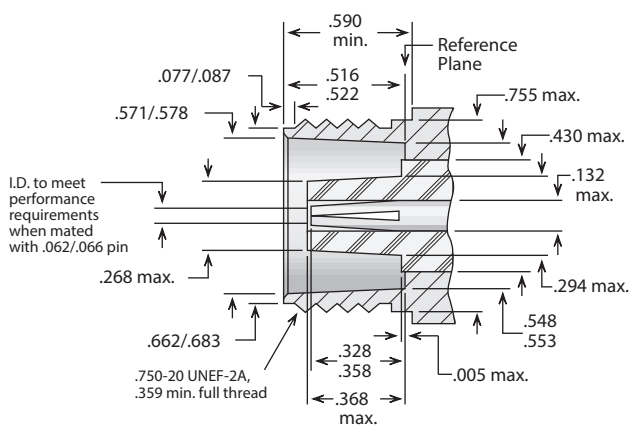

**Some proportions altered to illustrate detail.

Electrical:

Nominal Impedance: 50 ohms.
 Frequency Range: DC-4 GHz.
 Voltage Rating: 1,500 volts RMS.
 Dielectric Withstanding Voltage: 5,000 VRMS.
 Insulation Resistance: 5,000 megohms.

Materials/Finishes:

Insulators: Teflon per ASTM D1710, or Rexolite per MIL-P-77.
 Male Contacts: Brass per ASTM B16.
 Female Contacts: Beryllium Copper per ASTM B196.
 Contact Plating: Silver per ASTM B700, or Gold per MIL-DTL-45204.
 Gaskets: Silicone rubber per ZZ-R-765, Class II, Grade 50.
 Other Metal Parts: Brass per ASTM B16, plated:
 Silver - ASTM B700, or
 Nickel - AMS-QQ-N-290.

All other specifications are in accordance with the latest issues of MIL-PRF-39012, or MIL-C-3643, or other applicable MIL specifications, and interfaces are in accordance with MIL-STD-348.

*These specifications are typical and may not apply to all connectors. Detailed specifications for individual connectors are available on request.

Straight Plug - Military Clamp For Flexible Cable

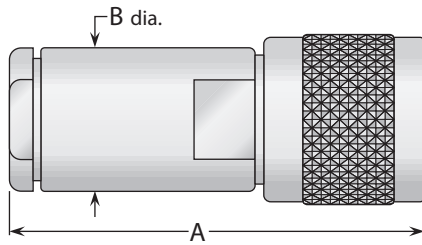

Figure 1

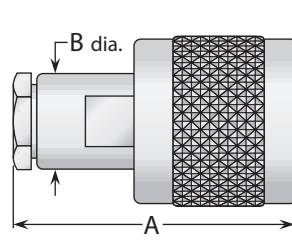

Figure 2

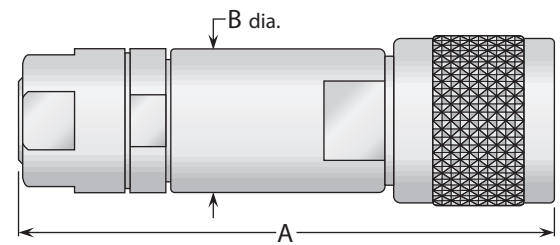

Figure 3 (Includes armor clamp)

Cable Group	Figure	Dimensions		Plating		Delta P/N	Assembly Procedure/Trim Code
		A	B	Body	Contact		
2, 3	1	2.38	.690	Nickel	Silver	UG-59B/U	***
2, 3	1	2.25	.750	Nickel	Silver	UG-59E/U	A/26
2, 3	1	2.81	.690	Nickel	Silver (C)	UG-1213/U	***
4	1	2.23	.750	Nickel	Silver (C)	1601079N001-000	***
5, 6	2	1.50	.500	Nickel	Silver	1601015N000-000	A/17
15	3	2.84	.750	Nickel	Silver	UG-925B/U	D/05
16	1	2.41	.880	Nickel	Silver	UG-494B/U	A/27
17	1	2.59	1.31	Nickel	Silver	UG-495D/U	A/28
17	3	3.53	1.31	Nickel	Silver	UG-1148/U	***
20	3	3.20	1.31	Nickel	Silver	UG-926A/U	D/06

Right Angle Plug - Military Clamp For Flexible Cable

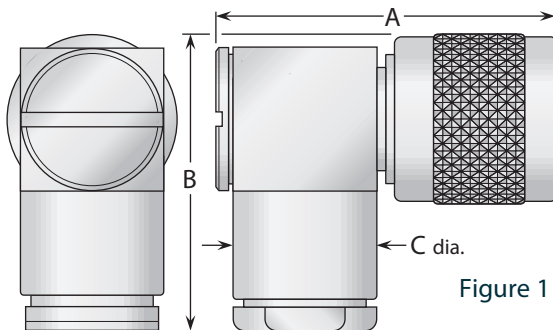

Figure 1

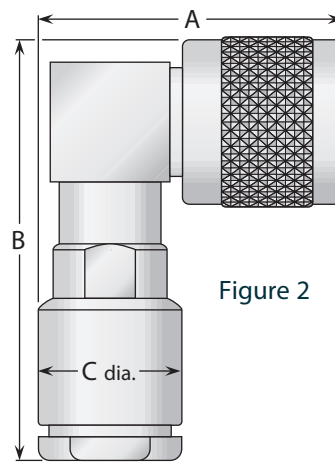

Figure 2

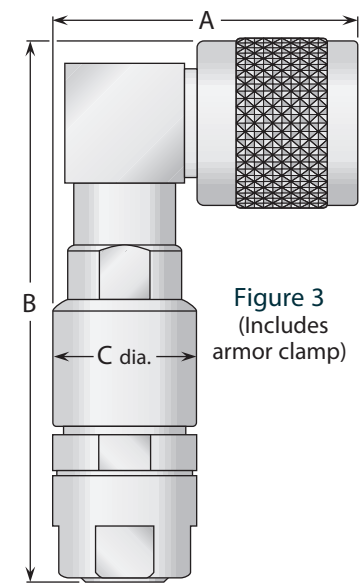

Figure 3 (Includes armor clamp)

Cable Group	Figure	Dimensions			Plating		Delta P/N	Assembly Procedure/Trim Code
		A	B	C	Body	Contact		
2, 3	1	1.73	1.63	.750	Nickel	Silver (C)	1605004N001-002	A/29
2, 3	2	1.53	2.25	.690	Nickel	Silver (C)	1604004N001-000	***
2, 3	2	1.56	2.48	.750	Nickel	Silver	1604005N000-000	A/27
4	2	1.56	2.48	.750	Nickel	Silver (C)	1604079N001-001	***
15	3	1.56	3.05	.750	Nickel	Silver	1604006N000-000	D/05

See page 209 for cable groups. • Assembly procedures start on page 210. • ***Contact factory for cable assembly instructions.
(C) in contact plating column indicates captive contact. • See page 6 for alternate body plating information.

Straight Jack - Military Clamp For Flexible Cable

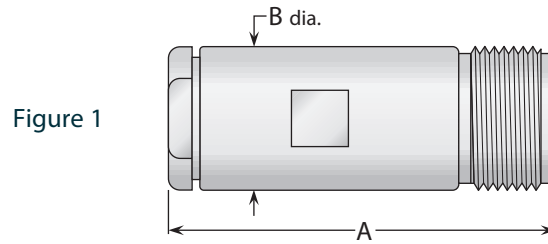
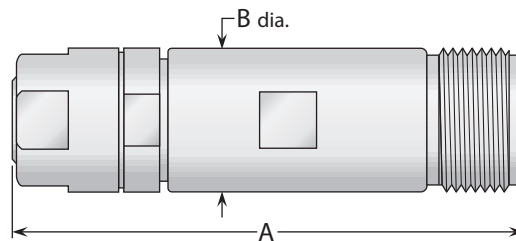

Figure 2
(Includes armor clamp)



Cable Group	Figure	Dimensions		Plating		Delta P/N	Assembly Procedure/ Trim Code
		A	B	Body	Contact		
2, 3	1	2.53	.690	Nickel	Silver	UG-60B/U	***
2, 3	1	2.03	.750	Nickel	Silver	UG-60E/U	A/26
2, 3	1	2.94	.690	Nickel	Silver (C)	UG-1214/U	***
15	2	2.63	.750	Nickel	Silver	UG-927B/U	D/05
17	1	2.53	1.31	Nickel	Silver	UG-333C/U	A/28

Panel Jack - Military Clamp For Flexible Cable

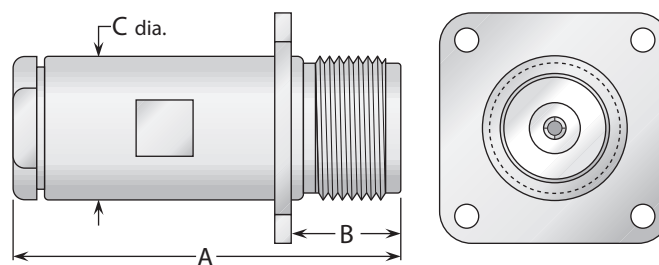

Figure 1

Cable Group	Fig.	Dimensions			Mounting Figure	Plating		Delta P/N	Assembly Procedure/ Trim Code
		A	B	C		Body	Contact		
2, 3	1	2.53	.590	.690	40	Nickel	Silver	UG-61B/U	***
2, 3	1	2.03	.590	.750	40	Nickel	Silver	UG-61E/U	A/26
2, 3	1	2.03	.590	.750	36	Nickel	Silver	UG-427C/U	A/26

See page 209 for cable groups. • Assembly procedures start on page 210.
 ***Contact factory for cable assembly instructions. • See page 208 for mounting dimensions.
 (C) in contact plating column indicates captive contact. • See page 6 for alternate body plating information.

Panel & Bulkhead Receptacles

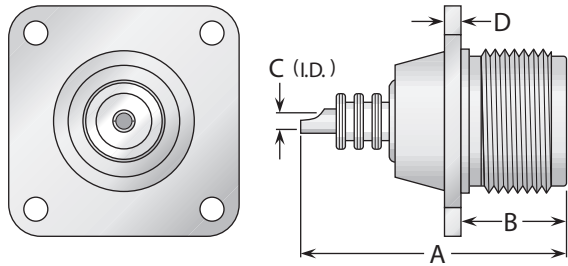

Figure 1
(Panel jack receptacle)

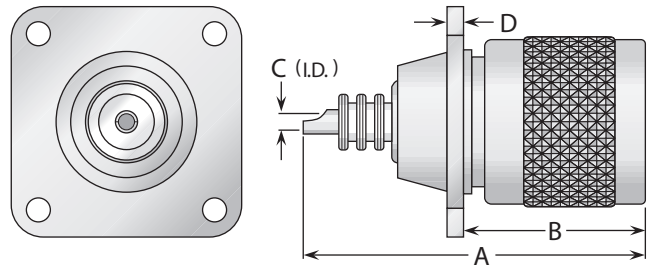

Figure 2
(Panel plug receptacle)

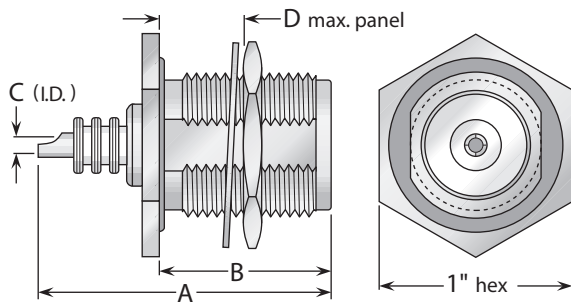

Figure 3
(Bulkhead jack receptacle)

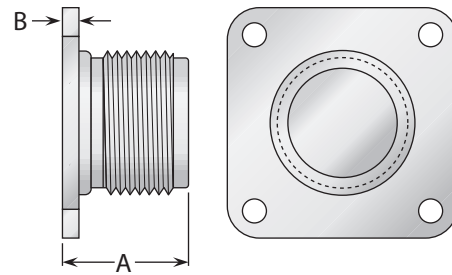

Figure 4
(Dummy receptacle)

Figure	Dimensions				Mounting Figure	Plating		Delta P/N
	A	B	C	D		Body	Contact	
1	1.50	.590	.106	.080	40	Nickel	Silver (C)	UG-496/U
2	1.88	.940	.106	.080	40	Nickel	Silver (C)	1623000N401-000
3	1.55	.890	.106	.250	69	Nickel	Silver (C)	1621000N691-000
4	.875	.125	—	—	34*	Nickel	—	1663000N340-000

* Except mounting holes are .120 diameter.

Dust Caps

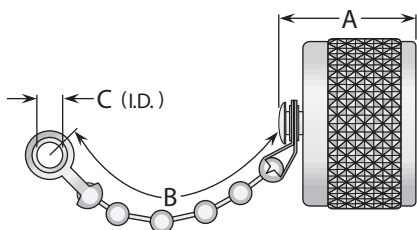

Figure 1

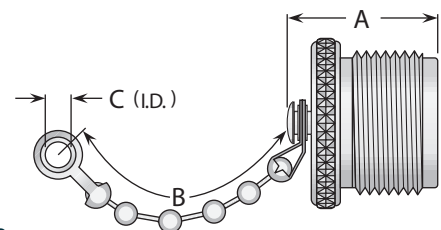
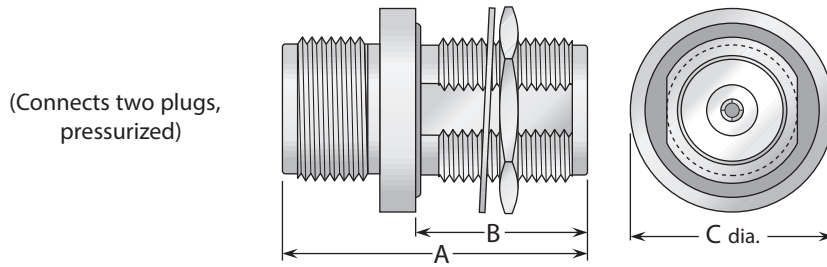

Figure 2

Figure	Dimensions			Features	Plating		Delta P/N
	A	B	C		Body	Contact	
1	.700	3.50	.144	Bead chain	Nickel	—	1632000N000-000
2	.700	3.50	.144	Bead chain	Nickel	—	1633000N000-000

- See page 208 for mounting dimensions.
- (C) in contact plating column indicates captive contact.
- See page 6 for alternate body plating information.
- Dust caps available with other chain styles and lengths.

Bulkhead Jack - Jack Adapter



Dimensions			Max. Panel	Mounting Figure	Plating		Delta P/N
A	B	C			Body	Contact	
1.94	1.06	1.06	.250	69	Nickel	Silver (C)	UG-1019A/U

Straight Adapters

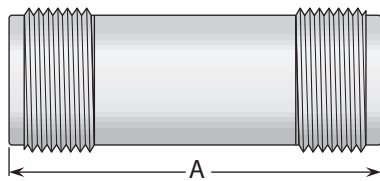

Figure 1
 (Straight jack-jack;
 connects two plugs)

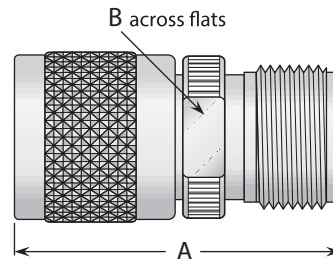

Figure 2
 (Straight plug-jack; connects one
 plug and one jack)

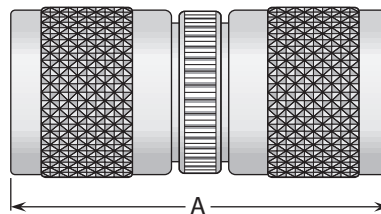

Figure 3
 (Straight plug-plug;
 connects two jacks)

Figure	Dimension		Plating		Delta P/N
	A	B	Body	Contact	
1	2.00	—	Nickel	Silver (C)	1628000N000-000
2	1.63	.750	Nickel	Silver (C)	1634000N001-000
3	1.94	—	Nickel	Silver (C)	1627000N000-000

- See page 208 for mounting dimensions.
- (C) in contact plating column indicates captive contact.
- See page 6 for alternate body plating information.

Right Angle & Tee Adapters

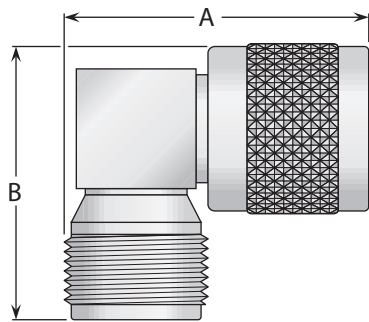

Figure 1
 (Right angle jack-plug; connects one plug and one jack)

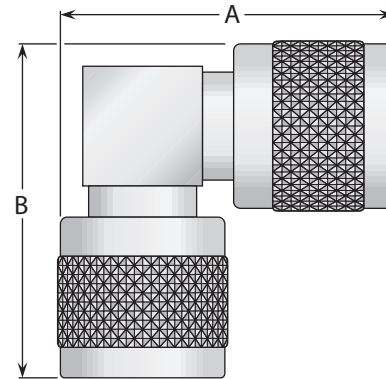

Figure 2
 (Right angle plug-plug; connects two jacks)

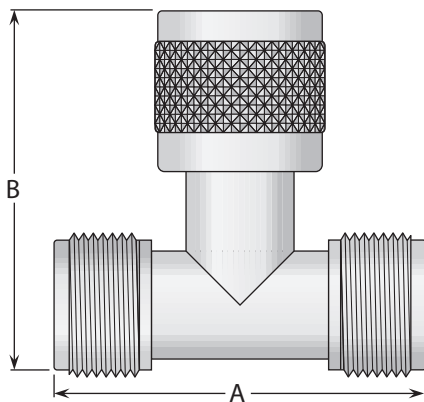

Figure 3
 (Tee jack-plug-jack; connects two plugs and one jack)

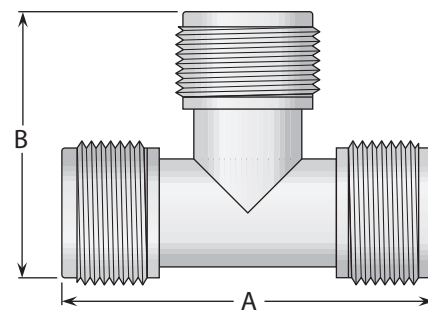

Figure 4
 (Tee jack-jack-jack; connects three jacks)

Figure 5
 (Tee plug-jack-plug; connects two jacks and one plug)

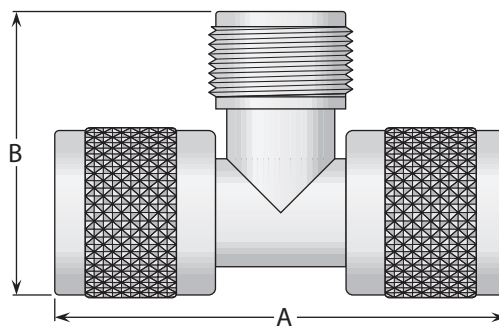

Figure	Dimensions		Plating		Delta P/N
	A	B	Body	Contact	
1	1.50	1.38	Nickel	Silver (C)	UG-212C/U
2	1.63	1.63	Nickel	Silver (C)	1637000N000-000
3	1.94	1.88	Nickel	Silver (C)	1630000N000-000
4	1.94	1.28	Nickel	Silver (C)	1638000N000-000
5	2.33	1.50	Nickel	Silver (C)	UG-1109/U

• (C) in contact plating column indicates captive contact. • See page 6 for alternate body plating information.

General Description

Delta LC and LT series connectors (which are similar in size, but not intermateable), are large, high-voltage, 50 Ω impedance connectors with 1 1/4–18 threaded mating. They are best suited for use with cables with diameters from .73" to 1.2", such as RG-17 and 117/U, and RG-18 and 118/U. Because of the variety of designs and assembly methods within these series, we suggest that you call us to verify the compatibility of specific connector pairs prior to ordering. As with all other Delta connector series, we welcome your specifications for special configurations.

LC/LT Configurations

Straight Cable Plugs.....	52
Panel Jack Receptacles (square flange)	52
In-Series Adapters	53

LC/LT Specifications

Plug Interface**

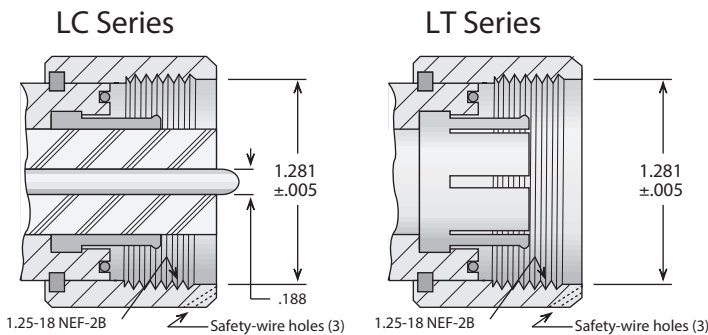

Electrical:

Nominal Impedance: 50 ohms.
 Frequency Range: DC–1 GHz.
 Voltage Rating: 5,000 volts RMS.

Materials/Finishes:

- Insulators: Teflon per ASTM D1710, or rexolite per MIL-P-77.
- Male Contacts: Brass per ASTM B16.
- Female Contacts: Beryllium Copper per ASTM B196.
- Contact Plating : Silver - ASTM B700, or Gold per MIL-DTL-45204.
- Gaskets: Silicone rubber per ZZ-R-765, Class II, Grade 50.
- Other Metal Parts: Brass per ASTM B16
 Plated: Silver - ASTM B700, or Nickel - AMS-QQ-N-290

Jack Interface**

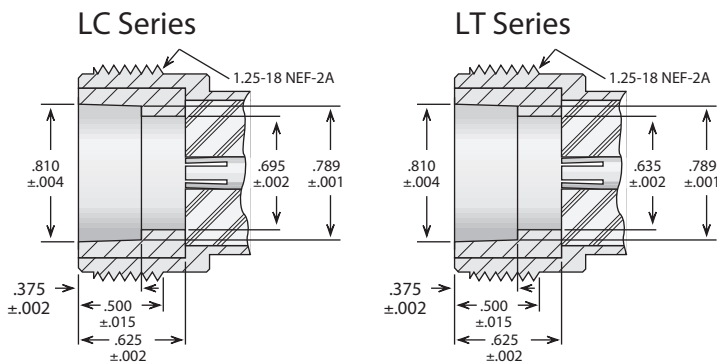

All other specifications are in accordance with the latest issues of MIL-PRF-39012, or MIL-C-3650, or other applicable MIL specifications.

*These specifications are typical and may not apply to all connectors. Detailed specifications for individual connectors are available on request.

**Some proportions altered to illustrate detail.

Panel Receptacles

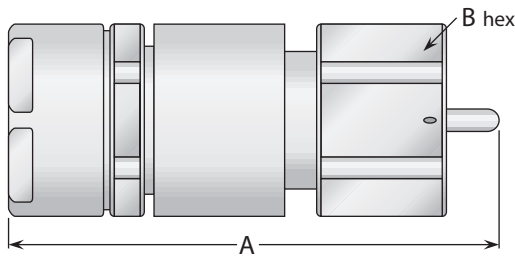

Figure 1
(LC series)

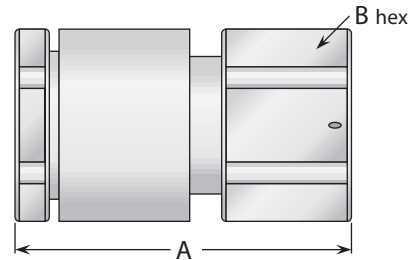

Figure 2
(LT series; uses cable center conductor as contact)

Cable Group	Figure	Dimensions		Plating		Delta P/N	Assembly Procedure/ Trim Code
		A	B	Body	Contact		
17, 18	1	3.50	1.50	Nickel	Silver	UG-154B/U	***
20	2	3.03	1.50	Nickel	—	UG-532A/U	***

Straight Plug - For Flexible Cable

Figure 1
(LC series, Teflon insulator)

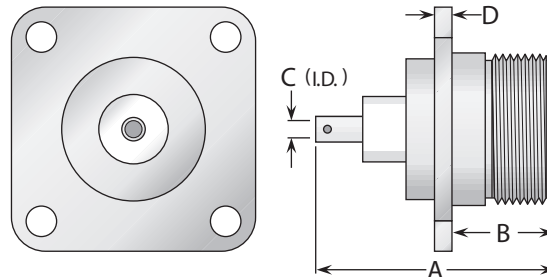

Figure 2
(LC series, pressurized, Rexolite insulator)

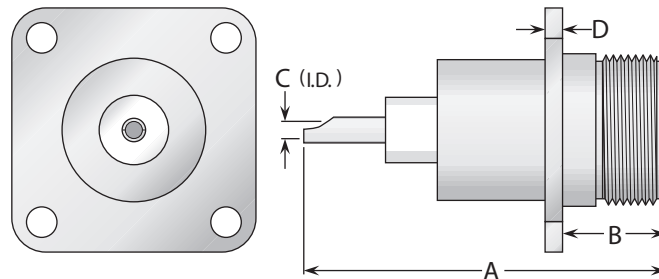

Figure	Dimensions				Mounting Figure	Plating		Delta P/N
	A	B	C	D		Body	Contact	
1	2.25	1.13	.187	.125	45	Nickel	Silver (C)	UG-352/U
2	3.06	.880	.203	.125	45	Nickel	Silver (C)	UG-352B/U

- See page 209 for cable groups.
- ***Contact factory for cable assembly instructions.
- (C) in contact plating column indicates captive contact.
- See page 208 for mounting dimensions.
- See page 6 for alternate body plating information.

Note: Not all LC series plugs and jacks are intermateable.
Contact factory for compatibility information on specific plug/jack combinations.

LC Series Adapters

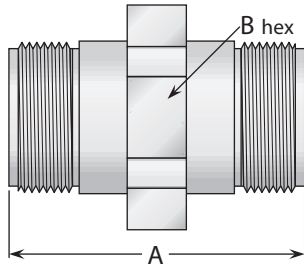

Figure 1
(Straight jack-jack;
connects two plugs)

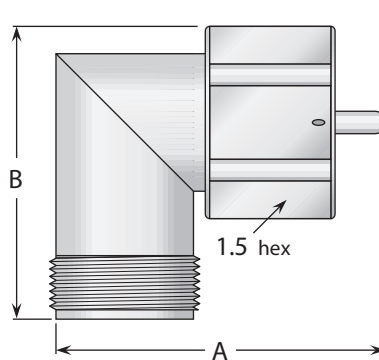

Figure 2
(Right angle plug-jack;
connects one plug and one jack)

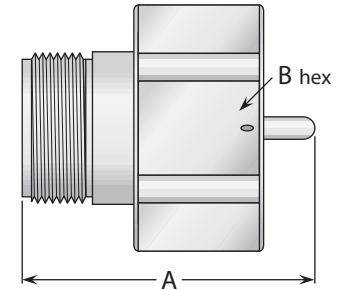

Figure 3
(Straight LC jack-large LC plug;
connects one LC plug
and one large LC jack)

Figure	Dimensions		Plating		Delta P/N
	A	B	Body	Contact	
1	2.50	1.875	Nickel	Silver (C)	UG-157B/U
2	2.72	2.60	Nickel	Silver (C)	UG-216B/U
3	2.22	2.09	Nickel	Silver (C)	UG-220B/U

LT Series Adapters

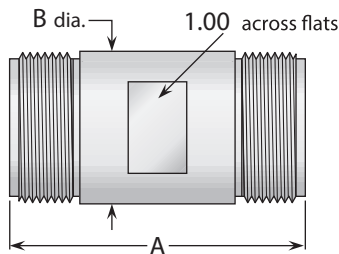

Figure 1
(Straight jack-jack;
connects two plugs)

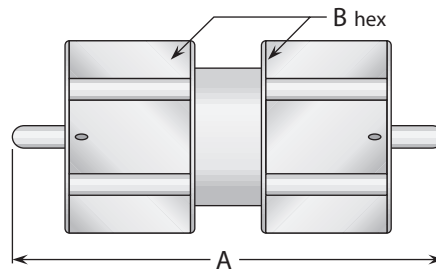

Figure 2
(Straight plug-plug;
connects two jacks)

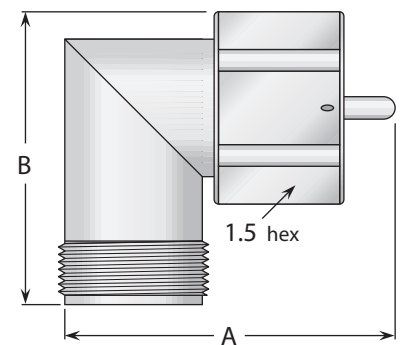

Figure 3
(Right angle plug-jack;
connects one plug and one jack)

Figure	Dimensions		Plating		Delta P/N
	A	B	Body	Contact	
1	2.50	1.25	Nickel	Silver (C)	UG-533B/U
2	3.70	1.50	Nickel	Silver (C)	3527000N001-000
3	2.81	2.56	Nickel	Silver (C)	UG-534B/U

(C) in contact plating column indicates captive contact. • See page 6 for alternate body plating information.

Note: Not all LC series plugs and jacks are intermateable.
Contact factory for compatibility information on specific plug/jack combinations.

General Description

Delta MCX connectors are subminiature, 50Ω impedance connectors with snap-on coupling. They are best suited for use with cables in the range of .070" to .120" diameter, such as RG-178 and RG-316/U.

These connectors provide small size, light weight, and economy with the convenience of snap-on mating and the ability to rotate connector pairs after mating for precise alignment

All Delta MCX connectors are available with gold-plated bodies, or with nickel-plated bodies for economy.

As with our other connector series, Delta's customer-driven design results in MCX series connectors with practical and unique features that make your design and assembly process easier. Some of these include:

- PressMount receptacles (page 58) mount securely in a single round hole, saving space on your components and reducing your housing fabrication costs.
- P. C. board receptacles (page 57) with a choice of through-hole, edge mounting, or surface mounting.
- P. C. board jack receptacles (page 57) that fit flush with the edge of boards, ideal for daughterboard applications.

Our MCX series product line is still growing, so please call if you don't see what you need.

MCX Configurations

Straight Cable Plugs	55	Straight P.C. Board Jack Receptacles	57
Right Angle Cable Plugs	55	Right Angle P.C. Board Jack Receptacles.....	58
Straight Cable Jacks	56	P.C. Board Plug Receptacles	58
Bulkhead Cable Jacks	56	PressMount Jack Receptacles.....	58

MCX Specifications*

Plug Interface**

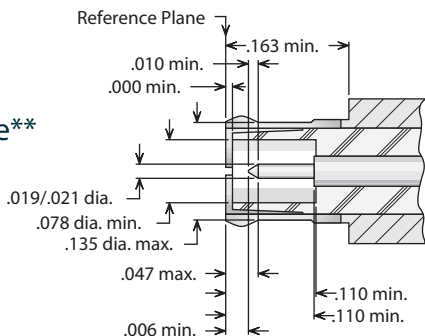

Jack Interface**

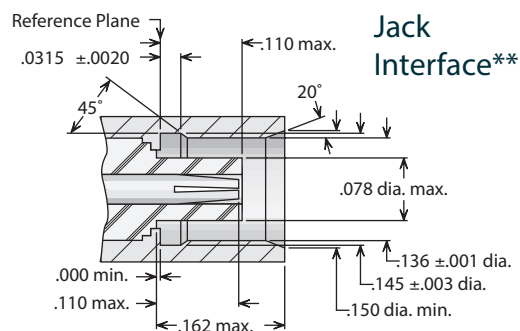

**Some proportions altered to illustrate detail.

Electrical:

- Nominal Impedance: 50 ohms.
- Frequency Range: DC-6 GHz.
- Voltage Rating: 250-335 volts RMS (dependent on cable).
- Dielectric Withstanding Voltage: 750-1000 volts RMS (dependent on cable).
- Insulation Resistance: 1,000 megohms.

Materials/Finishes:

- Insulators: Teflon per ASTM D1710.
- Male Contacts: Brass per ASTM B16, or Beryllium Copper per ASTM B196.
- Female Contacts: Beryllium Copper per ASTM B196.
- Contact Plating: Gold per MIL-DTL-45204.
- Gaskets: Silicone rubber per ZZ-R-765, Class II, Grade 50.
- Other Metal Parts: Brass per ASTM B16 or equivalent, plated Gold - MIL-DTL-45204, or Nickel - AMS-QQ-N-290.

All other specifications are in accordance with the latest issues of CECC 22220, series MCX.

*These specifications are typical and may not apply to all connectors. Detailed specifications for individual connectors are available on request.

Straight Cable Plugs

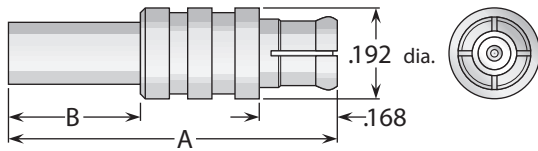

Figure 1
(Crimp type for flexible cable)

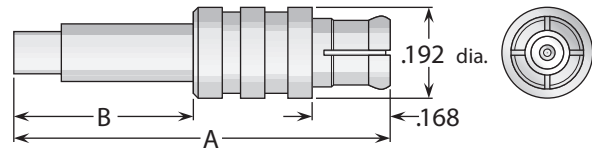

Figure 2
(Crimp type for flexible cable)

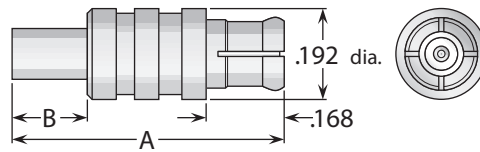

Figure 3
(Direct solder for semi-rigid cable)

Cable Group	Figure	Dimensions		Plating		Delta P/N	Assembly Procedure/ Trim Code
		A	B	Body	Contact		
9	1	.690	.270	Gold*	Gold	9803037G000-500	B/32
10	1	.690	.270	Gold*	Gold	9803100G000-500	B/32
11	2	.790	.370	Gold*	Gold	9803038G000-500	B/33
14	3	.580	.160	Gold*	Gold	9801025G003-500	H/03

Right Angle Cable Plugs

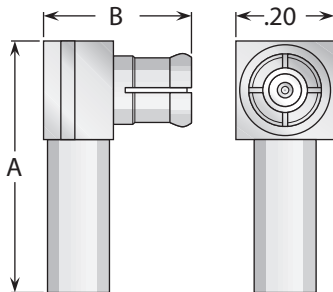

Figure 1
(Crimp type for flexible cable)

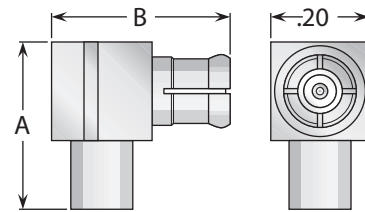

Figure 2
(Direct solder for semi-rigid cable)

Cable Group	Figure	Dimensions		Plating		Delta P/N	Assembly Procedure/ Trim Code
		A	B	Body	Contact		
9	1	.470	.310	Gold*	Gold (C)	9807037G001-500	L/04
10	1	.470	.310	Gold*	Gold (C)	9807100G001-500	L/04
11	1	.470	.310	Gold*	Gold (C)	9807038G001-500	L/04
13	2	.380	.410	Gold*	Gold (C)	9805031G003-500	J/01
14	2	.380	.370	Gold*	Gold (C)	9805025G003-500	J/03

- * Also available with nickel-plated body—change G in Delta part number to N.
- See page 209 for cable groups.
- (C) in contact plating column indicates captive contact.
- Assembly procedures start on page 210.

Straight Cable Jacks

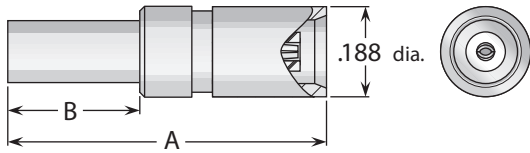

Figure 1
(Crimp type for flexible cable)

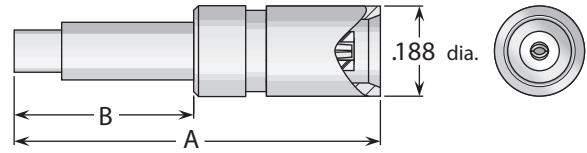

Figure 2
(Crimp type for flexible cable)

Cable Group	Figure	Dimensions		Plating		Delta P/N	Assembly Procedure/ Trim Code
		A	B	Body	Contact		
9	1	.660	.270	Gold*	Gold (C)	9810037G001-500	B/34
10	1	.660	.270	Gold*	Gold (C)	9810100G001-500	B/34
11	2	.780	.370	Gold*	Gold (C)	9810038G001-500	B/35

Straight Bulkhead Jack - For Flexible Cable

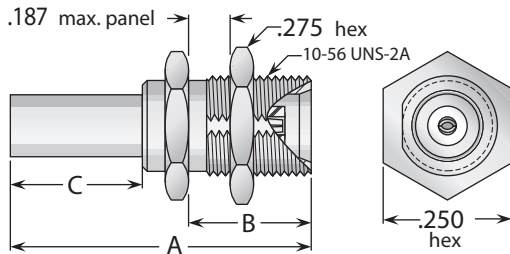

Figure 1
(Crimp type for flexible cable)

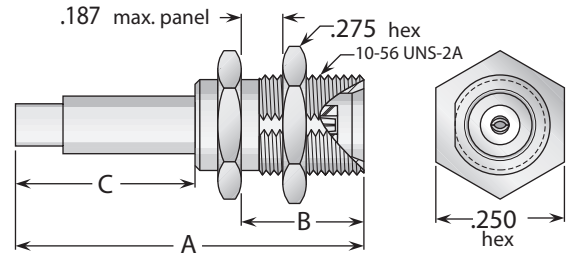

Figure 2
(Crimp type for flexible cable)

Cable Group	Fig.	Dimensions			Mounting Figure	Plating		Delta P/N	Assembly Procedure/ Trim Code
		A	B	C		Body	Contact		
9	1	.690	.307	.270	68	Gold*	Gold (C)	9819037G681-500	B/36
10	1	.690	.307	.270	68	Gold*	Gold (C)	9819100G681-500	***
11	2	.790	.307	.370	68	Gold*	Gold (C)	9819038G681-500	***

* Also available with nickel-plated body—change G in Delta part number to N. • See page 208 for mounting dimensions.
(C) in contact plating column indicates captive contact. • See page 209 for cable groups.
Assembly procedures start on page 201. • ***Contact factory for assembly procedures.

Straight Printed - Circuit Board Jack Receptacles

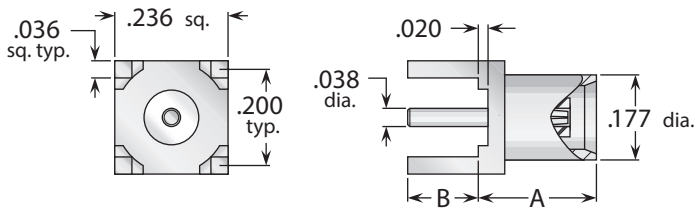

Figure 1
(Through-hole mount)

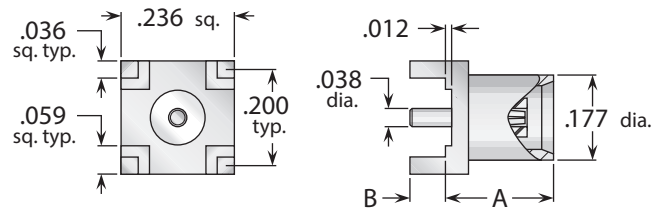

Figure 2
(Through-hole mount)

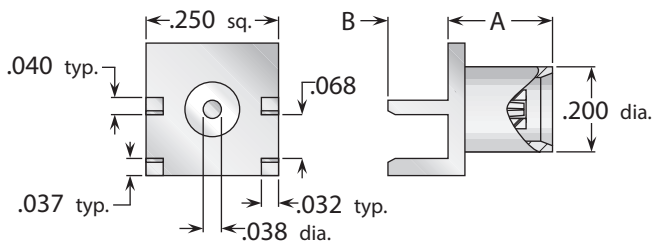

Figure 3
(Edge mount, for .062" thick board)

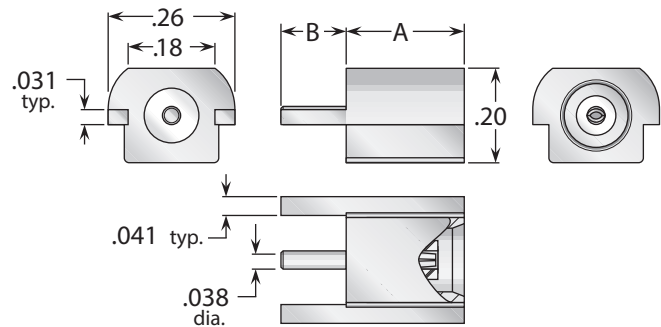

Figure 4
(Flush edge mount)

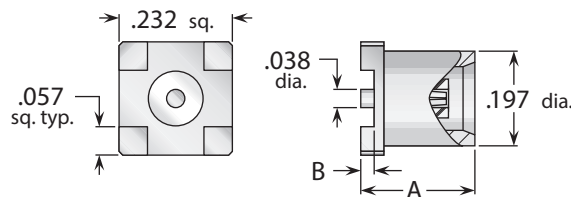

Figure 5
(Surface mount)

Figure	Dimensions		Max. Board	Mounting Figure	Plating		Delta P/N
	A	B			Body	Contact	
1	.240	.155	.100	PCB06	Gold*	Gold (C)	9867000G001-500
2	.240	.059	.040	PCB06	Gold*	Gold (C)	9867000G001-501
3	.250	.125	N/A	***	Gold*	Gold (C)	9867000G91P-500
4	.246	.120	N/A	***	Gold*	Gold (C)	9867000G001-503
5	.236	.016	N/A	***	Gold*	Gold (C)	9867000G001-504

• * Also available with nickel-plated body—change G in Delta part number to N. • See page 208 for mounting dimensions.
• (C) in contact plating column indicates captive contact. • ***Contact factory for mounting information.

Right Angle Printed - Circuit Board Jack Receptacle

Figure 1
(Through-hole mount)

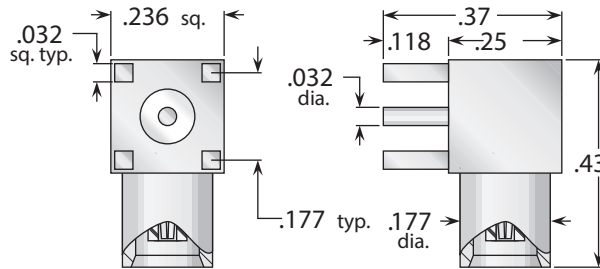

Figure	Max. Board Thickness	Mounting Figure	Plating		Delta P/N
			Body	Contact	
1	.062	PCB07	Gold*	Gold (C)	9869000G001-500

Printed - Circuit Board Plug Receptacles

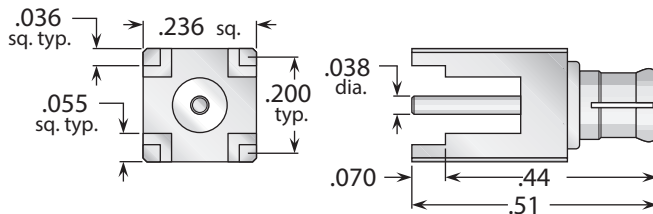

Figure 1
(Straight—through-hole mounting)

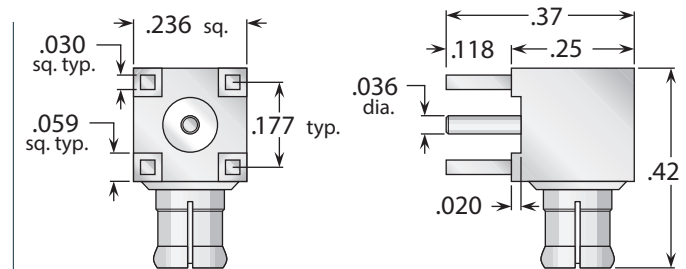
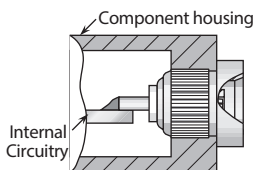

Figure 2
(Right angle—through-hole mounting)

Figure	Max. Board Thickness	Mounting Figure	Plating		Delta P/N
			Body	Contact	
1	.050	PCB06	Gold*	Gold (C)	9868000G001-500
2	.062	PCB07	Gold*	Gold (C)	9870000G001-500

Press Mount Receptacles



Delta PressMount Receptacles

These connectors eliminate the need for complicated mounting hole patterns and mounting hardware.

They are simply pressed into a single through hole, and the precisely-engineered knurled mounting section provides retention strength far greater than normal mating and unmating forces. An integral shoulder provides a positive stop when mounting.

Figure 1 (Post contact)

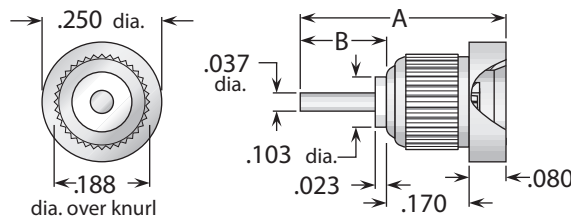

Figure	Dimensions		Min. Panel	Mounting Hole	Plating		Delta P/N
	A	B			Body	Contact	
1	.400	.150	.100	.184 ±.001 dia.	Gold*	Gold (C)	9820000G911-001
1	.730	.480	.100	.184 ±.001 dia.	Gold*	Gold (C)	9820000G911-008

- * Also available with nickel-plated body—change G in Delta part number to N.
- See page 208 for mounting dimensions.
- (C) in contact plating column indicates captive contact.

General Description

Delta MHV connectors are compact, 50 Ω impedance, high-voltage connectors with two-stud bayonet coupling. MHV connectors are similar in size to, but are not interchangeable with, BNC connectors. They are best suited for use with cables in the range of .195" to .220" diameter, but are available for other cables from .090" to over .75" diameter. For safety, Delta MHV connectors feature deeply recessed contacts, as well as polarized plugs and jacks to ensure that only the compatible plugs and jacks can be mated in applications incorporating multiple connector pairs. As with all other Delta connector series, we welcome your specifications for special configurations.

MHV Configurations

Standard mating

Straight Cable Plugs60
Right Angle Cable Plugs60
Straight Cable Jacks61
Bulkhead Cable Jacks61
Panel Cable Jacks61
Panel Jack Receptacles (square flange)62
Bulkhead Jack Receptacles62

Polarized mating

Straight Cable Plugs60
Bulkhead Cable Jacks61
Panel Cable Jacks61
Panel Jack Receptacles (square flange)62
Bulkhead Jack Receptacles62

MHV Specifications

Plug Interface**

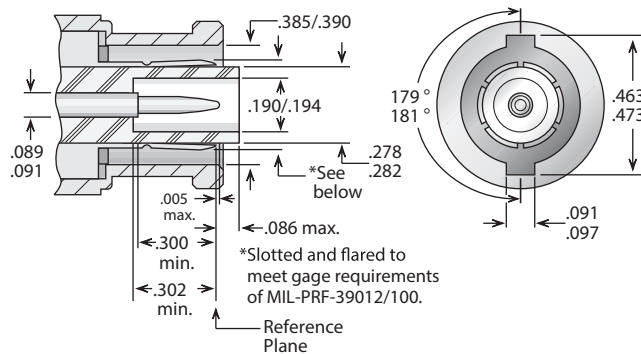

Electrical:

Nominal Impedance: Nonconstant.
 Frequency Range: DC-50 MHz.
 Voltage Rating: 3,500 volts RMS;
 5,000 volts DC.
 Dielectric Withstanding Voltage: 5,000 VRMS.
 Insulation Resistance: 5,000 megohms.

Materials/Finishes:

Insulators: Teflon per ASTM D1710.
 Male Contacts: Brass per ASTM B16.
 Female Contacts: Beryllium Copper per ASTM B196.
 Contact Plating: Silver - ASTM B700, or
 Gold - MIL-DTL-45204.

Gaskets: Silicone rubber per ZZ-R-765,
 Class II, Grade 50.

Other Metal Parts: Brass per ASTM B16, plated:
 Silver - ASTM B700, or
 Nickel - AMS-QQ-N-290

Jack Interface**

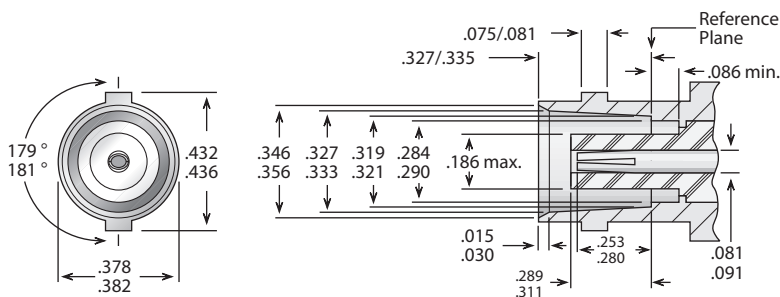

All other specifications are in accordance with the latest issues of MIL-PRF-39012, or MIL-C-3643, or other applicable MIL specifications, and interfaces are in accordance with MIL-STD-348.

*These specifications are typical and may not apply to all connectors. Detailed specifications for individual connectors are available on request.

**Some proportions altered to illustrate detail.

Straight & Right Angle Plugs For Flexible Cable - Standard Mating

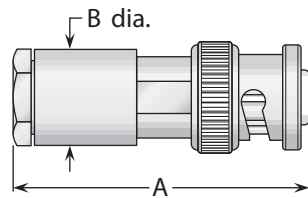

Figure 1
(Clamp type)

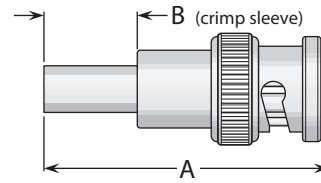

Figure 2
(Crimp type)

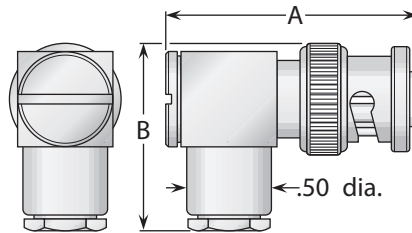

Figure 3
(Clamp type)

Cable Group	Figure	Dimensions		Plating		Delta P/N	Assembly Procedure/ Trim Code
		A	B	Body	Contact		
5, 6	1	1.56	.500	Nickel	Silver	1701015N000-000	A/30
7	1	1.56	.500	Nickel	Silver	UG-932A/U	A/30
8A	1	1.56	.500	Nickel	Silver	1701029N000-000	A/30
5	2	1.44	.500	Nickel	Silver	1703017N000-000	B/25
7	2	1.44	.500	Nickel	Silver	1703020N000-000	B/25
5, 6	3	1.27	1.03	Nickel	Silver (C)	1705015N000-000	A/32
7	3	1.27	1.03	Nickel	Silver (C)	1705021N000-000	A/32

Straight Plug For Flexible Cable - Polarized Mating

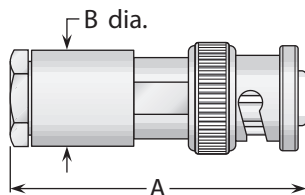

Figure 1
(Clamp type)

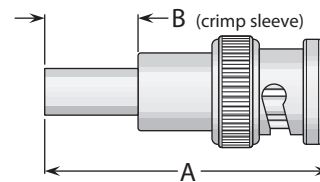

Figure 2
(Crimp type)

Cable Group	Figure	Dimensions		Plating		Delta P/N	Assembly Procedure/ Trim Code
		A	B	Body	Contact		
5, 6	1	1.56	.500	Nickel	Silver	1701015N002-000	A/30
8A	1	1.56	.500	Nickel	Silver	1701029N002-000	A/30
5	2	1.44	.500	Nickel	Silver	1703017N002-000	B/25
7	2	1.44	.500	Nickel	Silver	1703020N002-000	B/25

- See page 209 for cable groups.
- Assembly procedures start on page 210.
- (C) in contact plating column indicates captive contact.
- See page 6 for alternate body plating information.

Cable Jacks For Flexible Cable - Standard Mating

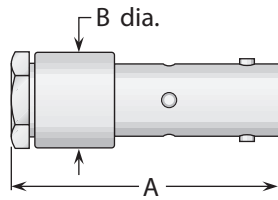

Figure 1
(Straight jack, clamp type)

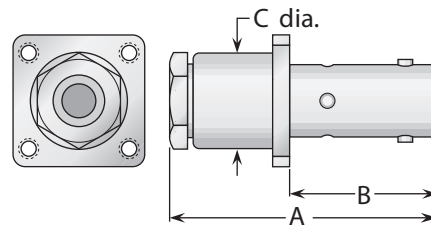

Figure 2
(Panel jack, clamp type)

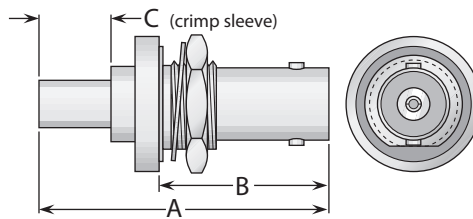

Figure 3
(Bulkhead jack, crimp type)

Cable Group	Fig.	Dimensions			Mounting Figure	Max. Panel	Plating		Delta P/N	Assembly Procedure/Trim Code
		A	B	C			Body	Contact		
5, 6	1	1.50	.500	—	—	—	Nickel	Silver	1708015N000-000	A/31
7	1	1.50	.500	—	—	—	Nickel	Silver	UG-1016A/U	A/31
5, 6	2	1.44	.780	.440	07	—	Nickel	Silver	1711014N070-000	C/07
7	2	1.50	.780	.500	07	—	Nickel	Silver	UG-961A/U	A/31
5	3	1.70	.890	.500	59	.200	Nickel	Silver	1719017N590-000	B/24
7	3	1.70	.890	.500	59	.200	Nickel	Silver	1719021N590-000	B/24

Cable Jacks For Flexible Cable - Polarized Mating

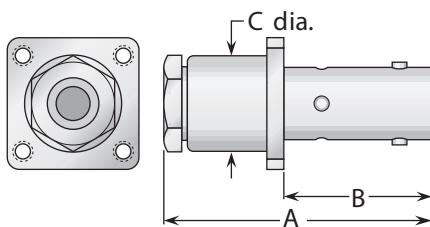

Figure 1
(Panel jack, clamp type)

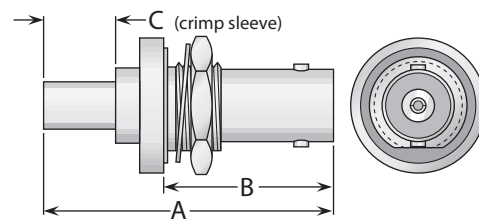

Figure 2
(Bulkhead jack, crimp type)

Cable Group	Fig.	Dimensions			Mounting Figure	Max. Panel	Plating		Delta P/N	Assembly Procedure/Trim Code
		A	B	C			Body	Contact		
5, 6	1	1.50	.780	.500	07	—	Nickel	Silver	1711014N072-000	A/31
5	2	1.88	1.08	.500	59	.200	Nickel	Silver	1719017N592-000	B/24
7	2	1.88	1.08	.500	59	.200	Nickel	Silver	1719021N592-000	B/24

- See page 209 for cable groups.
- Assembly procedures start on page 210.
- See page 208 for mounting dimensions.
- (C) in contact plating column indicates captive contact.
- See page 6 for alternate body plating information.

Bulkhead & Panel Receptacles - Standard Mating

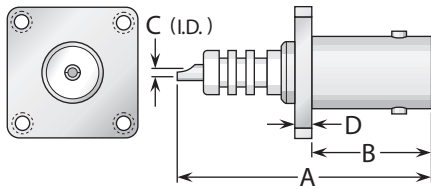

Figure 1
(Panel jack receptacle)

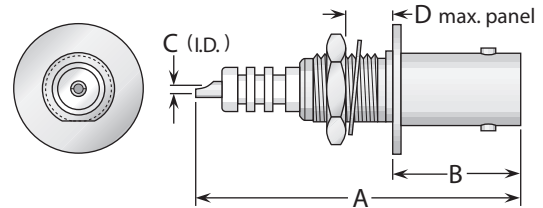

Figure 2
(Bulkhead jack receptacle, front mount, no mounting gasket)

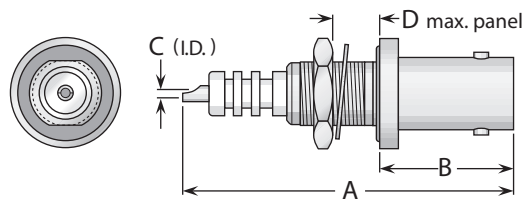

Figure 3
(Bulkhead jack receptacle, front mount, with mounting gasket)

Figure	Dimensions				Mounting Figure	Plating		Delta P/N
	A	B	C	D		Body	Contact	
1	1.34	.630	.043	.090	07	Nickel	Gold (C)	UG-931/U
2	1.42	.470	.043	.110	65	Nickel	Gold (C)	1720000N651-003
3	1.69	.590	.043	.230	75	Nickel	Gold (C)	1720000N751-001

Bulkhead & Panel Receptacles - Polarized Mating

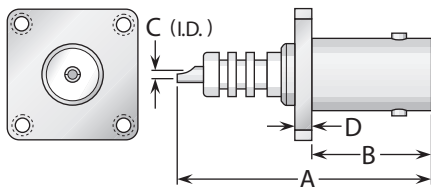

Figure 1
(Panel jack receptacle)

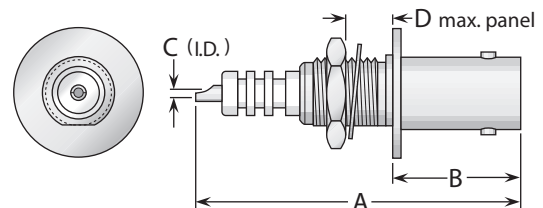

Figure 2
(Bulkhead jack receptacle, front mount, no mounting gasket)

Figure	Dimensions				Mounting Figure	Plating		Delta P/N
	A	B	C	D		Body	Contact	
1	1.34	.630	.043	.090	07	Nickel	Gold (C)	1713000N072-000
2	1.54	.510	.043	.180	65	Nickel	Gold (C)	1720000N652-000

- (C) in contact plating column indicates captive contact.
- See page 6 for alternate body plating information.
- See page 208 for mounting dimensions.

General Description

Delta MMCX connectors are microminiature, 50 Ω impedance connectors with snap-on coupling. They are best suited for use with cables in the range of .070" to .120" diameter, such as RG-178 and RG-316/U.

These connectors provide small size, light weight, and economy with the convenience of snap-on mating and the ability to rotate connector pairs after mating for precise alignment. Their non-slotted outer contact provides for low RF leakage. All Delta MMCX connectors are available with gold-plated bodies, or with nickel-plated bodies for economy.

As with our other connector series, Delta's customer-driven design results in MMCX series connectors with practical and unique features that make your design and assembly process easier. Some of these include:

- MMCX P. C. board receptacles (page 65) with a choice of through-hole, edge mounting, or surface mounting.
- P. C. board jack receptacles (page 65) that fit flush with the edge of boards, ideal for daughterboard applications.

Our MMCX series product line is still growing, so please call if you don't see what you need.

MMCX Configurations

Straight Cable Plugs	64	Straight P.C. Board Jack Receptacles	65
Right Angle Cable Plugs	64	Right Angle P.C. Board Jack Receptacles.....	65
Straight Cable Jacks	64	Straight P.C. Board Plug Receptacles.....	65

MMCX Specifications*

Plug Interface**

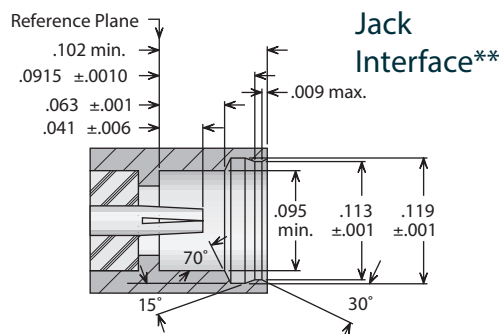
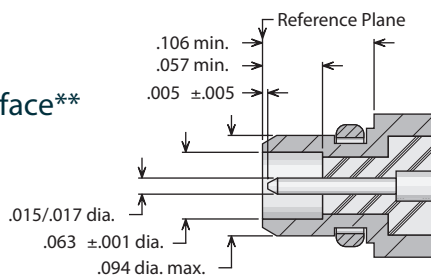

**Some proportions altered to illustrate detail.

Electrical:

Nominal Impedance: 50 ohms.

Frequency Range: DC-6 GHz.

Voltage Rating: 170 volts RMS.

Dielectric Withstanding Voltage: 500 volts RMS.

Insulation Resistance: 1,000 megohms.

Materials/Finishes:

Insulators: Teflon per ASTM D1710.

Male Contacts: Brass per ASTM B16, or Beryllium Copper per ASTM B196.

Female Contacts: Beryllium Copper - ASTM B196.

Contact Plating: Gold - MIL-DTL-45204.

Gaskets: Silicone rubber per ZZ-R-765, Class II, Grade 50.

Other Metal Parts: Brass - ASTM B16 or equivalent; plated Gold - MIL-DTL-45204, or Nickel - AMS-QQ-N-290.

All other specifications are in accordance with the latest issues of CECC 22000.

*These specifications are typical and may not apply to all connectors. Detailed specifications for individual connectors are available on request.

Straight & Right Angle Cable Plugs

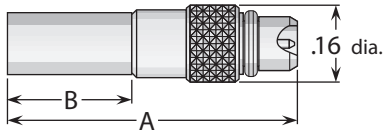

Figure 1
(Straight crimp type for flexible cable)

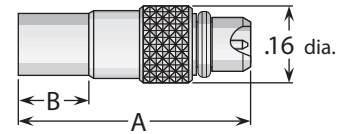

Figure 2
(Straight direct solder for semi-rigid cable)

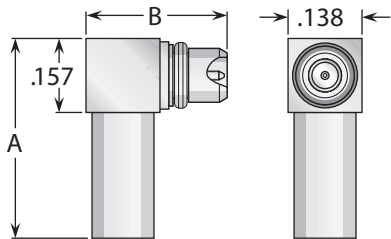

Figure 3
(Right angle crimp type for flexible cable)

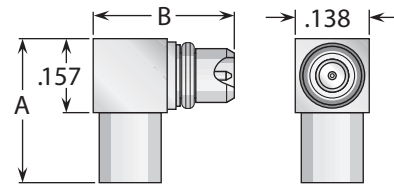

Figure 4
(Right angle direct solder for semi-rigid cable)

Cable Group	Figure	Dimensions		Plating		Delta P/N	Assembly Procedure/ Trim Code
		A	B	Body	Contact		
9	1	.610	.270	Gold*	Gold	9503037G000-500	B/37
9	3	.430	.270	Gold*	Gold (C)	9507037G001-500	L/04
11	1	.610	.270	Gold*	Gold	9503038G000-500	B/37
11	3	.430	.270	Gold*	Gold (C)	9507038G001-500	L/04
14	2	.490	.160	Gold*	Gold	9501025G003-500	H/01
14	4	.300	.270	Gold*	Gold (C)	9505025G003-500	J/04

Straight Cable Jacks

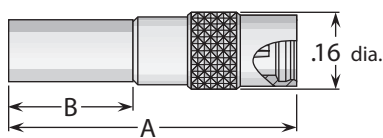

Figure 1
(Crimp type for flexible cable)

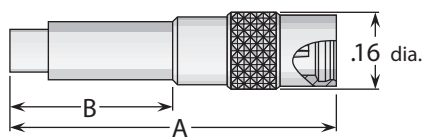

Figure 2
(Crimp type for flexible cable)

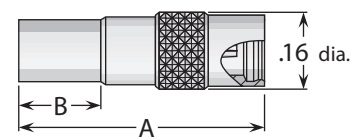

Figure 3
(Direct solder for semi-rigid cable)

Cable Group	Figure	Dimensions		Plating		Delta P/N	Assembly Procedure/ Trim Code
		A	B	Body	Contact		
9	1	.630	.270	Gold*	Gold	9510037G000-500	B/37
11	2	.700	.370	Gold*	Gold	9510038G000-500	B/39
14	3	.510	.160	Gold*	Gold	9510025G003-500	H/01

- * Also available with nickel-plated body—change G in Delta part number to N.
- See page 209 for cable groups.
- (C) in contact plating column indicates captive contact.
- Assembly procedures start on page 210.

Printed - Circuit Board Jack Receptacles

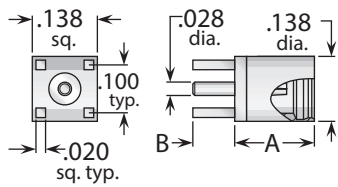

Figure 1
(Straight through-hole mount)

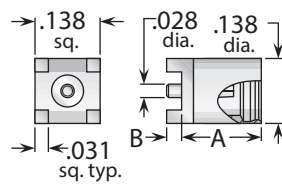

Figure 2
(Straight surface mount)

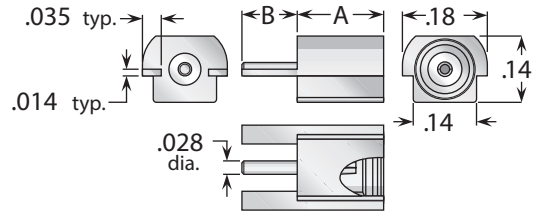

Figure 3
(Straight flush edge mount)

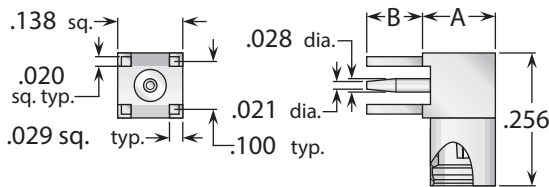

Figure 4
(Right angle through-hole mount)

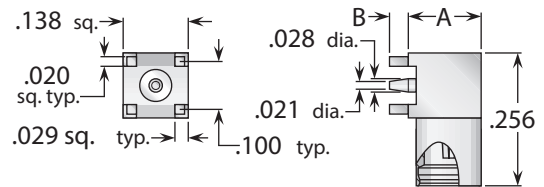

Figure 5
(Right angle surface mount)

Figure	Dimensions		Max. Board	Mounting Figure	Plating		Delta P/N
	A	B			Body	Contact	
1	.171	.120	.100	PCB08	Gold*	Gold (C)	9567000G001-500
1	.166	.031	.020	PCB08	Gold*	Gold (C)	9567000G001-501
2	.166	.031	N/A	**	Gold*	Gold (C)	9567000G001-503
3	.171	.120	N/A	**	Gold*	Gold (C)	9567000G001-502
4	.150	.118	.100	PCB08	Gold*	Gold (C)	9569000G001-500
5	.150	.031	N/A	**	Gold*	Gold (C)	9569000G001-501

Printed - Circuit Board Plug Receptacles

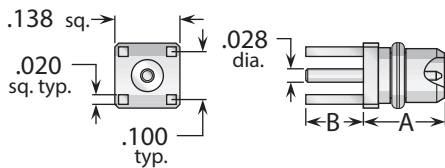

Figure 1
(Straight through-hole mount)

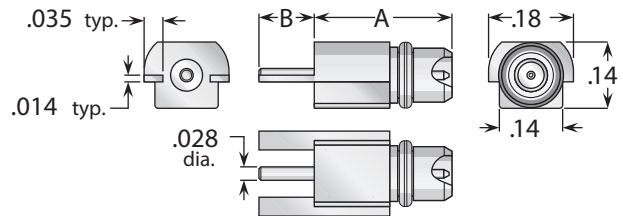

Figure 2
(Straight flush edge mount)

Figure	Dimensions		Max. Board	Mounting Figure	Plating		Delta P/N
	A	B			Body	Contact	
1	.171	.120	.100	PCB08	Gold*	Gold (C)	9568000G001-500
2	.282	.120	N/A	**	Gold*	Gold (C)	9568000G001-501
2	.173	.120	N/A	**	Gold*	Gold (C)	9568000G001-502

* Also available with nickel-plated body—change G in Delta part number to N. • See page 208 for mounting dimensions.
 • **Contact factory for mounting dimensions. • (C) in contact plating column indicates captive contact.

General Description

Delta MQD (Miniature QDS) connectors feature the same positive-locking, push-on mating as QDS series connectors, but in a miniature size equivalent to BNC and TNC connectors. Along with the convenience of quick-connect and quick-disconnect mating, they exhibit good VSWR to 9 GHz.

Our MiniQDS series product line is still growing, so please call if you don't see what you need.

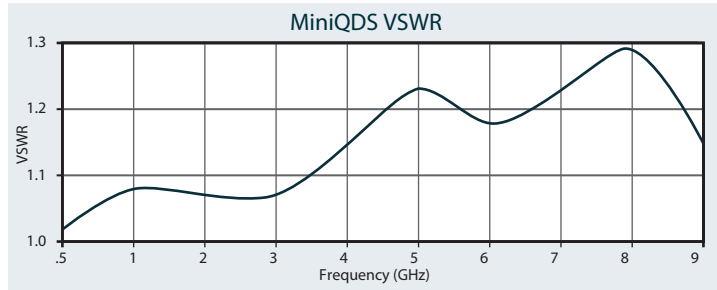

Contact factory for other specifications and interface dimensions.

Straight Plug - Crimp Type For Flexible Cable

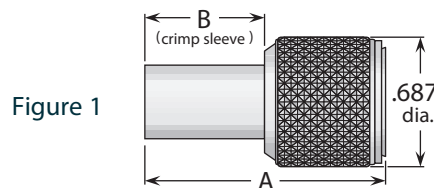

Cable Group	Figure	Dimensions		Plating		Delta P/N	Assembly Procedure/Trim Code
		A	B	Body	Contact		
6	1	1.05	.500	Albaloy*	Gold	4203015Q000-000	B/23

* Crimp sleeve is nickel plated.

Panel Jack Receptacle - Square Flange

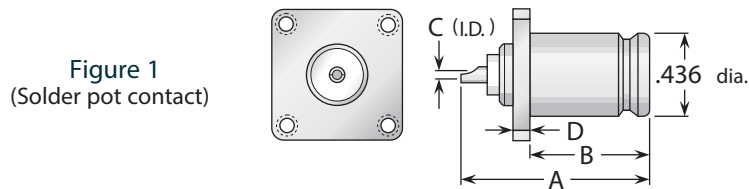

Also available with other contact/insulator configurations and flange sizes

Figure	Dimensions				Mounting Figure	Plating		Delta P/N
	A	B	C	D		Body	Contact	
1	1.06	.630	.062	.090	07	Albaloy	Gold (C)	4213000Q071-001

Adapter Between Series

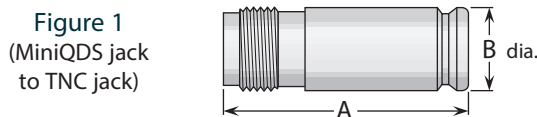

Figure	Dimensions		Plating		Delta P/N
	A	B	Body	Contact	
1	1.28	.436	Albaloy	Gold (C)	2234000Q001-136

- See page 209 for cable groups.
- Assembly procedures start on page 210.
- See page 208 for mounting dimensions.
- (C) in contact plating column indicates captive contact.
- See page 6 for alternate body plating information.

General Description

Delta type N connectors are medium size, 50 Ω impedance connectors with 5/8"-24 threaded coupling. They are best suited for use with cables in the range of .350" to .450" diameter, but are available for other cables with diameters from .100" to over 1". Many of our N connectors are available as MIL-PRF-39012 QPL versions, and adapters as MIL-PRF-55339 versions. These types are listed starting on page 190. Our extensive line of type N receptacles includes configurations for virtually any packaging requirement, and we can supply any adapter or accessory you need to complete your system design. Adapters between type N and other series are shown starting on page 176.

As with our other connector series, Delta's customer-driven design results in N series connectors with practical and unique features that make your design and assembly process easier. Some of these include:

- Heli-Grip cable connectors for fast, reliable assembly to flexible cable without special tooling.
- One-Step cable connectors for quick, accurate assembly to semi-rigid cable.
- PressMount receptacles (page 85) mount securely in a single round hole, saving space on your components and reducing your housing fabrication costs.
- Panel receptacles with flange sizes to match the same hole pattern as standard SMA or BNC/TNC connectors, letting you drill one hole pattern and mount BNC, N, SMA, TNC, or 7/16 series connectors as needed.
- 70 Ω impedance N connectors (see page 89) for matched-impedance applications.

Our N series product line is still growing, so please call if you don't see what you need.

N Configurations

Straight Cable Plugs	68	Dummy Receptacles	82
Right Angle Cable Plugs	71	Right Angle Panel Jack Receptacles	82
Tee Cable Plugs	72	Panel Plug Receptacles.....	83
Straight Cable Jacks	72	Bulkhead Jack Receptacles	84
Bulkhead Cable Jacks	74	Stripline Receptacles	84
Tee Bulkhead Cable Jacks	75	PressMount Receptacles.....	85
Panel Cable Jacks	76	Resistive Terminations	86
Panel Jack Receptacles (square flange)	79	Dust Caps	86
Panel Jack Receptacles (round flange)	79	In-Series Adapters	87

N Specifications*

Electrical:

Nominal Impedance: 50 ohms.

Frequency Range: DC–11 GHz.

Voltage Rating: 1,000 volts RMS.

Dielectric Withstanding Voltage: 2,500 volts RMS.

Insulation Resistance: 5,000 megohms.

Materials/Finishes:

Insulators: Teflon per ASTM D1710.

Male Contacts: Brass per ASTM B16.

Female Contacts: Beryllium Copper per ASTM B196.

Contact Plating: Silver per ASTM B700, or

Gold per MIL-DTL-45204.

Gaskets: Silicone rubber per ZZ-R-765, Class II, Grade 50.

Other Metal Parts: Brass per ASTM B16, plated:

Silver per ASTM B700, or

Nickel per AMS-QQ-N-290.

All other specifications are in accordance with the latest issues of MIL-PRF-39012, or MIL-A-55339, or other applicable MIL specifications, and interfaces are in accordance with MIL-STD-348.

Plug Interface**

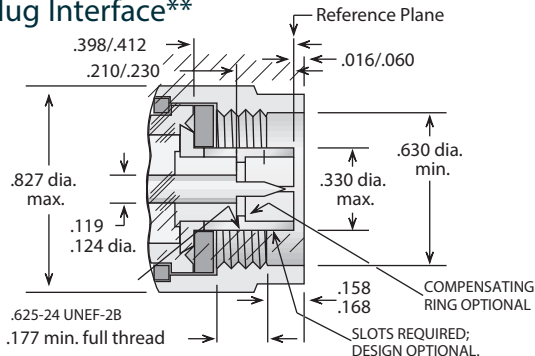

Jack Interface**

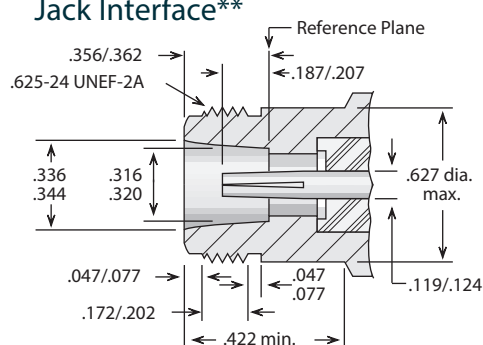

*These specifications are typical and may not apply to all connectors. Detailed specifications for individual connectors are available on request.

**Some proportions altered to illustrate detail.

Straight Plug - Military Clamp For Flexible Cable

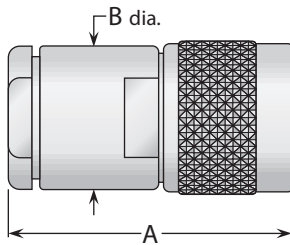

Figure 1

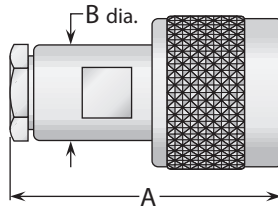

Figure 2

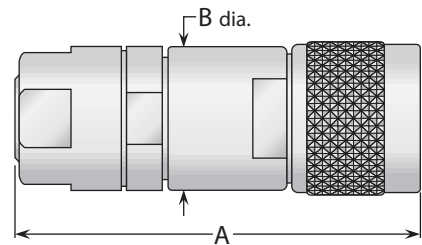
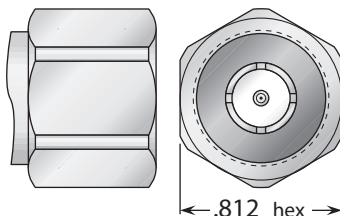

Figure 3
(Includes armor clamp)

Cable Group	Figure	Dimensions		Plating		Delta P/N	Assembly Procedure/ Trim Code
		A	B	Body	Contact		
1	1	1.50	.750	Nickel	Silver	UG-18E/U	A/01
1	1	1.50	.750	Nickel	Silver (C)	1101001N001-000	A/01
2, 3	1	1.80	.680	Nickel	Silver	UG-21B/U	C/01
2, 3	1	1.50	.750	Nickel	Gold	UG-21D/U	A/01
2, 3	1	1.50	.750	Nickel	Gold	UG-21E/U	A/01
2, 3	1	1.50	.750	Nickel	Gold	UG-21G/U	A/01
2, 3	1	1.50	.750	Nickel	Silver (C)	UG-1185/U	A/01
2, 3	1	1.50	.750	Nickel	Gold (C)	UG-1185A/U	A/01
2, 3	1	1.50	.750	Silver	Gold (C)	M39012/01-0005 *	A/01
5, 6	2	1.41	.500	Nickel	Silver	UG-536B/U	A/02
5, 6	2	1.41	.500	Nickel	Gold	UG-536C/U	A/02
5, 6	2	1.41	.500	Nickel	Gold (C)	1101015N001-000	A/02
7	2	1.38	.500	Nickel	Silver	UG-603A/U	A/02
7	2	1.38	.500	Nickel	Silver (C)	1101021N001-000	A/02
8	2	1.41	.500	Nickel	Silver (C)	1101043N001-000	A/02
9	2	1.38	.500	Nickel	Silver	1101036N000-000	A/02
9	2	1.38	.500	Nickel	Silver (C)	1101036N001-000	A/02
15	3	2.42	.750	Nickel	Silver	UG-941B/U	D/01
15	3	2.42	.750	Silver	Gold (C)	M39012/01-0125 *	D/03
16	1	1.80	.880	Nickel	Silver	UG-204A/U	C/02
16	1	1.80	.880	Silver	Gold (C)	M39012/01-0015 *	A/01
20	3	3.09	1.31	Nickel	Silver	UG-557A/U	D/02
25	2	1.38	.500	Nickel	Silver	1101132N000-000	A/03

* Lockwire holes in coupling nut.

Optional Type N Coupling Nut Examples



13/16" hex coupling nut

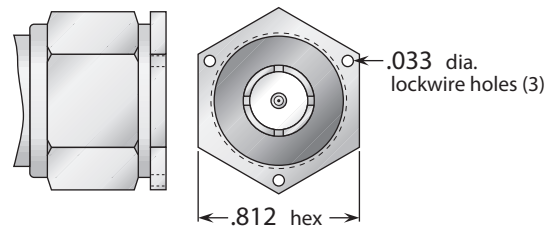

13/16" hex coupling nut with lockwire holes

These designs allow the connectors to be tightened with a wrench for precise torquing of mated parts, and can be supplied on any Delta type N plug. Please call for details of these options or any other special requirements you may have.

- See page 209 for cable groups.
- Assembly procedures start on page 210.
- (C) in contact plating column indicates captive contact.
- See page 6 for alternate body plating information.

Straight Plug - Crimp Type For Flexible Cable

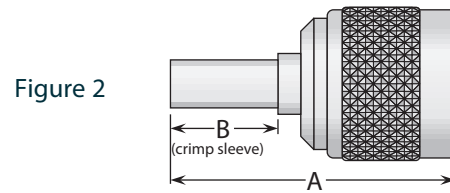
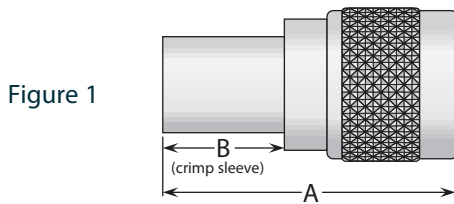

Cable Group	Figure	Dimensions		Plating		Delta P/N	Assembly Procedure/ Trim Code
		A	B	Body	Contact		
2	1	1.51	.630	Nickel	Silver	1103002N000-000	B/01
2	1	1.55	.630	Nickel	Gold (C)	1103002N001-009	B/03
2	1	1.55	.600	Silver	Gold (C)	M39012/01B0007 *	B/03
2	1	1.55	.600	Silver	Gold (C)	M39012/01-0502 *	B/03
2B	1	1.55	.630	Nickel	Silver	1103070N000-000	B/01
3A, 4	1	1.55	.630	Nickel	Gold (C)	1103004N001-001	B/03
3A, 4	1	1.51	.630	Nickel	Silver	1103005N000-000	B/01
3A, 3C, 4	1	1.55	.600	Silver	Gold (C)	M39012/01B0008 *	B/03
3A, 3C, 4	1	1.55	.600	Silver	Gold (C)	M39012/01-0501 *	B/03
4	1	1.50	.630	Nickel	Silver	1103079N000-000	B/01
5	2	1.43	.500	Nickel	Silver	1103017N000-000	B/04
5	1	1.48	.500	Nickel	Gold (C)	1103017N001-000	B/05
6	2	1.43	.500	Nickel	Silver	1103013N000-000	B/04
6	1	1.45	.500	Nickel	Gold (C)	1103018N001-000	B/03
6	1	1.45	.500	Silver	Gold (C)	M39012/01-0503 *	B/03
7	2	1.43	.500	Nickel	Silver	1103020N000-000	B/06
7	1	1.38	.500	Nickel	Gold (C)	1103020N001-000	B/03

* Lockwire holes in coupling nut.

Straight Plug - Heli-Grip® For Flexible Cable

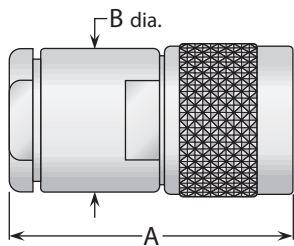

Figure 1

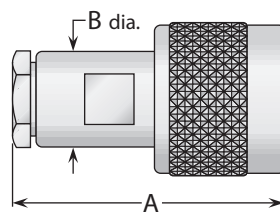
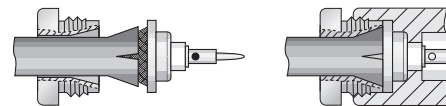

Figure 2

Heli-Grip® Cable Attachment



These connectors have captivated contacts and allow rapid, easy assembly—simply trim the cable, slide into the cone/insulator/contact assembly (left), solder the center conductor to the contact, and screw body assembly (right) onto cable assembly.

Cable Group	Figure	Dimensions		Plating		Delta P/N	Assembly Procedure/ Trim Code
		A	B	Body	Contact		
2	1	1.50	.750	Nickel	Gold (C)	1101004N005-000	E/01
3	1	1.50	.750	Nickel	Gold (C)	1101004N005-006	E/01
5, 6 ^s	2	1.41	.500	Nickel	Gold (C)	1101015N005-000	E/02
RG-223	2	1.41	.500	Nickel	Gold (C)	1101015N005-001	E/02
7	2	1.38	.500	Nickel	Gold (C)	1101021N005-000	E/02
24	1	1.50	.750	Nickel	Gold (C)	1101052N005-000	E/01
26	1	1.50	.750	Nickel	Gold (C)	1101108N005-000	E/01

• See page 209 for cable groups. • Assembly procedures start on page 210.
• (C) in contact plating column indicates captive contact. • See page 6 for alternate body plating information.

Straight Plug - For Semi-Rigid Cable

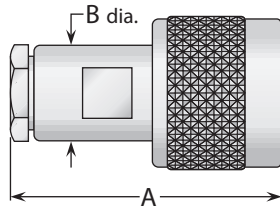

Figure 1
(Solder-clamp; gold-plated ferrule, nickel-plated body)

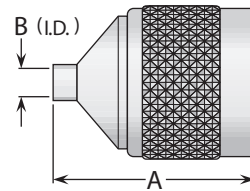
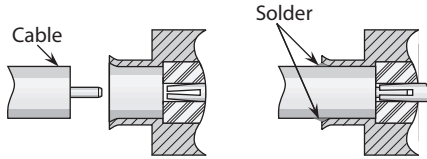

Figure 2
(Direct solder; gold-plated body, nickel ⁽¹⁾ or passivated ⁽²⁾ coupling nut)

Delta One-Step Cable Attachment Straight Plugs - For Semi-Rigid Cable



Delta "One-Step" connectors feature captivated contacts and insulators to allow rapid, easy assembly to semi-rigid cable—simply trim the cable jacket and dielectric flush, chamfer the center conductor, insert into the connector, and solder the jacket to the connector body.

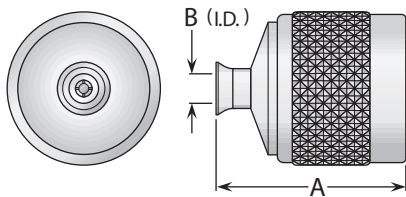

Figure 3
(One-Step cable attachment, standard coupling nut)

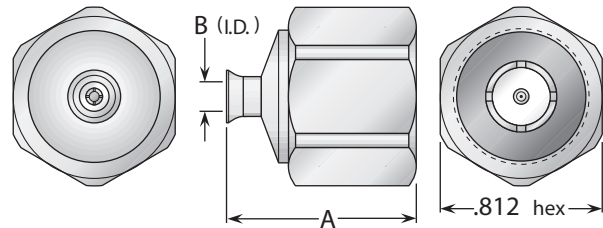

Figure 4
(One-Step cable attachment, hex coupling nut)

Cable Group	Figure	Dimension		Plating		Delta P/N	Assembly Procedure/ Trim Code
		A	B	Body	Contact		
12	1	1.50	.500	Nickel	Silver	1101050N000-000	F/03
12	2	.960	.254	Mixed ⁽¹⁾	Silver	1101050N003-000	***
12	4	1.44	.254	Silver	Gold (C)	1101050A003-007	I/01
13	1	1.41	.500	Nickel	Silver	1101031N003-000	F/01
13	2	.960	.143	Mixed ⁽¹⁾	Gold	1101031N003-001	***
13	2	.960	.143	Mixed ⁽²⁾	Gold	1101031K00M-000	***
13	3	.960	.143	Silver	Gold (C)	1101031A003-008	I/01
13	4	.960	.143	Silver	Gold (C)	1101031A003-012	I/01
14	1	1.41	.500	Nickel	Silver	1101025N003-000	F/02

⁽¹⁾ Brass body and coupling nut.

⁽²⁾ Stainless steel body and coupling nut.

- See page 209 for cable groups.
- Assembly procedures start on page 210.
- ***Contact factory for cable assembly instructions.
- (C) in contact plating column indicates captive contact.
- See page 6 for alternate body plating information.

Right Angle Plug - Military Clamp For Flexible Cable

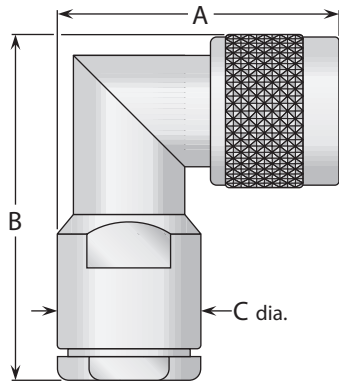

Figure 1
(Mitered body)

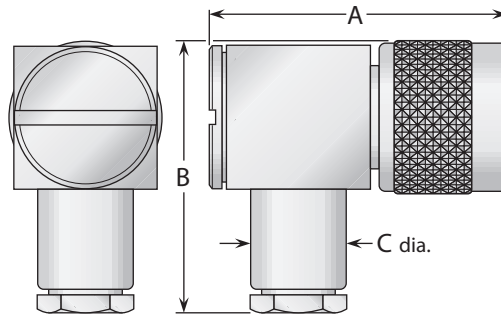

Figure 2
(Cube body with access cap)

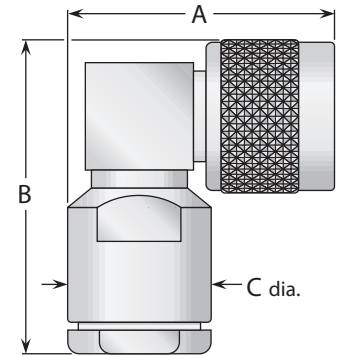

Figure 3
(Cube body)

Cable Group	Figure	Dimensions			Plating		Delta P/N	Assembly Procedure/ Trim Code
		A	B	C	Body	Contact		
2, 3	1	1.47	1.88	.750	Nickel	Silver (C)	UG-594B/U	A/01
2, 3	3	1.36	1.66	.750	Silver	Gold (C)	M39012/05-0101	A/07
2, 3	3	1.39	1.66	.750	Nickel	Gold	1105004N000-000	A/04
5	3	1.39	2.00	.750	Nickel	Gold (C)	1104032N001-000	A/08
5, 6	2	1.55	1.28	.500	Nickel	Silver (C)	1105015N000-000	A/11
5, 6	3	1.35	1.55	.560	Nickel	Silver (C)	1105015N001-000	A/09
7	2	1.55	1.28	.500	Nickel	Silver (C)	1105021N000-000	A/11
9	2	1.55	1.28	.500	Nickel	Silver (C)	1105036N001-000	A/11
19	3	1.36	1.66	.750	Nickel	Silver (C)	1104027N001-000	A/07

Right Angle Plug - Crimp For Flexible Cable

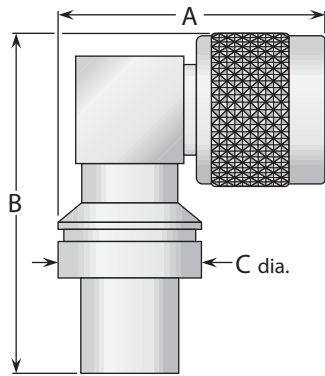

Figure 1
(Cube body)

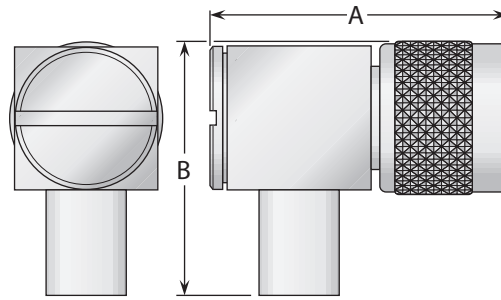

Figure 2
(Cube body with access cap)

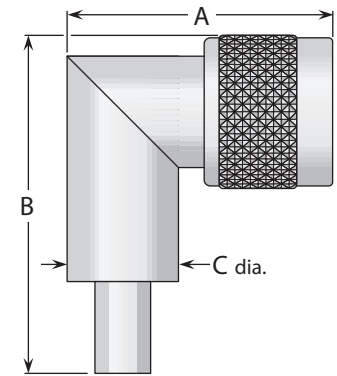

Figure 3
(Mitered body)

Cable Group	Figure	Dimensions			Plating		Delta P/N	Assembly Procedure/ Trim Code
		A	B	C	Body	Contact		
2	1	1.39	1.77	.750	Nickel	Silver	1107002N000-000	B/07
2	2	1.39	1.25	—	Nickel	Silver (C)	1107002N000-001	B/09
3	1	1.39	1.77	.750	Nickel	Silver	1107005N000-000	B/07
2	3	1.41	2.30	.687	Nickel	Gold (C)	1107002N001-002	B/30
3	3	1.41	2.30	.687	Nickel	Gold (C)	1107004N001-002	B/30
6	3	1.41	2.25	.687	Nickel	Gold (C)	1107034N001-001	B/08

- See page 209 for cable groups.
- Assembly procedures start on page 210.
- (C) in contact plating column indicates captive contact.
- See page 6 for alternate body plating information.

Tee Plug - For Flexible & Semi-Rigid Cable

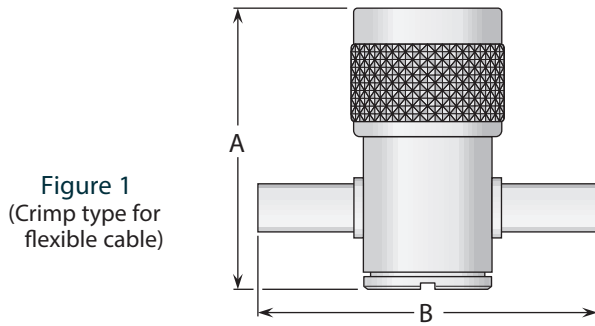

Figure 1
(Crimp type for flexible cable)

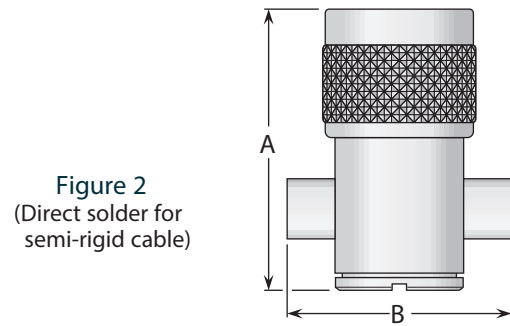

Figure 2
(Direct solder for semi-rigid cable)

Cable Group	Figure	Dimensions		Plating		Delta P/N	Assembly Procedure/ Trim Code
		A	B	Body	Contact		
2	1	1.39	2.00	Silver	Silver (C)	1185002A000-000	B/16
3	1	1.39	2.00	Silver	Silver (C)	1185004A000-002	B/16
6	1	1.39	1.82	Silver	Silver (C)	1185013A001-000	B/17
7	1	1.39	1.82	Silver	Silver (C)	1185019A000-000	B/17
9	1	1.39	1.82	Silver	Silver (C)	1185036A000-000	B/17
13	2	1.39	.900	Silver	Silver (C)	1185031A000-000	***

Straight Jack - Military Clamp For Flexible Cable

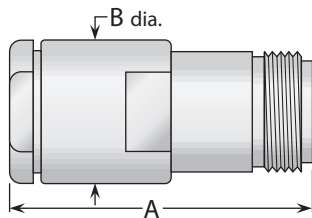

Figure 1

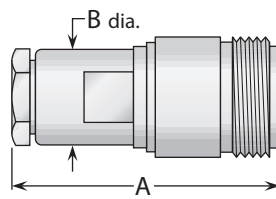

Figure 2

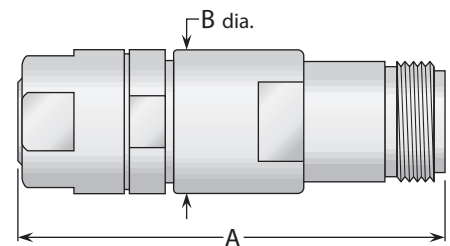

Figure 3
(Includes armor clamp)

Cable Group	Figure	Dimensions		Plating		Delta P/N	Assembly Procedure/ Trim Code
		A	B	Body	Contact		
1	1	1.56	.750	Nickel	Silver	UG-20E/U	A/01
1	1	1.67	.750	Silver	Gold (C)	M39012/02-0101	A/01
2, 3	1	1.56	.750	Nickel	Silver	UG-23D/U	A/01
2, 3	1	1.56	.750	Nickel	Gold	UG-23F/U	A/01
2, 3	1	1.56	.750	Nickel	Silver (C)	UG-1186/U	A/01
2, 3	1	1.56	.750	Nickel	Silver (C)	UG-1186A/U	A/01
2, 3	1	1.67	.750	Silver	Gold (C)	M39012/02-0003	A/01
5, 6	2	1.41	.500	Nickel	Silver	1108015N000-000	A/05
5, 6	2	1.47	.500	Nickel	Silver (C)	1108015N001-000	A/02
7	2	1.41	.500	Nickel	Silver	UG-602A/U	A/02
7	2	1.27	.500	Nickel	Silver	1108000N000-003 *	—
7	2	1.47	.500	Nickel	Silver (C)	1108021N001-000	A/02
15	3	2.25	.750	Nickel	Silver	UG-940B/U	D/03
19	1	1.56	.750	Nickel	Gold (C)	1108027N001-000	A/12
22	1	1.87	.690	Nickel	Gold	1108123N000-000	C/03

*UG-602A/U less clamping hardware.

- See page 209 for cable groups.
- Assembly procedures start on page 210.
- ***Contact factory for cable assembly instructions.
- (C) in contact plating column indicates captive contact.
- See page 6 for alternate body plating information.

Straight Jack - Crimp Type For Flexible Cable

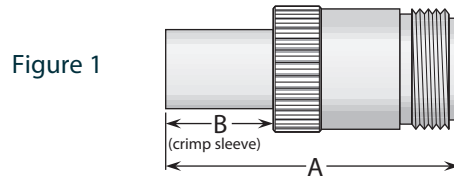

Cable Group	Figure	Dimensions		Plating		Delta P/N	Assembly Procedure/ Trim Code
		A	B	Body	Contact		
2	1	1.64	.600	Silver	Gold (C)	M39012/02B0008	B/10
2	1	1.64	.600	Silver	Gold (C)	M39012/02-0502	B/03
2	1	1.47	.500	Nickel	Gold	1110002N000-000	B/10
2	1	1.60	.630	Nickel	Gold (C)	1110002N001-000	B/11
3	1	1.64	.600	Silver	Gold (C)	M39012/02B0009	B/10
3	1	1.64	.600	Silver	Gold (C)	M39012/02-0501	B/03
3	1	1.47	.500	Nickel	Gold	1110005N000-000	B/10
3	1	1.60	.630	Nickel	Gold (C)	1110005N001-000	B/10
6	1	1.56	.500	Nickel	Gold	1110013N000-001	B/12
6	1	1.54	.500	Silver	Gold (C)	M39012/02-0503	B/03

Straight Jack - Heli-Grip® For Flexible Cable

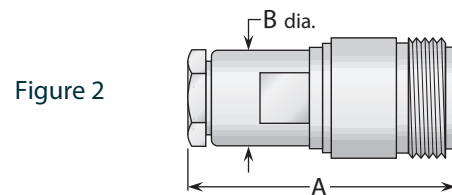
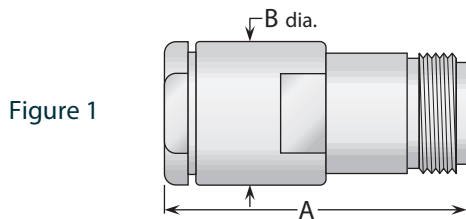

Cable Group	Figure	Dimensions		Plating		Delta P/N	Assembly Procedure/ Trim Code
		A	B	Body	Contact		
2, 3	1	1.63	.750	Nickel	Gold (C)	1108004N005-002	E/01
5, 6 [§]	2	1.41	.500	Nickel	Gold (C)	1108018N005-002	E/02
RG-223	2	1.41	.500	Nickel	Gold (C)	1108015N005-000	E/02
7	2	1.41	.500	Nickel	Gold (C)	1108019N005-002	E/02
8	2	1.41	.500	Nickel	Gold (C)	1108029N005-001	E/02
9	2	1.41	.500	Nickel	Gold (C)	1108037N005-002	E/02

[§]Except RG-223/U.

Straight Jack - For Semi-Rigid Cable

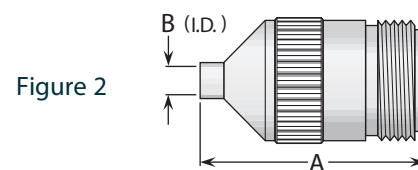
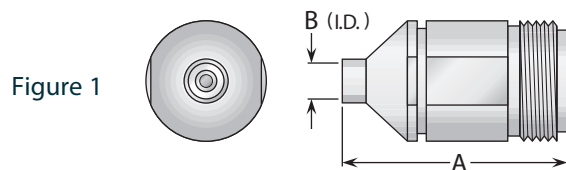

Cable Group	Figure	Dimensions		Plating		Delta P/N	Assembly Procedure/ Trim Code
		A	B	Body	Contact		
12	1	1.07	.254	Silver	Gold	1108050A003-003	***
13	2	1.00	.143	Silver	Gold	1108031A003-000	***

- See page 209 for cable groups.
- Assembly procedures start on page 210.
- ***Contact factory for cable assembly instructions.
- (C) in contact plating column indicates captive contact.
- See page 6 for alternate body plating information.

Bulkhead Jack - Military Clamp For Flexible Cable

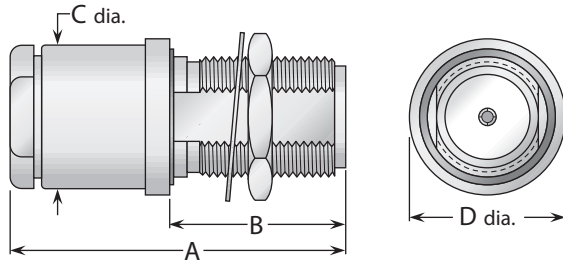

Figure 1
(Rear mount)

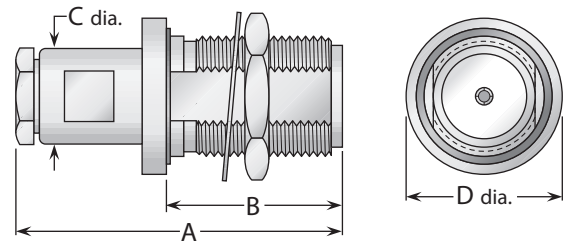
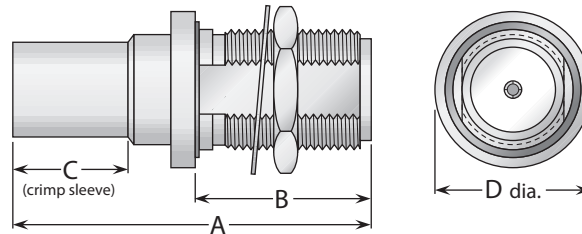

Figure 2
(Rear mount)

Cable Group	Fig.	Dimensions				Mounting Figure	Max. Panel	Plating		Delta P/N	Assembly Procedure/Trim Code
		A	B	C	D			Body	Contact		
1	1	1.75	.920	.750	.900	72	.250	Silver	Gold (C)	M39012/03-0101	A/01
2, 3	1	1.75	.920	.750	.875	72	.250	Nickel	Silver	UG-160D/U	A/01
2, 3	1	1.84	.920	.750	.812	72	.250	Nickel	Silver (C)	1116003N721-000	***
2, 3	1	1.75	.920	.750	.875	72	.250	Nickel	Gold	1116004N720-001	A/01
5, 6	2	1.67	.920	.500	.812	72	.250	Nickel	Silver	UG-556B/U	A/06
5, 6	2	1.67	.920	.500	.875	72	.250	Nickel	Gold (C)	1116015N721-000	A/02
7	2	1.47	.920	.500	.875	72	.250	Nickel	Silver	1116021N720-000	A/14
7	2	1.47	.920	.500	.875	72	.250	Nickel	Gold (C)	1116021N721-000	A/14
9	2	1.48	.920	.500	.875	72	.250	Nickel	Silver (C)	1116036N721-000	A/10
10	2	1.48	.920	.500	.875	72	.250	Nickel	Silver (C)	1116100N721-000	A/10
11	2	1.48	.920	.500	.875	72	.250	Nickel	Silver (C)	1116038N721-000	A/10
16	1	1.90	.920	.880	.875	72	.250	Silver	Gold (C)	M39012/03-0102	A/01

Bulkhead Jack - Crimp Type For Flexible Cable

Figure 1
(Rear mount)



Cable Group	Fig.	Dimensions				Mounting Figure	Max. Panel	Plating		Delta P/N	Assembly Procedure/Trim Code
		A	B	C	D			Body	Contact		
2	1	1.84	.920	.600	.875	72	.250	Silver	Gold (C)	M39012/03B0004	B/03
2	1	1.84	.920	.600	.875	72	.250	Silver	Gold (C)	M39012/03-0502	B/03
3	1	1.84	.920	.600	.875	72	.250	Silver	Gold (C)	M39012/03B0005	B/03
3	1	1.84	.920	.600	.875	72	.250	Silver	Gold (C)	M39012/03-0501	B/03
6	1	1.74	.950	.500	.875	72	.250	Nickel	Gold (C)	1119013N721-000	B/13
6	1	1.74	.920	.500	.875	72	.250	Silver	Gold (C)	M39012/03-0503	B/03
7	1	1.59	.920	.500	.812	72	.250	Nickel	Silver	1119020N720-000	B/14
9	1	1.45	.880	.440	.812	72	.250	Nickel	Silver (C)	1119036N721-000	B/15
10	1	1.45	.880	.440	.812	72	.250	Nickel	Gold (C)	1119100N721-000	B/15

- See page 209 for cable groups.
- Assembly procedures start on page 210.
- ***Contact factory for cable assembly instructions
- See page 208 for mounting dimensions.
- (C) in contact plating column indicates captive contact.
- See page 6 for alternate body plating information.

Bulkhead Jack - Heli-Grip® For Flexible Cable

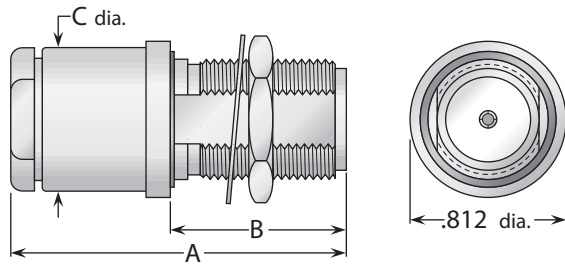

Figure 1

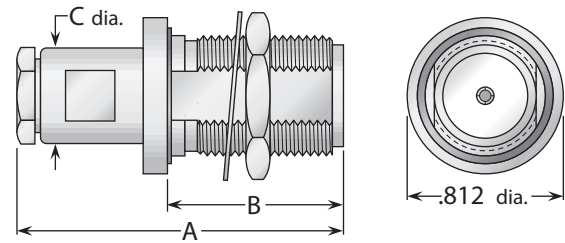
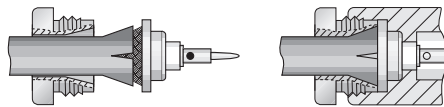

Figure 2

Heli-Grip® Cable Attachment



These connectors have captivated contacts and allow rapid, easy assembly—simply trim the cable, slide into the cone/insulator/contact assembly (left), solder the center conductor to the contact, and screw body assembly (right) onto cable assembly.

Cable Group	Fig.	Dimensions			Mounting Figure	Max. Panel	Plating		Delta P/N	Assembly Procedure/Trim Code
		A	B	C			Body	Contact		
2, 3	1	1.84	.920	.750	72	.250	Nickel	Gold (C)	1116004N725-000	E/01
5, 6 [§]	2	1.69	.920	.500	72	.250	Nickel	Gold (C)	1116015N725-000	E/03
RG-223	2	1.69	.920	.500	72	.250	Nickel	Gold (C)	1116015N725-001	E/03
7	2	1.69	.920	.500	72	.250	Nickel	Gold (C)	1116021N725-000	E/03
10	2	1.69	.920	.500	72	.250	Nickel	Gold (C)	1116100N725-000	E/03

[§]Except RG-223/U.

Tee Bulkhead Jack - For Flexible & Semi-Rigid Cable

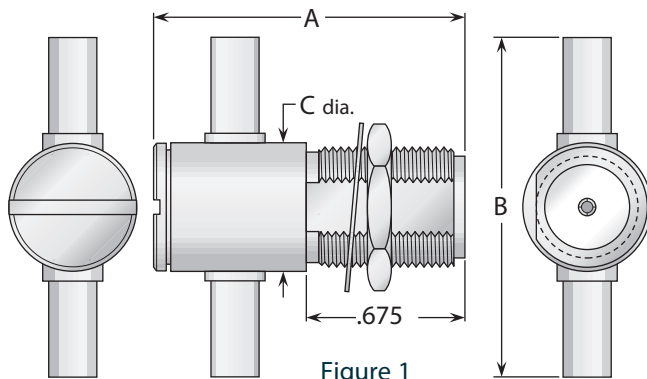

Figure 1
(Crimp type for flexible cable)

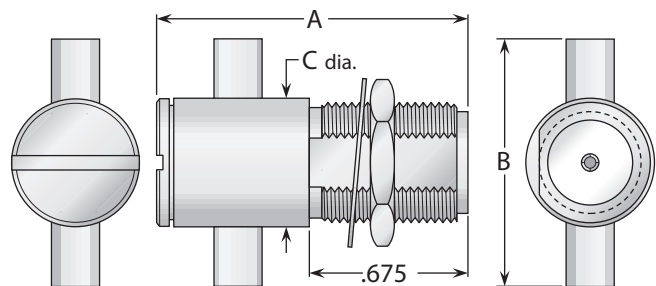

Figure 2
(Direct solder for semi-rigid cable)

Cable Group	Fig.	Dimensions			Mounting Figure	Max. Panel	Plating		Delta P/N	Assembly Procedure/Trim Code
		A	B	C			Body	Contact		
2	1	1.40	2.00	.750	55	.100	Silver	Silver (C)	1185002A551-000	B/16
3	1	1.40	2.00	.750	55	.100	Silver	Silver (C)	1185004A551-000	B/16
6	1	1.38	1.89	.750	55	.100	Silver	Silver (C)	1185013A551-000	B/17
7	1	1.38	1.89	.750	55	.100	Silver	Silver (C)	1185019A551-000	B/17
9	1	1.38	1.89	.750	55	.100	Silver	Silver (C)	1185036A551-000	B/17
13	2	1.38	.900	.750	55	.100	Silver	Silver (C)	1185031A551-000	***

- See page 209 for cable groups.
- Assembly procedures start on page 210.
- *** Contact factory for cable assembly instructions.
- See page 208 for mounting dimensions.
- (C) in contact plating column indicates captive contact.
- See page 6 for alternate body plating information.

Bulkhead Jack - For Semi-Rigid Cable

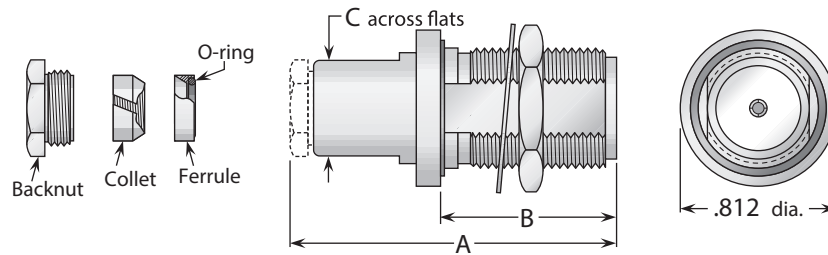

Figure 1
(Collet clamp [solderless] cable attachment, captive contact in body)

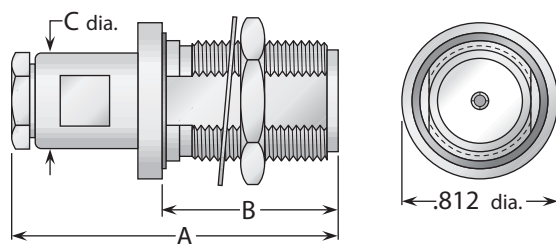

Figure 2
(Solder-clamp; gold-plated ferrule, nickel-plated body)

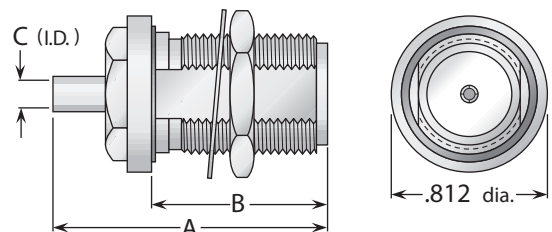
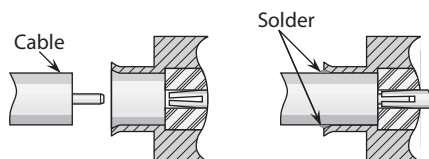

Figure 3
(Direct solder)

Delta One-Step Cable Attachment - For Semi-Rigid Cable

One-Step Cable Attachment



Delta "One-Step" connectors feature captivated contacts and insulators to allow rapid, easy assembly to semi-rigid cable—simply trim the cable jacket and dielectric flush, chamfer the center conductor, insert into the connector, and solder the jacket to the connector body.

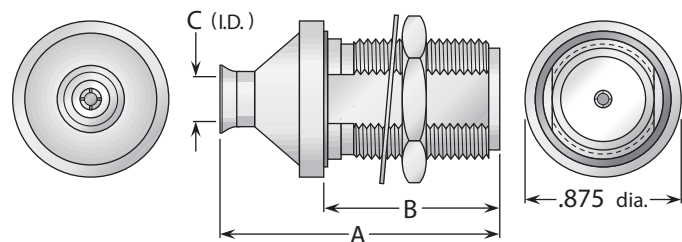

Figure 4
(One-Step cable attachment)

Cable Group	Fig.	Dimensions			Mounting Figure	Max. Panel	Plating		Delta P/N	Assembly Procedure/Trim Code
		A	B	C			Body	Contact		
12	1	1.55	.889	.500	72	.250	Nickel	Gold (C)	1116163N721-000	***
13	2	1.67	.922	.500	72	.250	Nickel	Gold	1116031N720-000	F/04
13	3	1.33	.884	.145	72	.250	Nickel	Gold	1116031N723-001	***
13	4	1.38	.922	.143	72	.250	Silver	Gold (C)	1116031A723-003	I/01
14	2	1.67	.922	.500	72	.250	Nickel	Gold	1116025N723-000	F/04
14	3	1.33	.884	.090	72	.250	Nickel	Gold	1116025N723-001	***
14	4	1.38	.922	.088	72	.250	Silver	Gold (C)	1116025A723-002	I/01

- See page 209 for cable groups.
- Assembly procedures start on page 210.
- *** Contact factory for cable assembly instructions.
- See page 208 for mounting dimensions.
- (C) in contact plating column indicates captive contact.
- See page 6 for alternate body plating information.

Panel Jack - For Flexible Cable

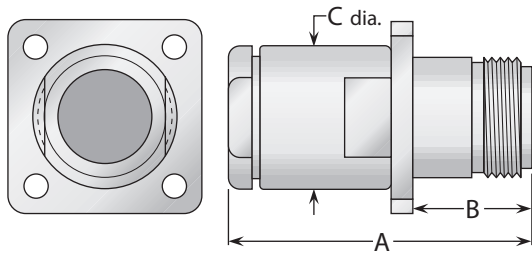

Figure 1

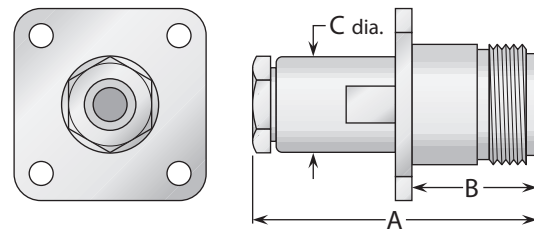
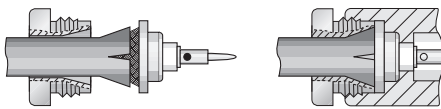

Figure 2

Heli-Grip® Cable Attachment (where noted)



These connectors have captivated contacts and allow rapid, easy assembly—simply trim the cable, slide into the cone/insulator/contact assembly (left), solder the center conductor to the contact, and screw body assembly (right) onto cable assembly.

Military Clamp For Flexible Cable

Cable Group	Fig.	Dimensions			Mounting Figure	Plating		Delta P/N	Assembly Procedure/Trim Code
		A	B	C		Body	Contact		
1	1	1.67	.660	.750	33	Silver	Gold (C)	M39012/02-0104	A/01
2, 3	1	1.58	.660	.750	33	Nickel	Silver	UG-22D/U	A/01
2, 3	1	1.58	.660	.750	33	Nickel	Gold	UG-22F/U	A/01
2, 3	1	1.58	.660	.750	33	Nickel	Silver (C)	UG-1187/U	A/01
2, 3	1	1.58	.660	.750	33	Nickel	Silver (C)	UG-1187A/U	A/01
2, 3	1	1.67	.660	.750	33	Silver	Gold (C)	M39012/02-0006	A/01
5, 6	2	1.41	.660	.500	33	Nickel	Silver	UG-1095B/U	A/13
5, 6	2	1.41	.660	.500	33	Nickel	Gold	UG-1095C/U	A/13
5, 6	2	1.41	.660	.500	27	Nickel	Silver	1111015N270-000	A/13
5, 6	2	1.48	.660	.500	27	Nickel	Gold (C)	1111015N271-000	A/02
5, 6	2	1.41	.660	.500	33	Nickel	Silver (C)	1111015N331-000	A/02
7	2	1.41	.660	.500	33	Nickel	Silver	UG-593A/U	A/14
9	2	1.44	.660	.500	33	Nickel	Silver	1111036N330-000	A/16
9	2	1.48	.660	.500	33	Nickel	Silver (C)	1111036N331-000	A/15
19	1	1.56	.660	.750	33	Nickel	Gold (C)	1111027N331-000	A/12
22	1	1.87	.660	.690	30	Nickel	Gold	1111123N300-000	C/03

Heli-Grip For Flexible Cable

Cable Group	Fig.	Dimensions			Mounting Figure	Plating		Delta P/N	Assembly Procedure/Trim Code
		A	B	C		Body	Contact		
2, 3	1	1.58	.660	.750	33	Nickel	Gold (C)	1111004N335-000	E/01
5, 6 [§]	2	1.41	.660	.500	33	Nickel	Gold (C)	1111015N335-000	E/03
RG-223	2	1.41	.920	.500	33	Nickel	Gold (C)	1111015N335-001	E/03
7	2	1.41	.660	.500	33	Nickel	Gold (C)	1111021N335-000	E/03
9	2	1.41	.660	.500	33	Nickel	Gold (C)	1111037N335-001	E/03
10	2	1.41	.660	.500	33	Nickel	Gold (C)	1111100N335-001	E/03

[§]Except RG-223/U.

- See page 209 for cable groups.
- Assembly procedures start on page 210.
- See page 208 for mounting dimensions.
- (C) in contact plating column indicates captive contact.
- See page 6 for alternate body plating information.

Panel Jack - Crimp Type For Flexible Cable

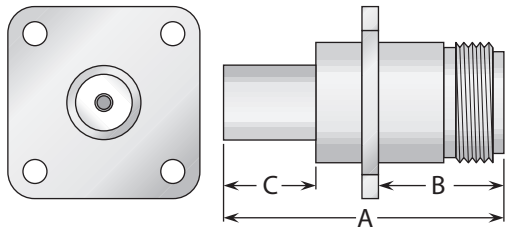

Figure 1 (Standard crimp type)

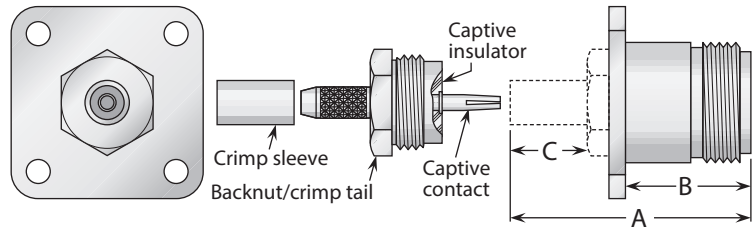

Figure 2 (Contact and insulator captive in backnut)

Cable Group	Fig.	Dimensions			Mounting Figure	Plating		Delta P/N	Assembly Procedure/Trim Code
		A	B	C		Body	Contact		
2	1	1.64	.660	.600	33	Silver	Gold (C)	M39012/02-0512	B/03
3	1	1.64	.660	.600	33	Silver	Gold (C)	M39012/02-0511	B/03
5	2	1.19	.595	.500	33	Nickel	Silver (C)	1155017N331-000	***
6	2	1.19	.595	.500	33	Nickel	Silver (C)	1155013N331-000	***
6	1	1.54	.660	.500	33	Silver	Gold (C)	M39012/02-0513	B/03
9	2	1.16	.595	.380	33	Nickel	Silver (C)	1155037N331-000	***

Panel Jack - For Semi-Rigid Cable

Figure 1
(Solder-clamp; gold-plated ferrule, nickel-plated body)

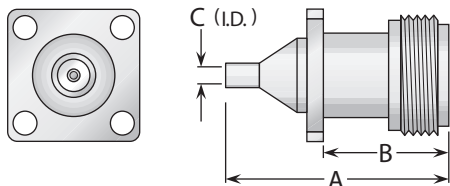
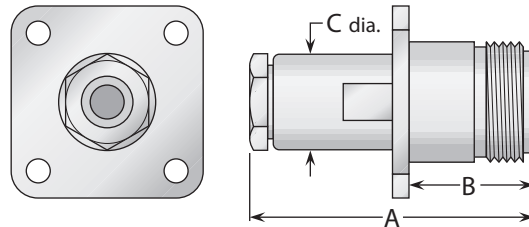

Figure 2 (One-Step cable attachment—see page 76 for details)

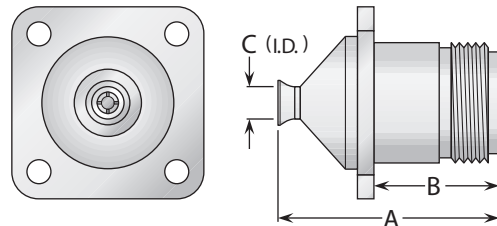

Figure 3 (One-Step cable attachment—see page 76 for details)

Cable Group	Fig.	Dimensions			Mounting Figure	Plating		Delta P/N	Assembly Procedure/Trim Code
		A	B	C		Body	Contact		
13	1	1.41	.660	.500	33	Nickel	Gold	1111031N333-001	F/05
13	2	1.11	.660	.143	09	Silver	Gold (C)	1111031A091-001	I/01
13	3	1.07	.640	.143	33	Silver	Gold (C)	1111031A333-004	I/01
14	1	1.41	.660	.500	33	Nickel	Gold	1111025N333-000	F/05
14	2	1.11	.660	.088	09	Silver	Gold (C)	1111025A091-001	I/01
14	3	1.07	.640	.088	33	Silver	Gold (C)	1111025A333-002	I/01

- See page 209 for cable groups. • Assembly procedures start on page 210.
- *** Contact factory for cable assembly instructions. • See page 208 for mounting dimensions.
- (C) in contact plating column indicates captive contact. • See page 6 for alternate body plating information.

Panel Jack Receptacle - Solder Pot Contact

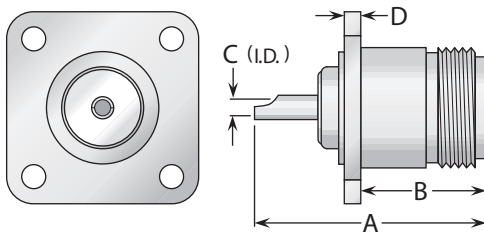

Figure 1

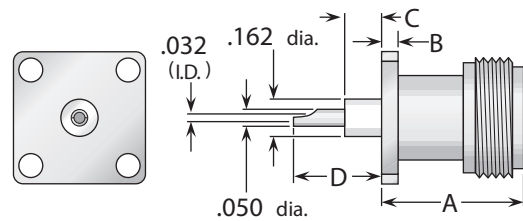

Figure 2
(1¹/₁₆" square flange, interchangeable with BNC and TNC standard flange size)

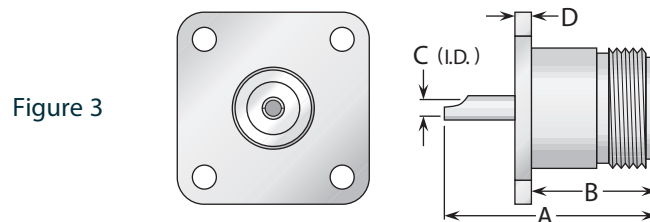

Figure 3

Figure	Dimensions				Mounting Figure	Plating		Delta P/N
	A	B	C	D		Body	Contact	
1	1.13	.660	.100	.080	33	Nickel	Silver (C)	UG-58A/U
1	1.13	.660	.100	.080	33	Silver	Gold (C)	M39012/04-0002
1	1.13	.660	.100	.050	18	Nickel	Silver (C)	1113000N181-000
1	1.13	.660	.100	.080	32A	Nickel	Silver (C)	1113000N321-002
1	1.13	.660	.100	.080	32	Nickel	Gold (C)	1113000N321-003
1	1.13	.660	.100	.080	33	Silver	Gold (C)	1113000A331-011
1	1.13	.660	.100	.080	33	Nickel	Gold (C)	1113000N331-011
1	1.13	.660	.100	.080	95	Nickel	Silver (C)	1113000N951-000
2	.735	.075	.125	.250	09	Nickel	Silver (C)	1113000N091-002
3	1.13	.660	.100	.080	33	Nickel	Gold (C)	1113000N331-009

Panel Jack Receptacle - Solder Pot Contact

Round Flange (For Solder Or Setscrew Mounting)

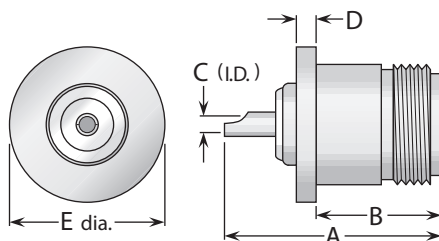

Figure 1

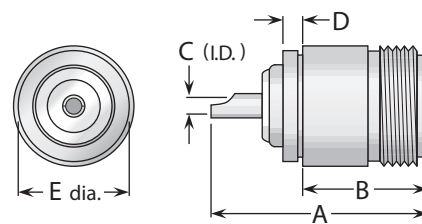

Figure 2

Figure	Dimensions					Plating		Delta P/N
	A	B	C	D	E	Body	Contact	
1	1.25	.660	.100	.175	1.50	Nickel	Silver (C)	1113000N911-002
1	1.25	.660	.100	.125	1.25	Nickel	Gold (C)	1113000N911-005
2	1.13	.660	.100	.110	.575	Nickel	Silver (C)	1120000N831-000

- (C) in contact plating column indicates captive contact.
- See page 208 for mounting dimensions.
- See page 6 for alternate body plating information.
- All items are available with other flange sizes and contact configurations.

Panel Jack Receptacle - Slotted Contact

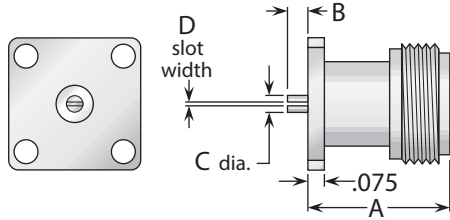

Figure 1
(11/16" square flange, interchangeable with BNC and TNC standard flange size)

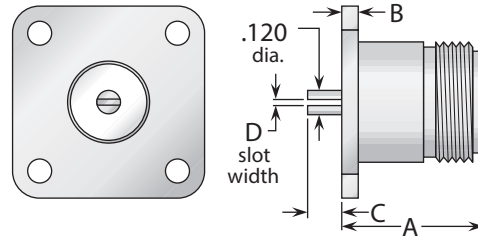

Figure 2

Figure	Dimensions				Mounting Figure	Plating		Delta P/N
	A	B	C	D		Body	Contact	
1	.735	.050	.086	.012/.017	09	Nickel	Gold (C)*	1143000N091-002
1	.735	.050	.086	.036	09	Nickel	Gold (C)*	1143000N091-003
1	.735	.050	.086	.007/.012	09	Nickel	Gold (C)*	1143000N091-004
1	.735	.050	.050	.012/.017	09	Nickel	Gold (C)*	1143000N091-009
2	.736	.080	.050	.012/.017	33	Nickel	Gold (C)*	1143000N330-010
2	.736	.080	.050	.026/.030	33	Nickel	Gold (C)*	1143000N331-017
2	.736	.080	.050	.020/.025	33	Nickel	Gold (C)	1143000N331-023
2	.735	.080	.050	.026/.030	33	Nickel	Gold (C)	1143000N331-054
2	.736	.080	.050	.012/.017	33	Nickel	Gold (C)	1143000N331-055

*Epoxy-captivated contact.

Panel Jack Receptacle - Tab Contact

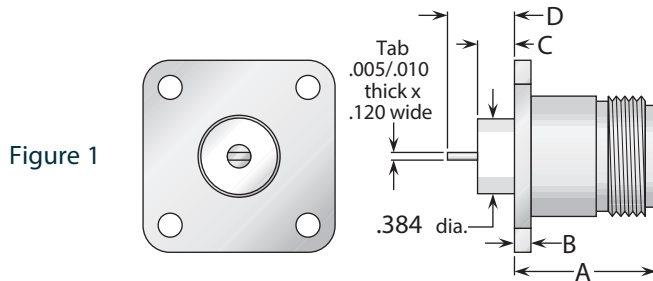

Figure 1

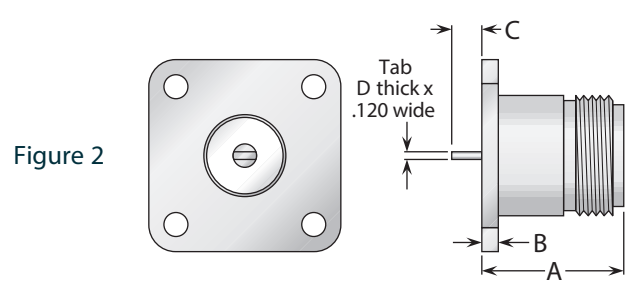

Figure 2

Figure 3
(11/16" square flange, interchangeable with BNC and TNC standard flange size)

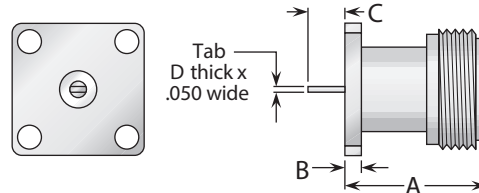

Figure	Dimensions				Mounting Figure	Plating		Delta P/N
	A	B	C	D		Body	Contact	
1	.736	.080	.195	.350	33	Nickel	Gold (C)*	1143000N330-012
2	.736	.080	.100	.005/.008	33	Silver	Gold (C)*	1158000A331-012
3	.735	.075	.050	.004/.006	09	Silver	Gold (C)*	1158000A091-023

*Epoxy-captivated contact.

- (C) in contact plating column indicates captive contact.
- See page 208 for mounting dimensions.
- See page 6 for alternate body plating information.
- All items are available with other flange sizes and contact configurations.

Panel Jack Receptacle - Post Contact

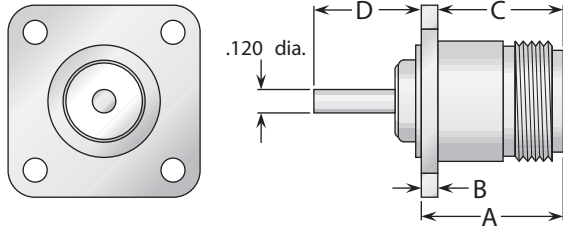

Figure 1

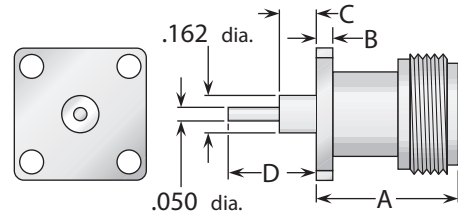

Figure 2

(¹¹/₁₆" square flange, interchangeable with BNC and TNC standard flange size)

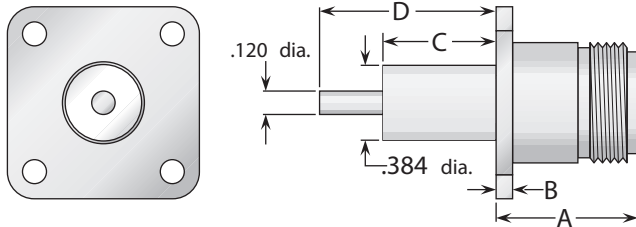

Figure 3

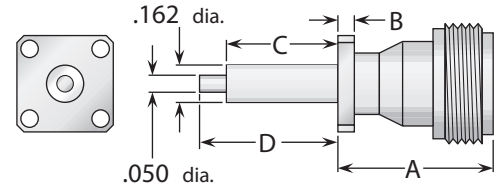

Figure 4

(¹/₂" square flange, interchangeable with SMA standard flange size)

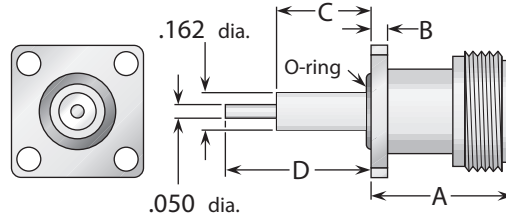

Figure 5

(O-ring seal on flange, ¹¹/₁₆" square flange, interchangeable with BNC and TNC standard flange size)

Figure	Dimensions				Mounting Figure	Plating		Delta P/N
	A	B	C	D		Body	Contact	
1	.736	.080	.660	.560	33	Nickel	Gold (C)	1113000N331-028
2	.735	.075	.125	.250	09	Nickel	Silver (C)	1143000N091-018
2	.735	.075	.125	.250	09	Nickel	Gold (C)	1143000N091-030
2	.735	.075	.590	.705	09	Nickel	Gold (C)*	1143000N091-069
3	.736	.080	.590	.705	33	Nickel	Gold	1143000N330-018
3	.736	.080	.590	.705	33	Nickel	Gold (C)*	1158000N331-015
4	.814	.080	.590	.705	05	Nickel	Gold (C)	1143000N051-002
5	.735	.075	.200	.450	09	Nickel	Gold (C)	1143000N091-059
5	.735	.075	.750	.875	09	Nickel	Gold (C)	1143000N091-073
5	.735	.075	.375	.425	09	Nickel	Gold (C)*	1143000N091-075

*Epoxy-captivated contact.

- (C) in contact plating column indicates captive contact.
- See page 208 for mounting dimensions.
- See page 6 for alternate body plating information.
- All items are available with other flange sizes and contact configurations.

Right Angle Panel Jack Receptacle

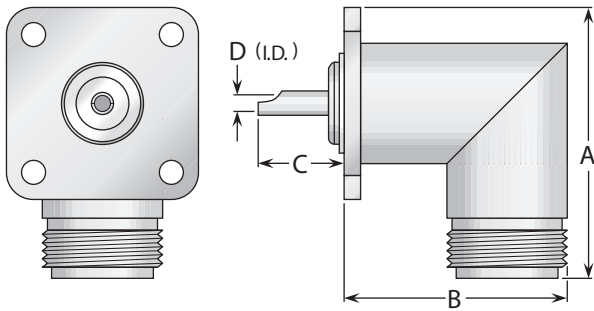

Figure 1

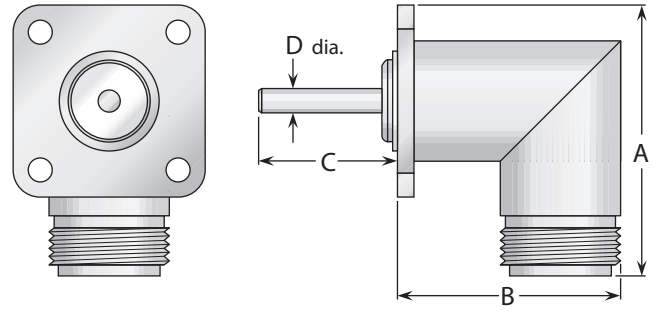

Figure 2

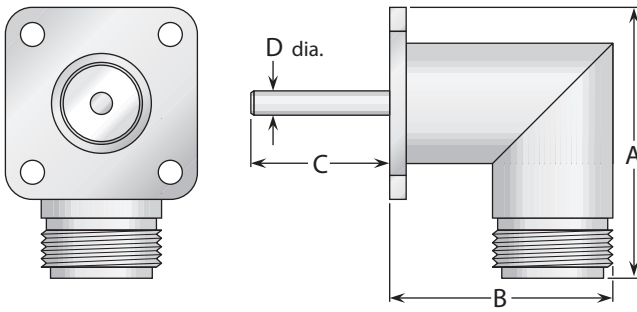

Figure 3

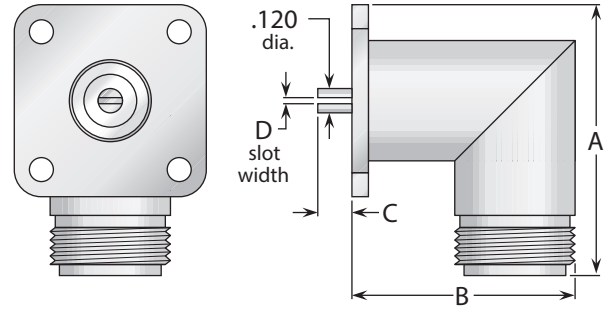
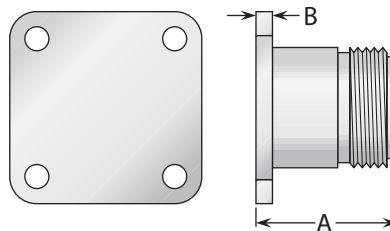

Figure 4

Figure	Dimensions				Mounting Figure	Plating		Delta P/N
	A	B	C	D		Body	Contact	
1	1.41	1.16	.300	.101	33	Nickel	Silver (C)	UG-997A/U
1	1.41	1.16	.300	.101	33	Nickel	Gold (C)	1115000N330-005
2	1.41	1.16	.750	.120	33	Nickel	Silver (C)	1115000N330-009
3	1.41	.830	.560	.120	33	Nickel	Gold (C)	1115000N330-012
4	1.41	1.17	.050	.020/.025	33	Nickel	Silver (C)	1115000N330-011

Dummy Receptacle



Dimensions		Mounting Figure	Plating		Delta P/N
A	B		Body	Contact	
.740	.080	33	Nickel	—	1163000N330-000

- (C) in contact plating column indicates captive contact.
- See page 208 for mounting dimensions.
- See page 6 for alternate body plating information.
- All items are available with other flange sizes and contact configurations.

Panel Plug Receptacles

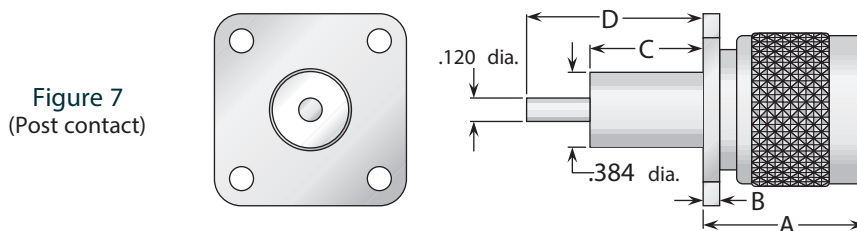
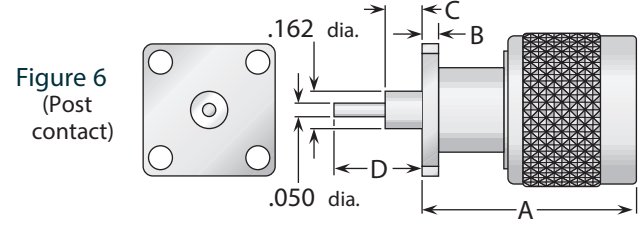
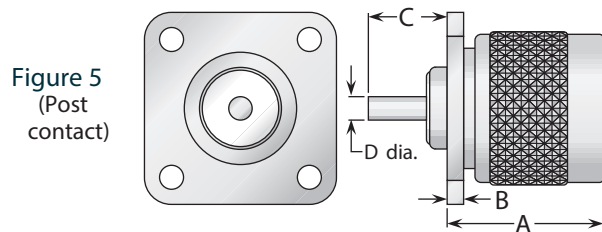
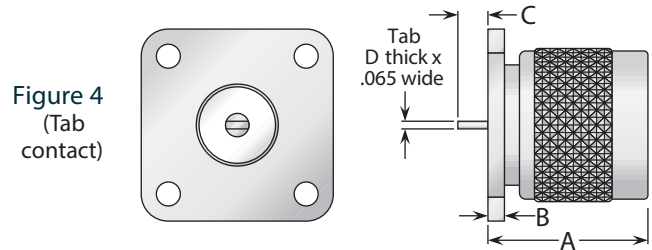
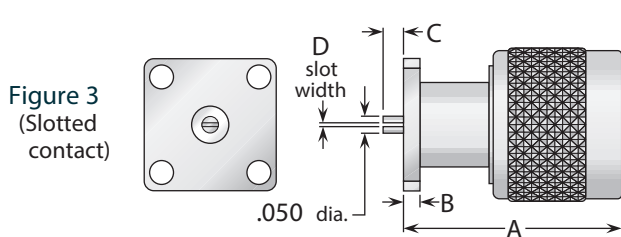
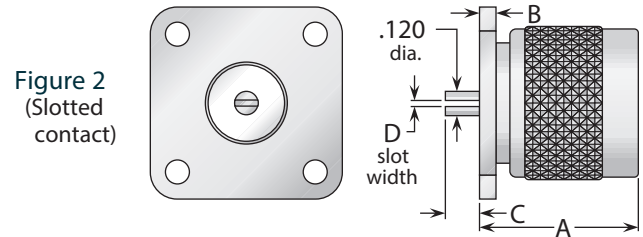
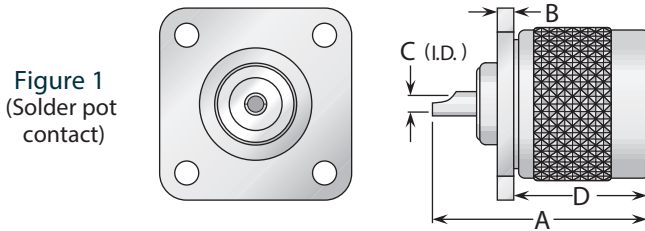

Figure	Dimensions				Mounting Figure	Plating		Delta P/N
	A	B	C	D		Body	Contact	
1	1.10	.080	.101	.720	33	Nickel	Silver (C)	1123000N330-000
1	1.10	.080	.101	.720	33	Nickel	Gold (C)	1123000N330-004
2	.780	.080	.050	.012/.017	33	Nickel	Gold (C)	1159000N330-001
2	.810	.080	.050	.012/.017	33	Nickel	Gold (C)	1159000N330-013
2	.810	.080	.050	.026/.030	33	Nickel	Gold (C)*	1159000N331-026
3	1.17	.075	.050	.020	09	Nickel	Gold (C)*	1159000N091-004
4	.810	.080	.100	.005/.008	33	Nickel	Gold (C)*	1159000N331-009
5	.810	.080	.360	.120	33	Nickel	Gold (C)	1123000N330-002
6	1.17	.075	.125	.250	09	Nickel	Gold (C)	1159000N091-010
7	.810	.080	.590	1.10	33	Nickel	Gold (C)*	1159000N331-006
7	.810	.080	.330	.488	33	Nickel	Gold	1159000N330-011
7	.810	.080	.330	.488	33	Nickel	Gold (C)*	1159000N331-000

*Epoxy-captivated contact.

- (C) in contact plating column indicates captive contact.
- See page 208 for mounting dimensions.
- See page 6 for alternate body plating information.
- All items are available with other flange sizes and contact configurations.

Bulkhead Jack Receptacles

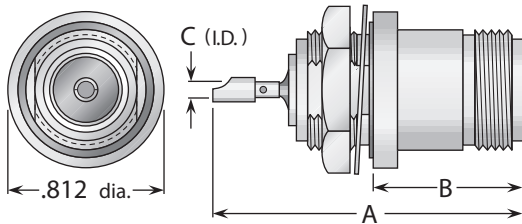

Figure 1
(Front mount, hermetically sealed, with mounting gasket)

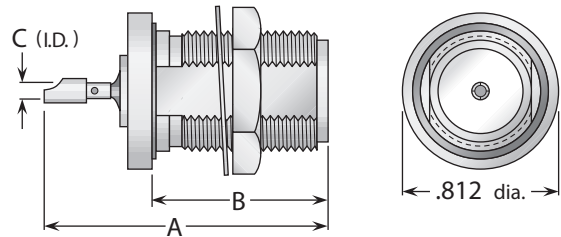

Figure 2
(Rear mount, hermetically sealed, with mounting gasket)

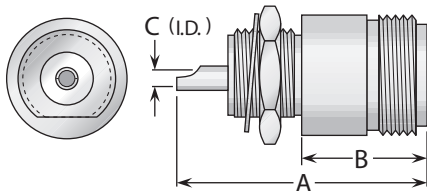

Figure 3
(Front mount, no gasket)

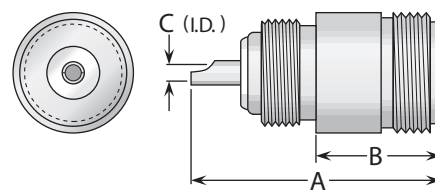

Figure 4
(Front mount, no gasket, screw-in type for 9/16-24 tapped hole)

Figure	Dimensions			Max. Panel	Mounting Figure	Plating		Delta P/N
	A	B	C			Body	Contact	
1	1.62	.707	.099	.100	72	Nickel	Silver (C)	UG-680/U
1	1.62	.707	.099	.100	72	Nickel	Silver (C)	UG-680A/U
1	1.62	.707	.099	.100	72	Silver	Gold (C)	M39012/04-0001
2	1.53	.919	.099	.250	72	Nickel	Silver (C)	1121000N728-005
3	1.25	.606	.099	.100	59	Nickel	Silver (C)	1120000N590-000
3	1.25	.606	.099	.100	59	Nickel	Gold (C)	1120000N590-004
4	1.15	.562	.099	.100	**	Nickel	Silver (C)	1120000N591-000

Stripline Receptacles

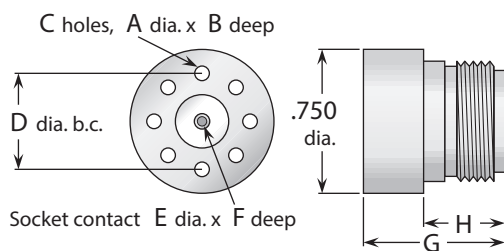

Figure 1

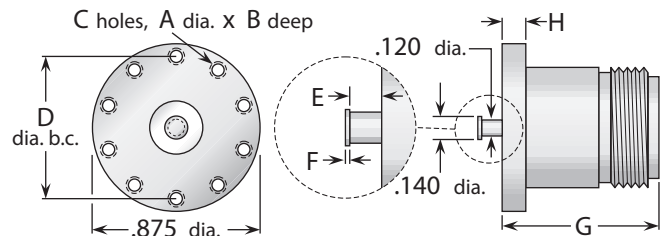

Figure 2

Figure	Dimensions								Plating		Delta P/N
	A	B	C	D	E	F	G	H	Body	Contact	
1	#2-56	.250	7	.560	#0-80	.125	.734	.422	Nickel	Silver	1156000N000-000
1	.078	.313	7	.500	.063	.156	.734	.656	Nickel	Silver	1156000N000-002
1	#2-56	.250	7	.560	#2-56	.125	.734	.422	Nickel	Silver	1156000N000-003
2	#2-56	.125	10	.734	.125	.010	.816	.125	Nickel	Silver	1157000N000-003

- (C) in contact plating column indicates captive contact.
- See page 6 for alternate body plating information.
- See page 208 for mounting dimensions.
- All items are available with other flange sizes and contact configurations.

Press Mount Jack Receptacles

Delta PressMount Receptacles

These connectors eliminate the need for complicated mounting hole patterns and mounting hardware. They are simply pressed into a single through hole, and the precisely-engineered knurled mounting section provides retention strength far greater than normal mating and unmating forces.

An integral shoulder provides a positive stop when mounting.

PressMounts can be used in packages as small as the outer diameter of the connector body.

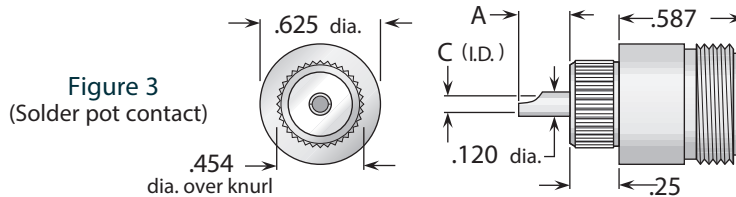
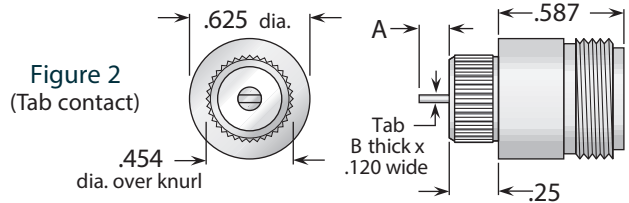
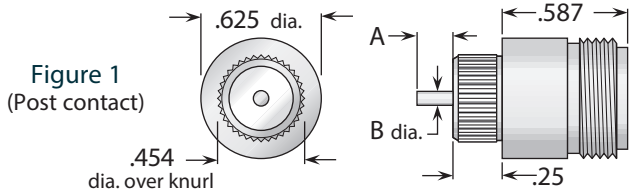
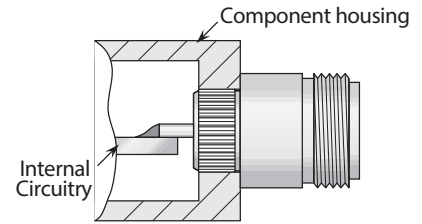

Figure	Dimensions		Min. Panel	Mounting Hole	Plating		Delta P/N
	A	B			Body	Contact	
1	.110	.050	.200	.450 ±.001 dia.	Nickel	Gold (C)	1120000N911-002
2	.100	.005/.008	.200	.450 ±.001 dia.	Nickel	Gold (C)	1120000N911-003
3	.285	.100	.200	.450 ±.001 dia.	Nickel	Gold (C)	1120000N911-004

Press Mount Plug Receptacles

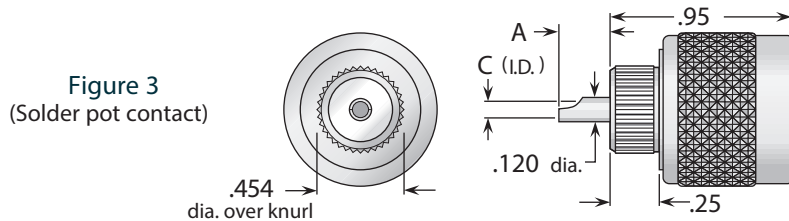
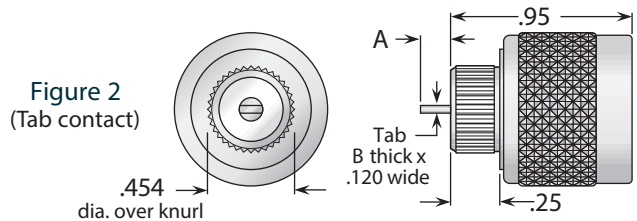
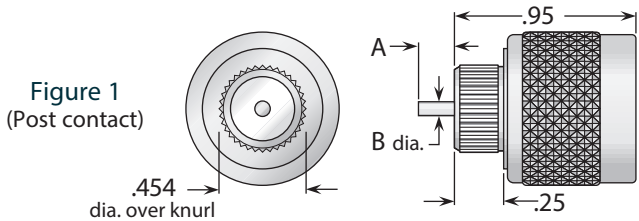
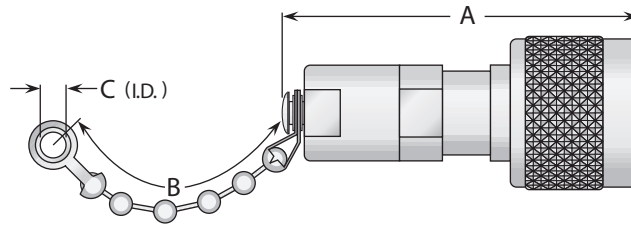

Figure	Dimensions		Min. Panel	Mounting Hole	Plating		Delta P/N
	A	B			Body	Contact	
1	.110	.050	.200	.450 ±.001 dia.	Nickel	Gold (C)	1124000N911-001
2	.100	.005/.008	.200	.450 ±.001 dia.	Nickel	Gold (C)	1124000N911-002
3	.250	.100	.200	.450 ±.001 dia.	Nickel	Gold (C)	1124000N911-000

- (C) in contact plating column indicates captive contact.
- See page 6 for alternate body plating information.
- All items are available with other flange sizes and contact configurations.

Resistive Plug Termination



Resistor	Dimensions			Features	Plating		Delta P/N
	A	B	C		Body	Contact	
50Ω ±1%, 1Watt	1.78	—	—	No chain	Nickel	Silver (C)	1151000N000-003
50Ω ±1%, 1Watt	1.87	5.00	.144		Nickel	Gold (C)	1151000N000-010
51Ω ±5%, 1/2 Watt	1.61	3.50	.144		Nickel	Silver (C)	1131000N000-000
51Ω ±5%, 1/2 Watt	1.67	—	—	No chain	Nickel	Silver (C)	1131000N00A-000
51Ω ±5%, 1 Watt	1.87	3.75	.144		Nickel	Silver (C)	1151000N000-000
75Ω ±1%, 1 Watt	1.87	5.00	.144		Nickel	Gold (C)	1151000N000-011

Dust Caps

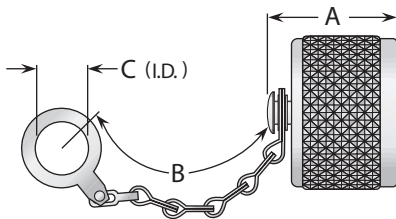

Figure 1
(Shown with safety chain)

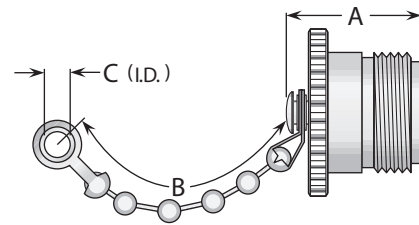

Figure 2
(Shown with bead chain)

Figure	Dimensions			Features	Plating		Delta P/N
	A	B	C		Body	Contact	
1	.560	2.25	.144	Bead chain	Nickel	—	MX-913/U
1	.560	2.50	.144	Bead chain	Silver	—	M39012/25-0011
1	.560	3.75	.635	Safety chain	Silver	—	M39012/25-0012
1	.840	2.50	.170	Bead chain / shorting type	Nickel	Silver (C)	1132000N00C-002
2	.720	3.50	.144	Bead chain	Nickel	—	1133000N000-000
2	.910	2.50	.170	Bead chain / shorting type	Nickel	Silver (C)	1133000N00C-000

- (C) in contact plating column indicates captive contact.
- See page 6 for alternate body plating information.
- Caps and terminations are available with other chain styles and/or resistances.

Bulkhead & Panel Mounted Jack - Jack Adapters (Connect Two Plugs)

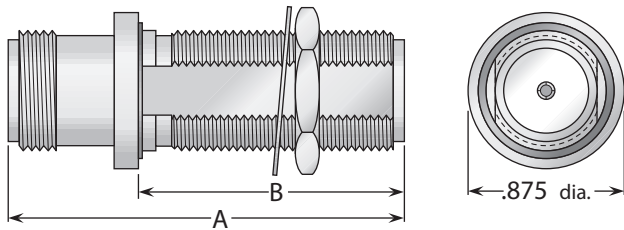

Figure 1
(Bulkhead mount, hermetically sealed)

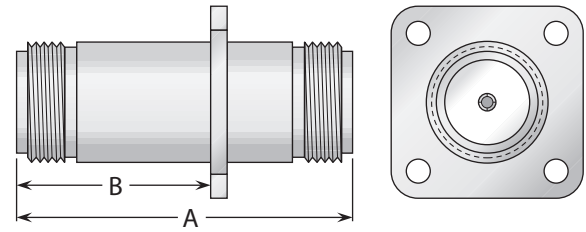

Figure 2
(Panel mount)

Figure	Dimensions		Max. Panel	Mounting Figure	Plating		Delta P/N
	A	B			Body	Contact	
1	1.54	.863	.250	72	Nickel	Silver (C)	UG-30D/U
1	1.54	.863	.250	72	Nickel	Silver (C)	UG-30E/U
1	1.54	.863	.250	72	Silver	Gold (C)	M55339/04-00030
1	2.06	1.375	.750	72	Nickel	Silver (C)	1126000N728-000
2	1.75	1.00	—	33	Nickel	Silver (C)	1125000N330-000

Straight Adapters

Figure 1
(Straight jack-jack;
connects two plugs)

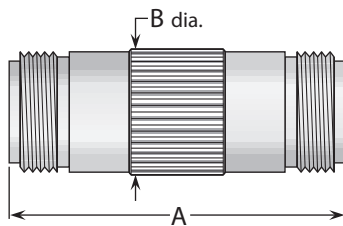

Figure 2
(Straight plug-plug;
connects two jacks)

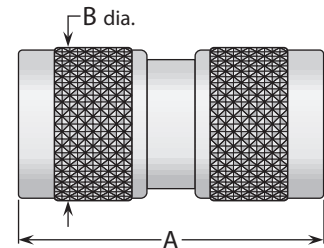

Figure 3
(Straight jack-plug;
connects one plug
and one jack)

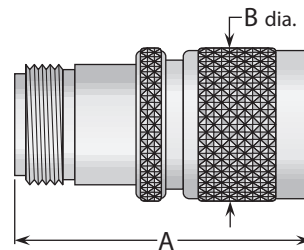

Figure	Dimensions		Plating		Delta P/N
	A	B	Body	Contact	
1	1.75	.660	Nickel	Silver (C)	UG-29B/U
1	1.75	.660	Silver	Gold (C)	M55339/07-00029
2	1.59	.780	Nickel	Silver (C)	UG-57B/U
2	1.59	.780	Silver	Gold (C)	M55339/05-00057 *
3	1.56	.780	Nickel	Silver (C)	1134000N000-000

* Lockwire holes in coupling nut.

(C) in contact plating column indicates captive contact. • See page 208 for mounting dimensions.
See page 6 for alternate body plating information.

Right Angle Adapters

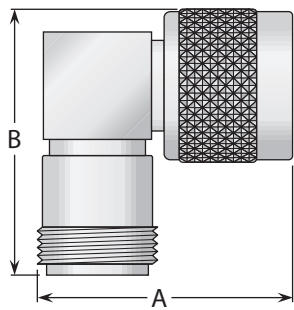

Figure 1
(Right angle plug-jack;
connects one plug
and one jack)

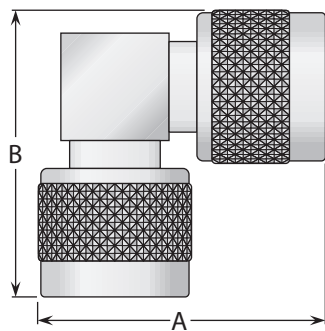

Figure 2
(Right angle plug-plug;
connects two jacks)

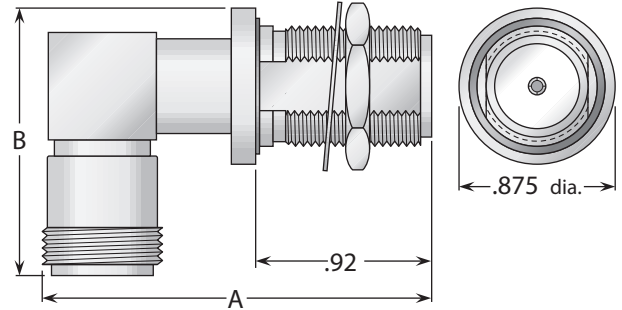

Figure 3
(Bulkhead mounted right angle jack-jack;
connects two plugs)

Figure	Dimensions		Max. Panel	Mounting Figure	Plating		Delta P/N
	A	B			Body	Contact	
1	1.30	1.38	—	—	Nickel	Silver (C)	UG-27C/U
1	1.30	1.38	—	—	Nickel	Gold (C)	UG-27D/U
1	1.30	1.38	—	—	Silver	Gold (C)	M55339/03-00027*
2	1.39	1.39	—	—	Nickel	Silver (C)	1137000N000-000
3	2.13	1.36	.250	72	Nickel	Gold (C)	UG-202A/U

* Lockwire holes in coupling nut.

Tee Adapters

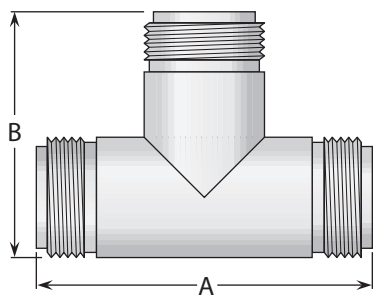

Figure 1
(Tee jack-jack-jack;
connects three plugs)

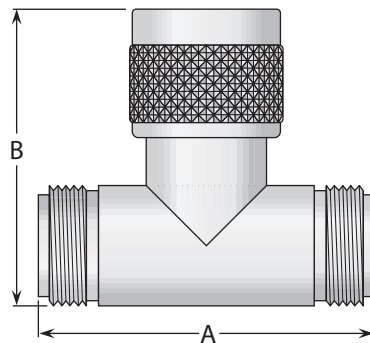

Figure 2
(Tee jack-plug-jack;
connects two plugs and one jack)

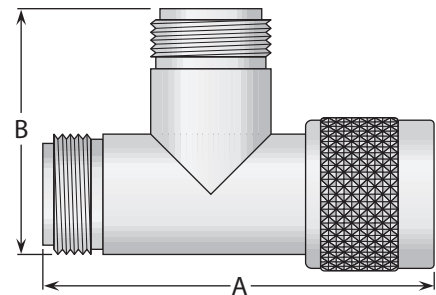

Figure 3
(Tee jack-jack-plug;
connects two plugs and one jack)

Figure	Dimensions		Plating		Delta P/N
	A	B	Body	Contact	
1	1.75	1.22	Nickel	Silver (C)	UG-28A/U
1	1.75	1.22	Silver	Gold (C)	M55339/06-00028
2	1.75	1.47	Nickel	Silver (C)	UG-107B/U
2	1.75	1.47	Silver	Gold (C)	M55339/06-00001
3	2.03	1.22	Nickel	Gold (C)	1149000N001-001

- (C) in contact plating column indicates captive contact.
- See page 208 for mounting dimensions.
- See page 6 for alternate body plating information.

N70 Configurations

Straight Cable Plugs	89	Right Angle Panel Jack Receptacles	90
Straight Cable Jacks	89	Panel Plug Receptacles.....	90
Bulkhead Cable Jacks	89	Bulkhead Jack Receptacles	90
Panel Jack Receptacles (square flange)	90	In-Series Adapters	91

Straight Plug - Military Clamp For Flexible Cable

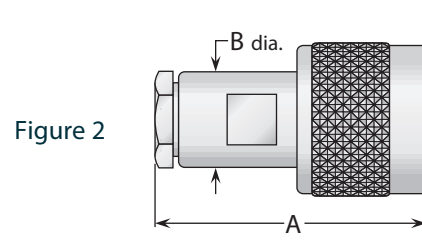
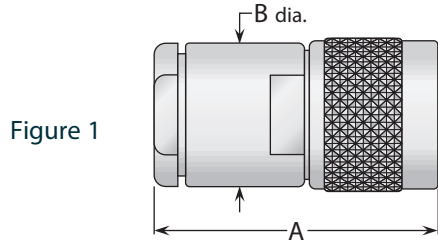

Cable Group	Figure	Dimensions		Plating		Delta P/N	Assembly Procedure/Trim Code
		A	B	Body	Contact		
2B, 3B	1	1.80	.690	Nickel	Silver	UG-94A/U	C/01
7	2	1.38	.500	Nickel	Silver	1801021N000-000	A/02

Straight Jack - Military Clamp For Flexible Cable

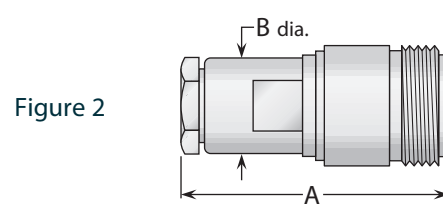
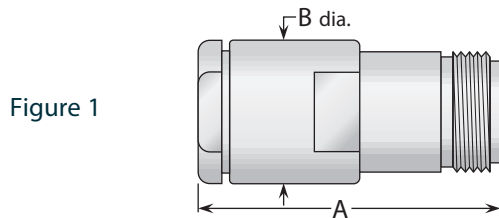

Cable Group	Figure	Dimensions		Plating		Delta P/N	Assembly Procedure/Trim Code
		A	B	Body	Contact		
2B, 3B	1	1.88	.690	Nickel	Gold	UG-95A/U	C/08
7	2	1.41	.500	Nickel	Silver	1808021N000-000	A/02

Bulkhead Jacks - For Flexible Cable

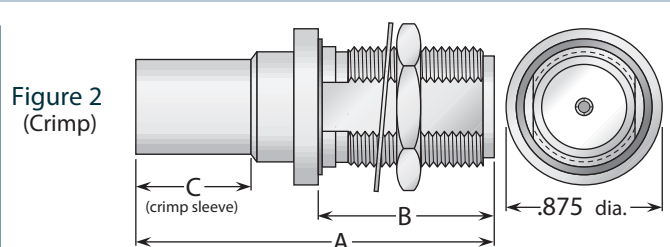
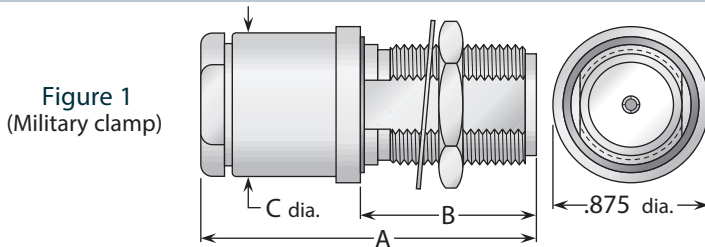

Cable Group	Fig.	Dimensions			Mounting Figure	Max. Panel	Plating		Delta P/N	Assembly Procedure/Trim Code
		A	B	C			Body	Contact		
2B, 3B	1	1.84	.920	.690	72	.250	Nickel	Gold	1816003N720-000	C/08
7	1	1.47	.920	.500	72	.250	Nickel	Silver (C)	1816021N721-000	A/14
2B, 3B	2	1.84	.920	.600	72	.250	Nickel	Gold	1819003N720-000	B/03
7	2	1.59	.920	.500	72	.250	Nickel	Silver	1819020N720-000	B/14

- See page 209 for cable groups.
- Assembly procedures start on page 210.
- See page 208 for mounting dimensions.
- (C) in contact plating column indicates captive contact.
- See page 6 for alternate body plating information.

Panel Receptacle - Solder Pot Contact

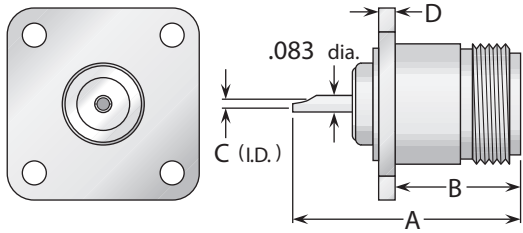

Figure 1
(Straight jack receptacle)

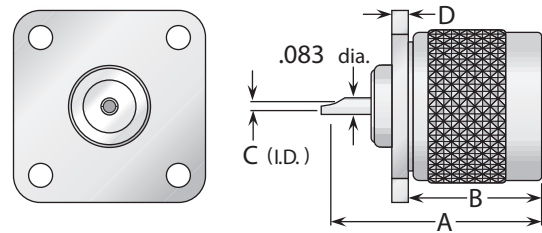

Figure 2
(Straight plug receptacle)

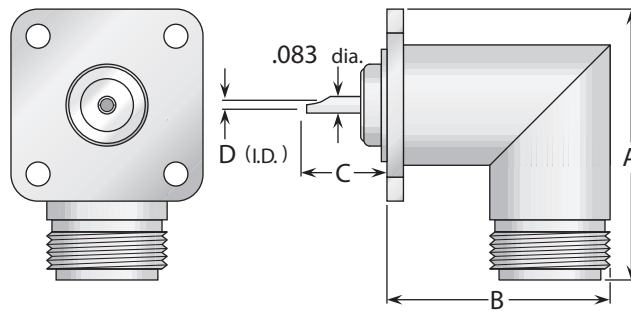

Figure 3
(Right angle jack receptacle)

Figure	Dimensions				Mounting Figure	Plating		Delta P/N
	A	B	C	D		Body	Contact	
1	1.13	.660	.062	.080	33	Nickel	Gold (C)	1813000N331-000
2	1.10	.720	.062	.080	33	Nickel	Silver (C)	1823000N331-001
3	1.41	1.16	.300	.050	33	Nickel	Gold (C)	1815000N330-000

Bulkhead Receptacle - Solder Pot Contact

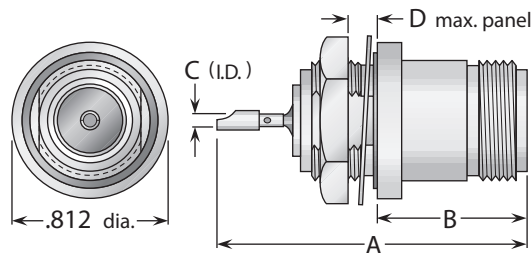

Figure 1
(Front mount, hermetically sealed)

Figure	Dimensions				Mounting Figure	Plating		Delta P/N
	A	B	C	D		Body	Contact	
1	1.62	.707	.099	.250	72	Nickel	Silver (C)	1820000N728-000

- See page 208 for mounting dimensions.
- (C) in contact plating column indicates captive contact.
- See page 6 for alternate body plating information.

Straight Adapters

Figure 1
(Straight jack-jack;
connects two plugs)

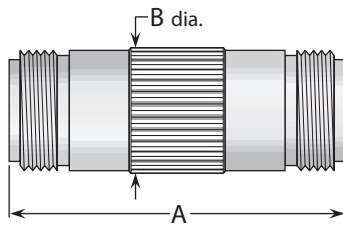

Figure 2
(Straight plug-plug;
connects two jacks)

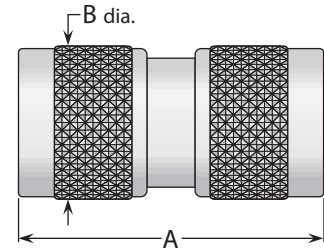

Figure	Dimensions		Plating		Delta P/N
	A	B	Body	Contact	
1	1.75	.660	Nickel	Gold (C)	1828000N000-000
2	1.59	.780	Nickel	Gold (C)	1827000N000-000

Right Angle & Tee Adapters

Figure 1
(Right angle jack-plug;
connects one plug and one jack)

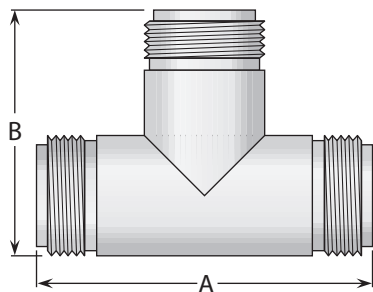
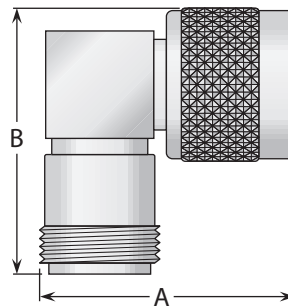

Figure 2
(Tee jack-jack-jack;
connects three plugs)

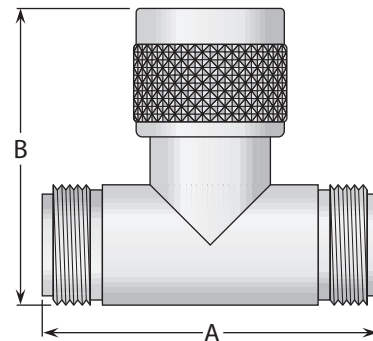

Figure 3
(Tee jack-plug-jack;
connects two plugs and one jack)

Figure	Dimensions		Plating		Delta P/N
	A	B	Body	Contact	
1	1.30	1.38	Nickel	Gold (C)	1829000N000-000
2	1.75	1.22	Nickel	Gold (C)	1838000N000-000
3	1.75	1.47	Nickel	Gold (C)	1830000N000-000

- (C) in contact plating column indicates captive contact.
- See page 6 for alternate body plating information.

General Description

Delta QDS series connectors are medium-size, 50 Ω impedance connectors with positive-locking, push-on coupling and good power handling capability. Because they mate with a straight push and unmate with a straight pull, QDS connectors are ideal for use in applications where the use of a torque wrench for mating is impractical.

As with our other connector series, Delta's customer-driven design results in QDS series connectors with practical and unique features that make your design and assembly process easier. Some of these include:

- Standard Albaloy body plating (see page 6 for details), which has the same low intermodulation distortion as silver plating, with the durability of nickel plating. Note: QDS connectors with UG designations have silver-plated bodies to conform to military specifications, but are available with Albaloy body plating.
- Color bands on plug connectors for positive visual confirmation of proper mating.
- A new series of MiniQDS connectors, similar in size to BNC and TNC connectors, but with the same convenient push-on, positive-locking mating as QDS connectors (see page 66).
- Cable plugs and jacks for armored cables.

Our QDS series product line is still growing, so please call if you don't see what you need.

QDS Configurations

Straight Cable Plugs	93	Panel Jack Receptacles (square flange)	95
Right Angle Cable Plugs	93	Bulkhead Jack Receptacles	95
Bulkhead Cable Jacks	94	Resistive Terminations	96
Panel Cable Jacks	94	Between-Series Adapters	96

QDS Specifications*

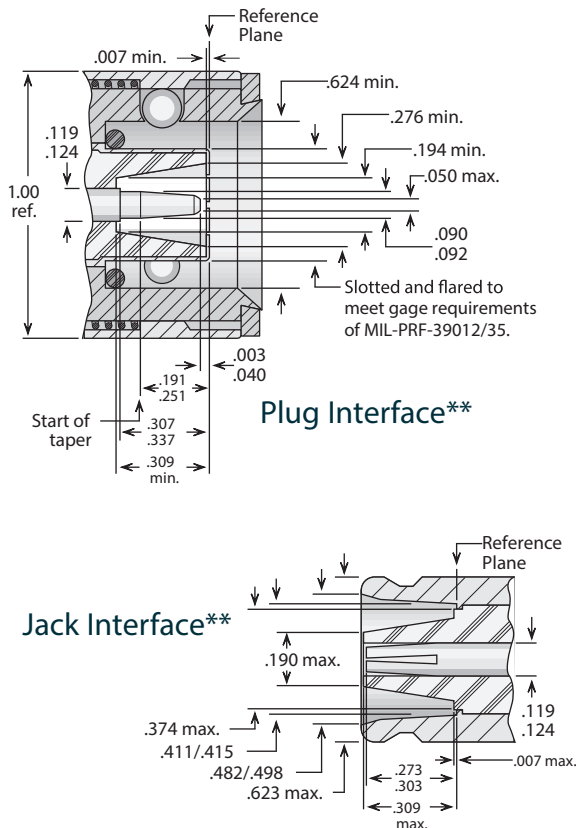

Electrical:

Nominal Impedance: 50 ohms.
 Frequency Range: DC–11 GHz (usable);
 DC–2 GHz (recommended).
 Voltage Rating: 1,000 volts RMS.
 Dielectric Withstanding Voltage : 3,000 VRMS.
 Insulation Resistance: 5,000 megohms.

Materials/Finishes:

Insulators: Teflon per ASTM D1710.
 Male Contacts: Brass per ASTM B16.
 Female Contacts: Beryllium Copper per ASTM B196.
 Contact Plating : Silver per ASTM B700, or Gold per MIL-DTL-45204.
 Gaskets: Silicone rubber per ZZ-R-765, Class II, Grade 50.
 Other Metal Parts: Brass per ASTM B16, plated: Albaloy (contact factory for specifications), or Silver per ASTM B700, or Nickel per AMS-QQ-N-290.

All other specifications are in accordance with the latest issues of MIL-PRF-39012, or MIL-C-18867, or other applicable MIL specifications, and interfaces are in accordance with MIL-STD-348.

*These specifications are typical and may not apply to all connectors. Detailed specifications for individual connectors are available on request.

**Some proportions altered to illustrate detail.

Straight Plug - Military Clamp For Flexible Cable

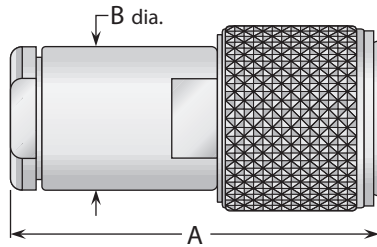

Figure 1

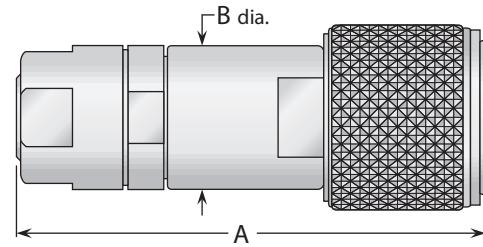

Figure 2
(Includes armor clamp)

Cable Group	Figure	Dimensions		Plating		Delta P/N	Assembly Procedure/ Trim Code
		A	B	Body	Contact		
2, 3	1	1.83	.750	Albaloy	Gold	3801004Q000-001	A/02
5, 6	1	1.83	.750	Albaloy	Gold	3801015Q000-001	A/02
15	2	2.16	.812	Silver	Silver	UG-968B/U	D/04

Right Angle Plug - Military Clamp For Flexible Cable

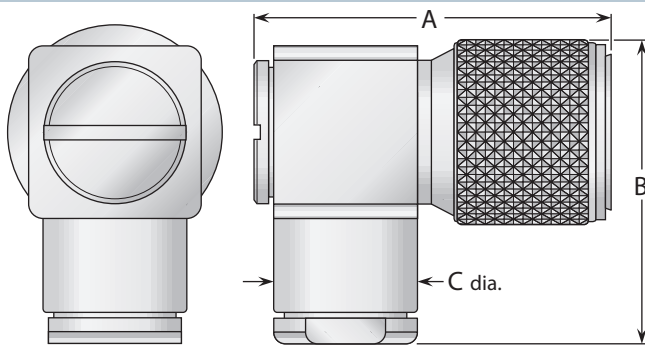

Figure 1

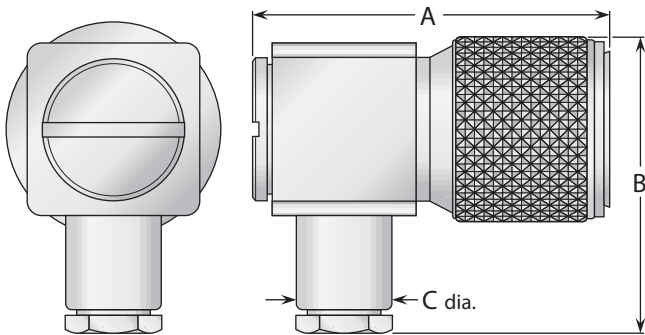

Figure 2

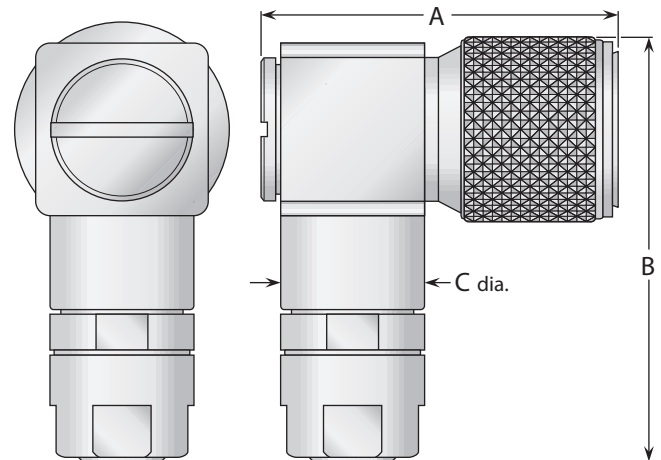
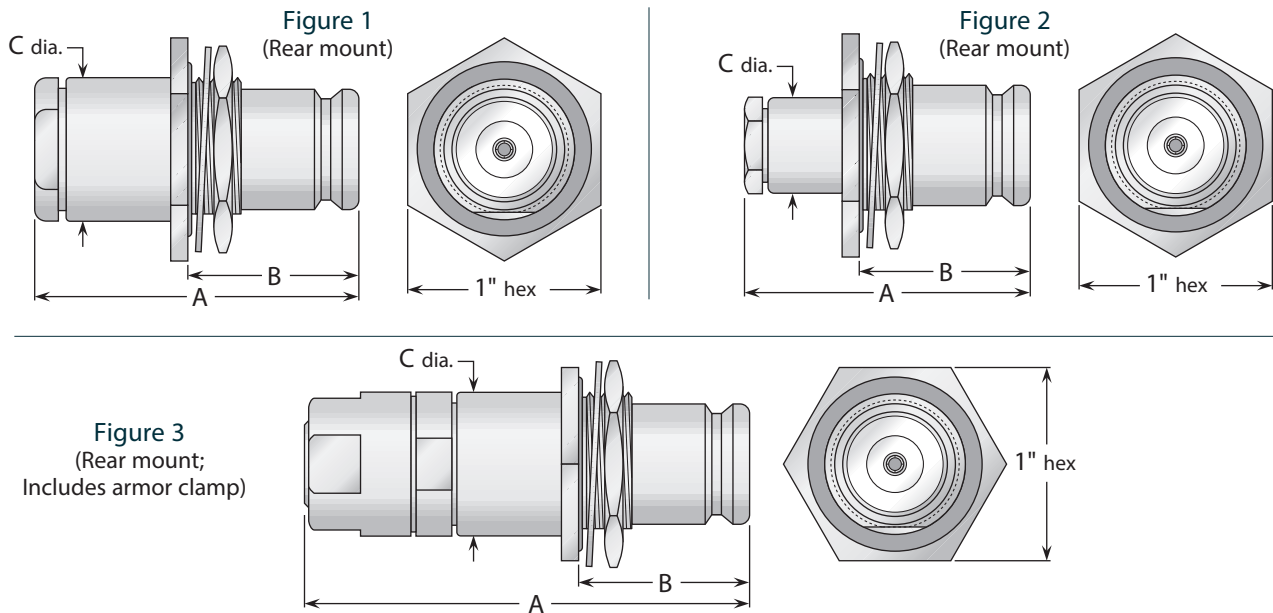

Figure 3
(Includes armor clamp)

Cable Group	Figure	Dimensions			Plating		Delta P/N	Assembly Procedure/ Trim Code
		A	B	C	Body	Contact		
2, 3	1	1.93	1.85	.750	Albaloy	Gold (C)	3805004Q000-000	A/31
5, 6	2	1.93	1.63	.500	Albaloy	Gold (C)	3805015Q000-000	A/30
15	3	1.93	2.40	.812	Albaloy	Gold (C)	3805006Q000-000	***

- See page 209 for cable groups.
- Assembly procedures start on page 210.
- ***Contact factory for cable assembly instructions.
- (C) in contact plating column indicates captive contact.
- See page 6 for alternate body plating information.

Bulkhead Jack - Military Clamp For Flexible Cable



Cable Group	Fig.	Dimensions			Mounting Figure	Max. Panel	Plating		Delta P/N	Assembly Procedure/Trim Code
		A	B	C			Body	Contact		
2, 3	1	1.66	.865	.750	51	.200	Albaloy	Gold (C)	3816004Q511-001	A/01
5, 6	2	1.60	.865	.500	51	.200	Albaloy	Gold (C)	3816015Q511-001	A/25
15	3	2.00	.865	.750	51	.200	Silver	Silver	UG-1132A/U	D/04

Panel Jack - Military Clamp For Flexible Cable

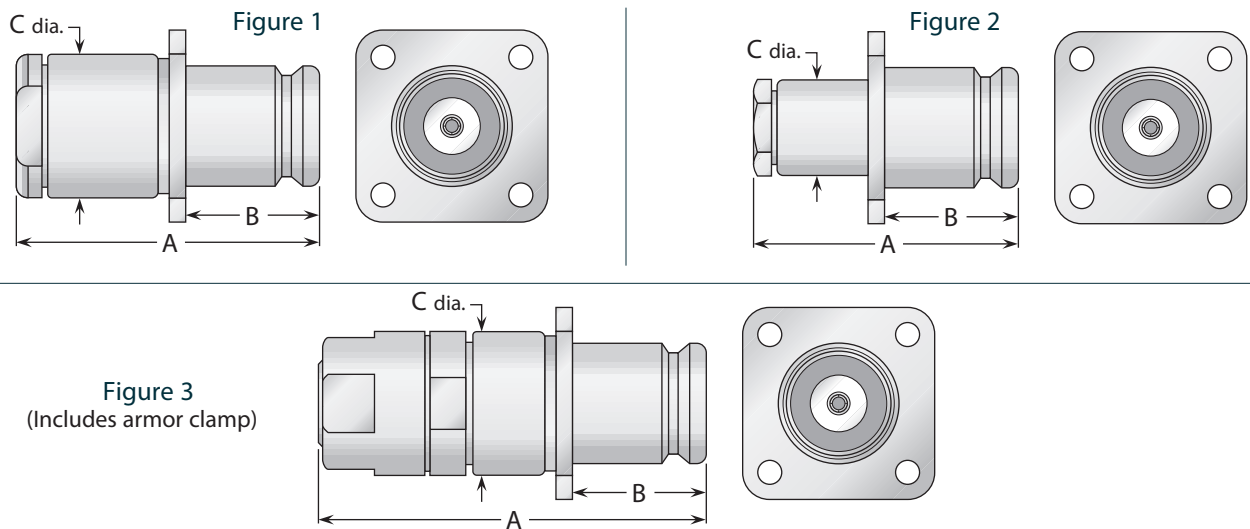

Cable Group	Fig.	Dimensions			Mounting Figure	Plating		Delta P/N	Assembly Procedure/Trim Code
		A	B	C		Body	Contact		
2, 3	1	1.66	.690	.750	33	Albaloy	Gold (C)	3811004Q331-000	A/01
5, 6	2	1.60	.690	.500	33	Albaloy	Gold (C)	3811015Q331-000	A/25
15	3	2.00	.690	.750	33	Silver	Silver	UG-972B/U	D/04

- See page 209 for cable groups.
- Assembly procedures start on page 210.
- See page 208 for mounting dimensions.
- (C) in contact plating column indicates captive contact.
- See page 6 for alternate body plating information.

Panel Jack Receptacles - Square Flange

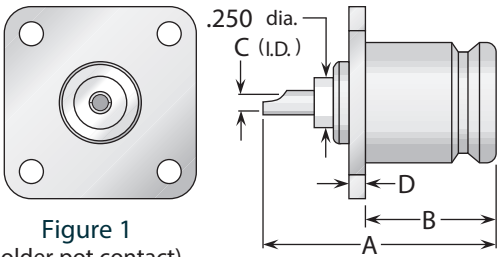

Figure 1
(Solder pot contact)

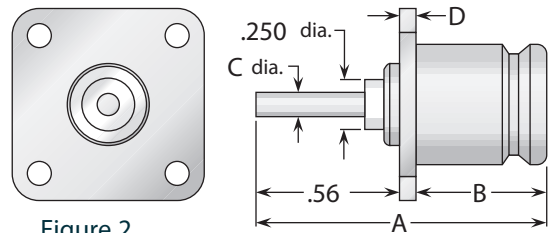

Figure 2
(Post contact)

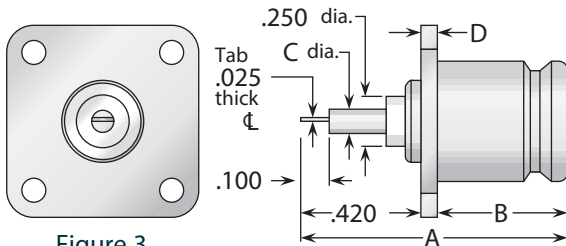

Figure 3
(Tab contact)

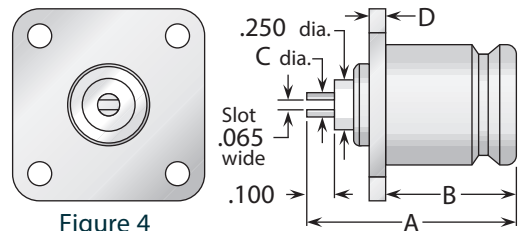

Figure 4
(Slotted contact)

Also available with other contact/insulator configurations and flange sizes

Figure	Dimensions				Mounting Figure	Plating		Delta P/N
	A	B	C	D		Body	Contact	
1	1.08	.670	.106	.080	33	Albaloy	Gold (C)	3813000Q331-000
2	1.31	.670	.120	.080	33	Albaloy	Gold (C)	3858000Q331-001
3	1.17	.670	.120	.080	33	Albaloy	Gold (C)	3858000Q331-003
4	1.00	.670	.120	.080	33	Albaloy	Gold (C)	3858000Q331-002

Bulkhead Jack Receptacles

Figure 1
(Rear mount, with mounting gasket)

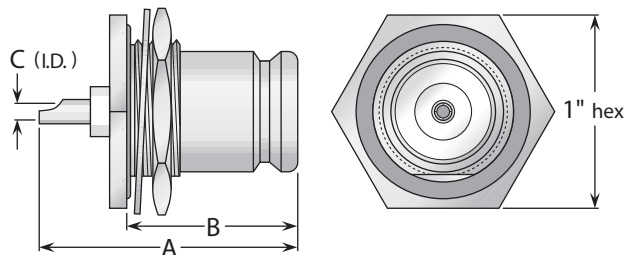

Also available with post, slotted, or tab contact

Figure	Dimensions			Max. Panel	Mounting Figure	Plating		Delta P/N
	A	B	C			Body	Contact	
1	1.08	.750	.106	.125	51	Silver	Silver (C)	UG-1111/U
1	1.08	.750	.106	.125	51	Albaloy	Gold (C)	3816000Q511-002

- See page 208 for mounting dimensions.
- (C) in contact plating column indicates captive contact.
- See page 6 for alternate body plating information.

Resistive Termination

 Figure 1
 (Jack type)

 Figure 2
 (Plug type)

Fig.	Resistor	Dimensions			Features	Plating		Delta P/N
		A	B	C		Body	Contact	
1	50 Ω ±1%, .5 Watt	1.50	.630	—	No chain	Silver	Gold (C)	3831000A00A-000
2	50 Ω ±1%, 1 Watt	1.75	2.50	.144	Bead chain	Silver	Gold (C)	3851000A000-000

Adapters Between Series

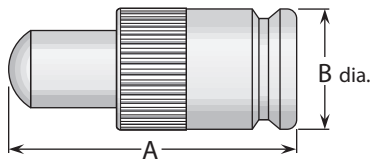
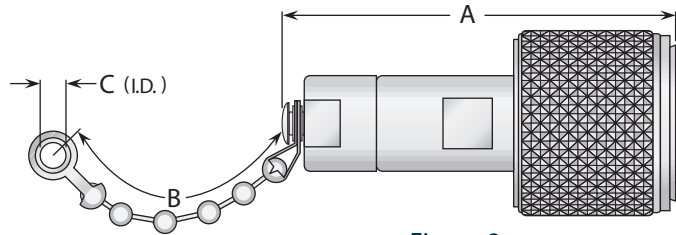
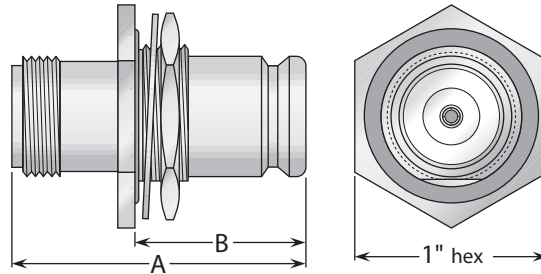
 Figure 1
 (QDS jack to N jack,
 bulkhead mounted)

Mounting figure 51; .200" max. panel

 Figure 2
 (QDS jack to N plug)

 Figure 3
 (QDS plug to N jack)

Figure	Dimensions		Plating		Delta P/N
	A	B	Body	Contact	
1	1.52	.865	Albaloy	Gold (C)	2226000Q511-001
2	1.38	.780	Albaloy	Gold (C)	2234000Q001-131
3	1.67	1.00	Silver	Silver (C)	UG-1144/U

- See page 208 for mounting dimensions.
- (C) in contact plating column indicates captive contact.
- See page 6 for alternate body plating information.

General Description

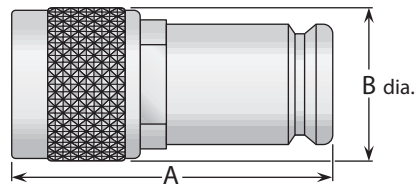
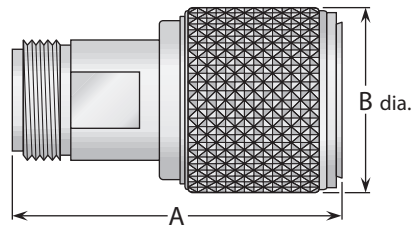
Delta QMA jacks are connectors with size and performance similar to SMA connectors, but with a snap-on interface for quick mating and unmating, and brass body construction for economy. Designed to mate with all QMA plugs, they offer good electrical performance up to 6 GHz.

The PressMount mounting configuration (see below) allows QMA receptacles to be mounted securely in a single through hole, with center-to-center spacing as little as .325 inch. New types are being added to our product line, so please call with your requirements for other QMA configurations.

QMA Jack Specifications*

Electrical:

Nominal Impedance: 50 ohms.
 Frequency Range: DC–6 GHz.
 Voltage Rating: 335 volts RMS (dependent on cable).
 Dielectric Withstanding Voltage : 1,000 volts RMS.
 Insulation Resistance: 5,000 megohms.
 VSWR: DC–3 GHz: 1.06:1 max; 3–6 GHz: 1.12:1 max.

Mechanical:

Durability: 100 mating cycles.
 Force to Engage: 26 N.
 Force to Disengage: 20 N.

Materials/Finishes:

Insulators: Teflon per ASTM D1710.
 Female Contacts: Beryllium Copper per ASTM B196.
 Contact Plating : Gold per MIL-DTL-45204.
 Gaskets: Silicone rubber per ZZ-R-765, Class II, Grade 50.
 Other Metal Parts: Brass per ASTM B16, gold plated per MIL-DTL-45204.

*These specifications are typical and may not apply to all connectors.
 Detailed specifications for individual connectors are available on request.

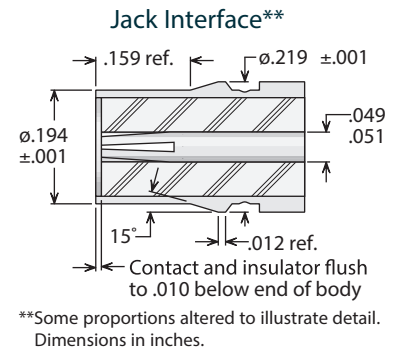

QMA Press Mount Receptacles - Post Contact

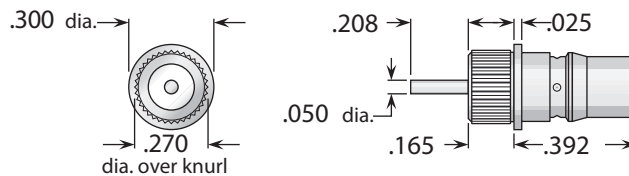

Minimum Panel Thickness	Mounting Hole Diameter	Plating		Delta P/N
		Body	Contact	
.100	.267 ± .001	Gold*	Gold (C)	4220000G911-000

Panel Jack Receptacles

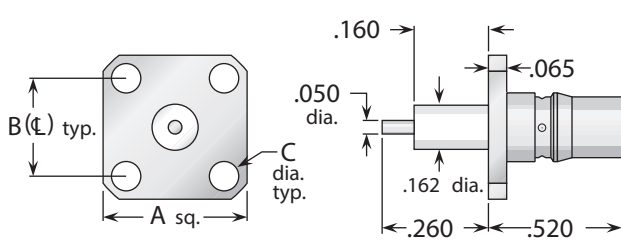

Figure 1 (Square flange)

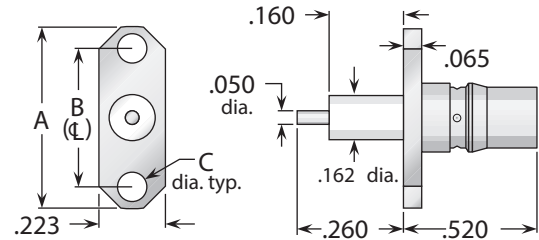

Figure 2 (Two-hole flange)

Figure	Dimensions			Mounting Figure	Plating		Delta P/N
	A	B	C		Body	Contact	
1	.500	.340	.102	05	Gold*	Gold (C)	4258000G051-009
2	.625	.481	.102	92	Gold*	Gold (C)	4258000G921-006

- * Also available with Albaloy-plated body—change G in Delta part number to Q.
- (C) in contact plating column indicates captive contact.
- See page 208 for mounting dimensions.

General Description

Delta SC series connectors are medium-size, 50Ω impedance connectors with ¹¹/₁₆-24 threaded coupling and good power handling capability, particularly those connectors noted as high-voltage types.

The interface is similar to type C, except with a threaded coupling instead of bayonet. They are best suited for use with cables in the range of .350" to .450" diameter, but are available for other cables from .200" to over 1" diameter. Our extensive line of SC receptacles includes configurations for virtually any packaging requirement, and we can supply any adapter or accessory you need to complete your system design. Adapters between SC and other series are shown starting on page 176.

As with all other Delta connector series, we welcome your specifications for special configurations.

SC Configurations

Straight Cable Plugs.....	99
Right Angle Cable Plugs.....	99
Panel Jack Receptacles (square flange)	100
Panel Plug Receptacles.....	100
Dummy Receptacles	100
Dust Caps	100
In-Series Adapters	101

SC Specifications*

Jack Interface**

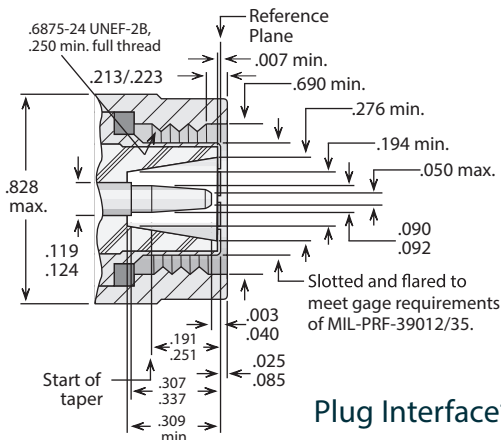
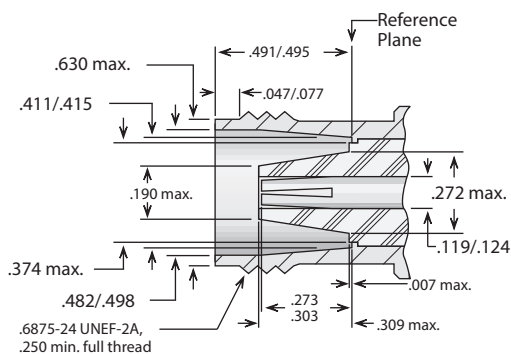

Plug Interface**

Electrical:

Nominal Impedance: 50 ohms.

Frequency Range: DC-11 GHz (standard);
DC-2 GHz (high-voltage types).

Voltage Rating: 1,000 volts RMS (standard);
4,000 volts RMS (high-voltage types).

Dielectric Withstanding

Voltage: 3,000 volts RMS (standard);
6,000 volts RMS (high-voltage types);
1,500 volts RMS (when used with RG-142).

Insulation Resistance: 5,000 megohms.

Materials/Finishes:

Insulators: Teflon per ASTM D1710.

Male Contacts: Brass per ASTM B16.

Female Contacts: Beryllium Copper per ASTM B196.

Contact Plating: Silver per ASTM B700, or
Gold per MIL-DTL-45204.

Gaskets: Silicone rubber per ZZ-R-765, Class II, Grade 50.

Other Metal Parts: Brass per ASTM B16

Plated: Silver per ASTM B700, or

Nickel per AMS-QQ-N-290.

All other specifications are in accordance with the latest issues of MIL-PRF-39012, or MIL-A-55339, or other applicable MIL specifications, and interfaces are in accordance with MIL-STD-348.

*These specifications are typical and may not apply to all connectors. Detailed specifications for individual connectors are available on request.

**Some proportions altered to illustrate detail.

Straight Plug - Military Clamp For Flexible Cable

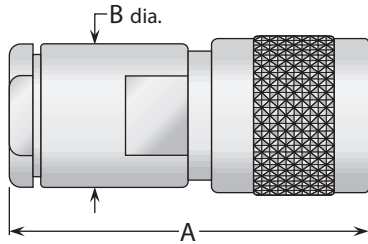

Figure 1

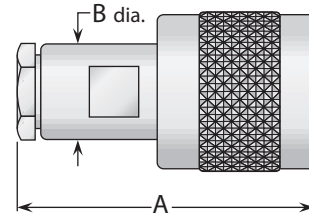

Figure 2

Cable Group	Figure	Dimensions		Plating		Delta P/N	Assembly Procedure/ Trim Code
		A	B	Body	Contact		
2, 3	1	1.47	.750	Nickel	Silver	1901004N000-001	A/01
2, 3	1	1.78	.750	Nickel	Silver	1901004N000-000*	A/21
2, 3	1	1.78	.750	Nickel	Silver (C)	1901004N001-000*	A/28
5, 6	2	1.53	.500	Nickel	Silver	1901015N000-000	A/17
5, 6	2	1.53	.500	Nickel	Silver (C)	1901015N001-000	A/02

* High voltage type.

Right Angle Plug - Military Clamp For Flexible Cable

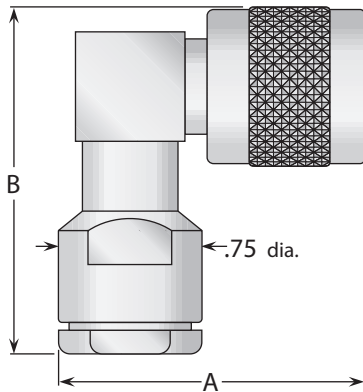

Figure 1

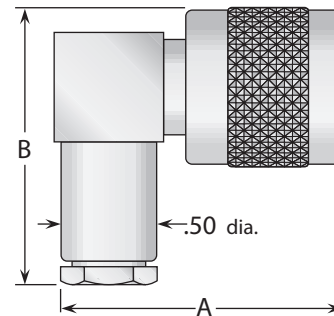

Figure 2

Cable Group	Figure	Dimensions		Plating		Delta P/N	Assembly Procedure/ Trim Code
		A	B	Body	Contact		
2, 3	1	1.56	1.94	Nickel	Silver (C)	1904004N000-000*	A/21
5, 6	2	1.45	1.75	Nickel	Silver	1905015N001-002	A/17

* High voltage type.

- See page 209 for cable groups.
- Assembly procedures start on page 210.
- (C) in contact plating column indicates captive contact.
- See page 6 for alternate body plating information.

Panel Receptacle - Solder Pot Contact

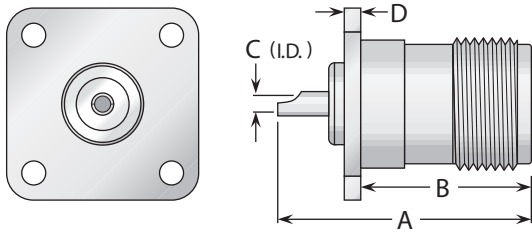

Figure 1
(Panel jack receptacle)

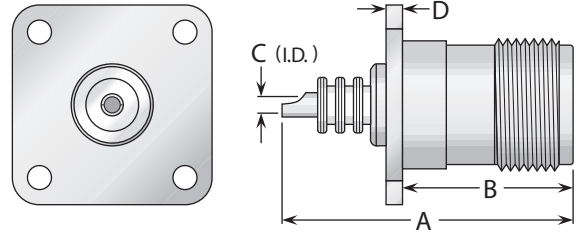

Figure 2
(Panel jack receptacle, high voltage type)

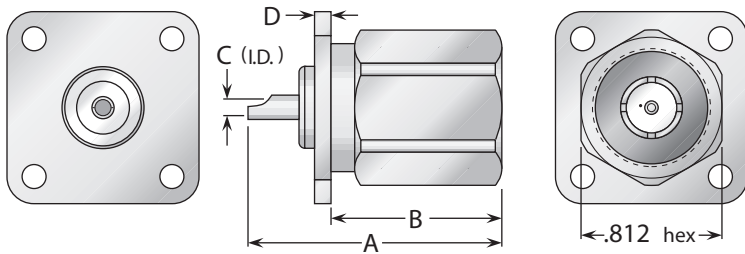

Figure 3
(Panel plug receptacle)

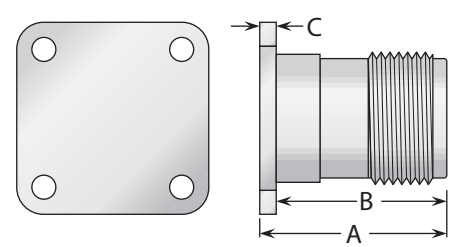

Figure 4
(Dummy receptacle)

Figure	Dimensions				Mounting Figure	Plating		Delta P/N
	A	B	C	D		Body	Contact	
1	1.25	.910	.106	.080	26	Nickel	Silver (C)	1913000N261-001
1	1.25	.910	.102	.080	33	Nickel	Gold (C)	1913000N331-002
2	1.50	.910	.106	.080	26	Nickel	Silver (C)	1913000N261-002
3	1.16	.860	.102	.080	33	Nickel	Gold (C)	1923000N331-000
4	.900	.820	.080	—	33	Nickel	—	1963000N330-000

Dust Cap

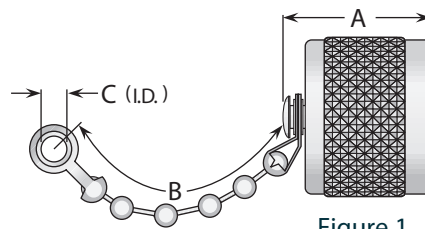
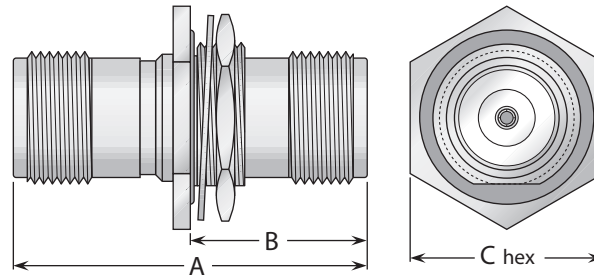

Figure 1

Figure	Dimensions			Features	Plating		Delta P/N
	A	B	C		Body	Contact	
1	.920	2.50	.144	Bead chain	Nickel	—	1932000N000-000

- See page 208 for mounting dimensions.
- (C) in contact plating column indicates captive contact.
- See page 6 for alternate body plating information.

Bulkhead Jack - Jack Adapters



(Connects two plugs, hermetically sealed)

Dimensions			Max. Panel	Mounting Figure	Plating		Delta P/N
A	B	C			Body	Contact	
1.84	1.00	1.00	.125	51	Nickel	Gold (C)	1926000N518-000

Straight & Right Angle Adapters

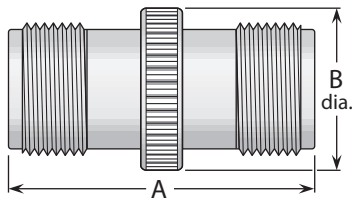

Figure 1
(Straight jack-jack;
connects two plugs)

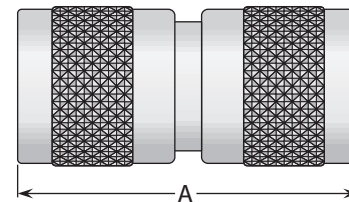

Figure 2
(Straight plug-plug;
connects two jacks)

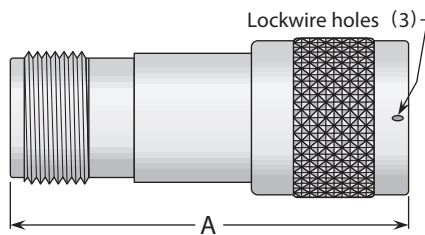

Figure 3
(Straight jack-plug;
connects one plug and one jack)

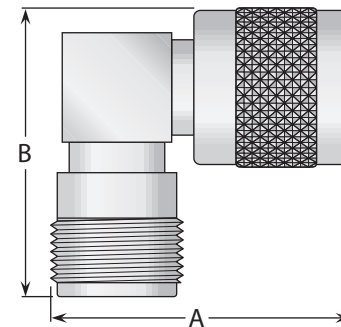

Figure 4
(Right angle jack-plug;
connects one plug and one jack)

Figure	Dimensions		Plating		Delta P/N
	A	B	Body	Contact	
1	1.64	.75	Nickel	Silver (C)	1928000N000-000
2	1.75	—	Nickel	Silver (C)	1927000N000-000
3	2.05	—	Nickel	Gold (C)	1934000N000-001
4	1.46	1.48	Nickel	Gold (C)	1935000N000-001

- (C) in contact plating column indicates captive contact.
- See page 208 for mounting dimensions.
- See page 6 for alternate body plating information.

General Description

Delta SMA connectors are subminiature, precision, 50 Ω impedance connectors with 1/4"-36 threaded coupling. They are best suited for use with high-frequency semi-rigid cables in demanding applications up to 18 GHz, or miniature flexible cables up to 12.4 GHz. Our extensive line of SMA receptacles includes configurations for virtually any packaging requirement, and we can supply any adapter or accessory you may need to complete your system design. Adapters between SMA and other series are shown starting on page 176. Many of our SMA connectors are available as MIL-PRF-39012 QPL versions. These types are listed starting on page 195.

As with our other connector series, Delta's customer-driven design results in SMA series connectors with practical and unique features that make your design and assembly process easier. Some of these include:

- One-Step cable connectors for quick, accurate assembly to semi-rigid cable.
 - PressMount receptacles (page 115) mount securely in a single round hole, saving space on your components and reducing your housing fabrication costs.
 - Panel receptacles with flange sizes to match the same hole pattern as standard BNC, TNC or N connectors, letting you drill one hole pattern and mount BNC, N, SMA, TNC, or 7/16 series connectors as needed.
 - Edge-mount P.C. board receptacles (page 114).
 - Our new E-Line brass SMA connectors provide a lower-cost alternative for commercial applications (page 123).
- Our SMA series product line is still growing, so please call if you don't see what you need.

SMA Configuration

Cable Plugs for Semi-Rigid Cable	103	Right Angle Panel Jack Receptacles	112
Cable Plugs for Flexible Cable	104	Stripline Receptacles	112
Straight Cable Jacks for Semi-Rigid Cable	105	Bulkhead Jack Receptacles	113
Bulkhead Cable Jacks for Semi-Rigid Cable	105	P.C. Board Receptacles (Through-Hole Mount)	113
Panel Cable Jacks for Semi-Rigid Cable	105	P.C. Board Receptacles (Edge Mount)	114
Straight Cable Jacks for Flexible Cable	106	PressMount Receptacles	115
Bulkhead Cable Jacks for Flexible Cable	106	Panel Plug Receptacles	116
Straight Panel Jack Receptacles	107	Dust Caps	120
Panel Jack Receptacles for Microstrip	111	In-Series Adapters	121

SMA Specifications*

Plug Interface**

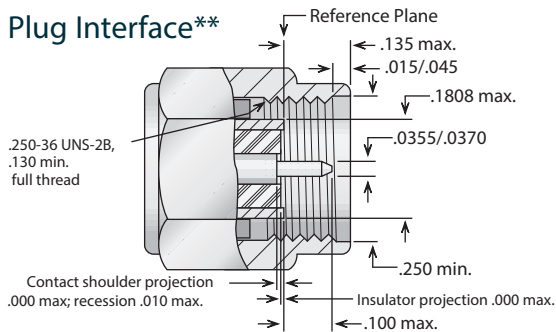

Jack Interface**

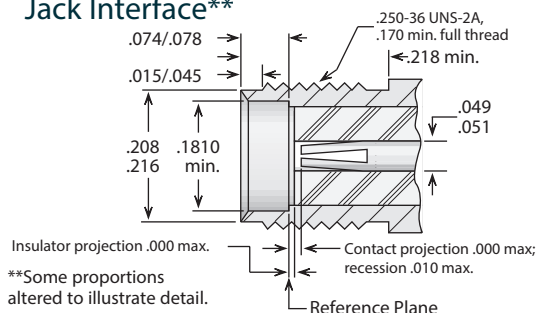

Electrical:

Nominal Impedance: 50 ohms.
 Frequency Range: DC–18 GHz (with semi-rigid cable);
 DC–12.4 GHz (with flexible cable).
 Voltage Rating: 335–500 volts RMS (dependent on cable).
 Dielectric Withstanding Voltage : 500–1500 volts RMS (dependent on cable).
 Insulation Resistance: 5,000 megohms.

Materials/Finishes:

Insulators: Teflon per ASTM D1710.
 Male Contacts: Brass per ASTM B16, or Beryllium Copper per ASTM B196.
 Female Contacts: Beryllium Copper per ASTM B196.
 Contact Plating : Gold per MIL-DTL-45204.
 Gaskets: Silicone rubber per ZZ-R-765, Class II, Grade 50.
 Other Metal Parts: Stainless steel per ASTM A582, plated gold per MIL-DTL-45204 or passivated to meet corrosion requirements of MIL-PRF-39012; or Brass per ASTM B16: plated gold per MIL-DTL-45204.

All other specifications are in accordance with the latest issues of MIL-PRF-39012, or MIL-A-55339, or other applicable MIL specifications, and interfaces are in accordance with MIL-STD-348.

*These specifications are typical and may not apply to all connectors. Detailed specifications for individual connectors are available on request.

Straight Plug - For Semi-Rigid Cable

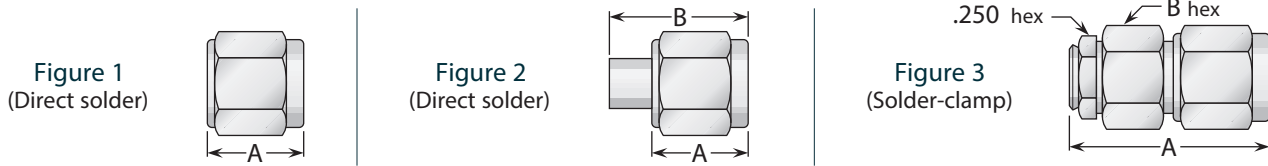

Delta One-Step Cable Attachment for Semi-Rigid Cable

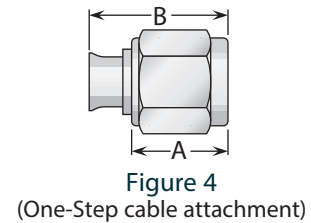
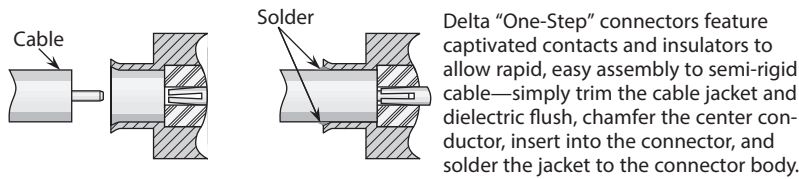

Cable Group	Figure	Dimensions		Plating		Delta P/N	Assembly Procedure/ Trim Code
		A	B	Body	Contact		
13	1	.330	—	Gold	None ⁽²⁾	1301031G003-000	G/01
13	1	.330	—	Gold/PCN ⁽¹⁾	None ⁽²⁾	1301031K003-000	G/01
13	2	.330	.445	Gold	None ⁽²⁾	1301031G003-002	G/01
13	2	.330	.445	Gold/PCN ⁽¹⁾	None ⁽²⁾	1301031K003-002	G/01
13	2	.330	.445	Gold	Gold	1301031G003-003	H/01
13	2	.330	.445	Gold/PCN ⁽¹⁾	Gold	1301031K003-012	H/01
13	3	.680	.312	Gold	Gold (C)	1301031G007-000	***
13	4	.330	.430	Gold/PCN ⁽¹⁾	Gold (C)	1301031K003-008	I/01
14	2	.330	.445	Gold	Gold	1301094G003-000	H/01
14	2	.330	.445	Gold/PCN ⁽¹⁾	Gold	1301094K003-000	H/01
14	3	.680	.312	Gold	Gold (C)	1301025G007-000	***
14	4	.330	.430	Gold/PCN ⁽¹⁾	Gold (C)	1301094K003-001	I/01

⁽¹⁾ Gold-plated body and passivated coupling nut. ⁽²⁾ Cable center conductor used as contact.

Right Angle Plug - For Semi-Rigid Cable



Cable Group	Figure	Dimensions		Plating		Delta P/N	Assembly Procedure/ Trim Code
		A	B	Body	Contact		
13	1	.680	.430	Gold	Gold (C)	1305031G003-000	J/01
13	1	.680	.430	Gold/PCN ⁽¹⁾	Gold (C)	1305031K003-000	J/01
13	2	.570	.580	Gold	Gold (C)	1305031G003-002	I/01
13	2	.570	.580	Gold/PCN ⁽¹⁾	Gold (C)	1305031K003-004	I/01
14	1	.680	.430	Gold	Gold (C)	1305025G003-000	J/01
14	1	.680	.430	Gold/PCN ⁽¹⁾	Gold (C)	1305025K003-000	J/01
14	2	.570	.580	Gold	Gold (C)	1305094G003-003	I/01
14	2	.570	.580	Gold/PCN ⁽¹⁾	Gold (C)	1305094K003-005	I/01

⁽¹⁾ Gold-plated body and passivated coupling nut.

- See page 209 for cable groups.
- Assembly procedures start on page 210.
- ***Contact factory for cable assembly instructions.
- (C) in contact plating column indicates captive contact.

Straight Plug - For Flexible Cable

Figure 1
(Crimp type, shown with supplied heat-shrink tubing)

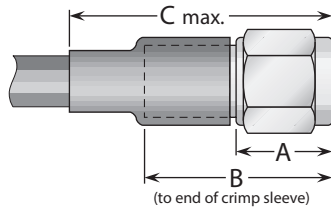
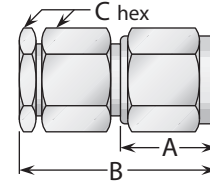

Figure 2
(Clamp type)



See page 194 for MIL-PRF-39012 QPL version.

Cable Group	Figure	Dimensions			Plating		Delta P/N	Assembly Procedure/ Trim Code
		A	B	C	Body	Contact		
5	1	.330	.700	1.187	Gold	Gold	1303017G000-000	K/02
5	1	.330	.700	1.187	Passivated	Gold	1303017K000-000	K/02
6	1	.330	.700	1.187	Gold	Gold	1303013G000-000	K/02
6	1	.330	.700	1.187	Passivated	Gold	1303013K000-002	K/02
9	1	.330	.700	1.187	Gold	Gold	1303036G000-000	K/02
9	1	.330	.700	1.187	Passivated	Gold	1303036K000-000	K/02
10	1	.330	.700	1.187	Gold	Gold	1303100G000-002	K/02
10	1	.330	.700	1.187	Passivated	Gold	1303100K000-002	K/02
5, 6	2	.330	.750	.312	Gold	Gold (C)	1301015G005-000	***
5, 6	2	.330	.750	.312	Passivated	Gold (C)	1301015K005-000	***
9	2	.330	.750	.312	Gold	Gold (C)	1301037G005-000	***
9	2	.330	.750	.312	Passivated	Gold (C)	1301037K005-000	***

Right Angle Plug - For Flexible Cable

Figure 1
(Crimp type, shown with supplied heat-shrink tubing)

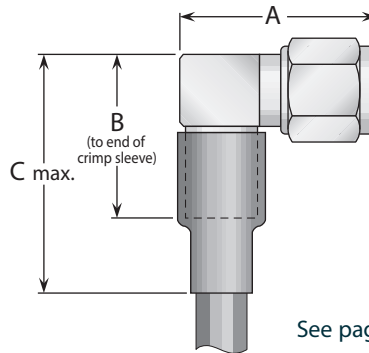

See page 195 for MIL-PRF-39012 QPL version.

Cable Group	Figure	Dimensions			Plating		Delta P/N	Assembly Procedure/ Trim Code
		A	B	C	Body	Contact		
5	1	.680	.600	1.06	Gold	Gold (C)	1307017G001-000	L/03
5	1	.680	.600	1.06	Passivated	Gold (C)	1307017K001-000	L/03
6	1	.680	.600	1.06	Gold	Gold (C)	1307013G001-000	L/03
6	1	.680	.600	1.06	Passivated	Gold (C)	1307013K001-000	L/03
9	1	.680	.600	1.06	Gold	Gold (C)	1307036G001-000	L/03
9	1	.680	.600	1.06	Passivated	Gold (C)	1307036K001-000	L/03
10	1	.680	.600	1.06	Gold	Gold (C)	1307100G001-000	L/03
10	1	.680	.600	1.06	Passivated	Gold (C)	1307100K001-000	L/03
11	1	.680	.600	1.06	Gold	Gold (C)	1307038G001-000	L/03
11	1	.680	.600	1.06	Passivated	Gold (C)	1307038K001-000	L/03

- See page 209 for cable groups.
- Assembly procedures start on page 210.
- ***Contact factory for cable assembly instructions.
- (C) in contact plating column indicates captive contact.

Straight Jack - For Semi-Rigid Cable

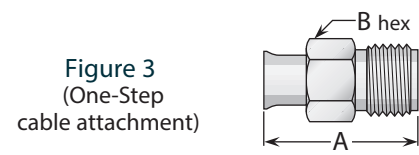
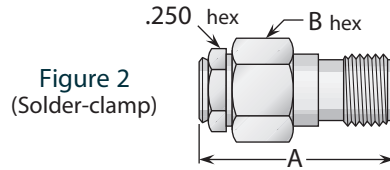
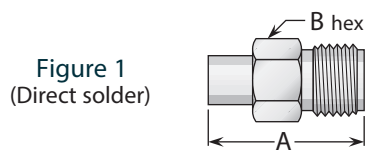

Cable Group	Figure	Dimensions			Plating		Delta P/N	Assembly Procedure/ Trim Code
		A	B	Body	Contact			
13	1	.500	.250	Gold	Gold	1308031G003-002	H/01	
13	2	.680	.312	Gold	Gold (C)	1308031G007-000	***	
13	3	.500	.250	Gold	Gold (C)	1308031G003-004	I/01	
14	1	.500	.250	Gold	Gold	1308094G003-000	H/01	
14	2	.680	.312	Gold	Gold (C)	1308025G007-000	***	
14	3	.500	.250	Gold	Gold (C)	1308094G003-001	I/01	

Panel Bulkhead Jacks - For Semi-Rigid Cable

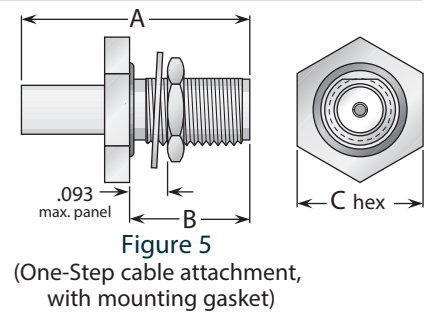
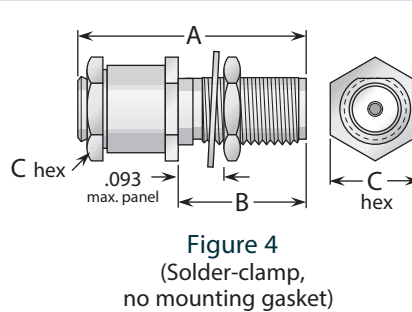
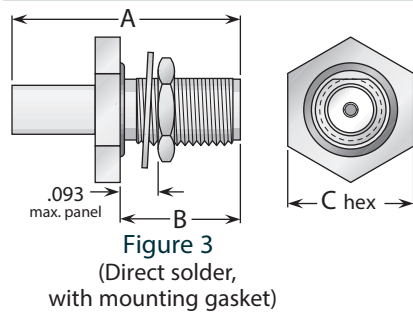
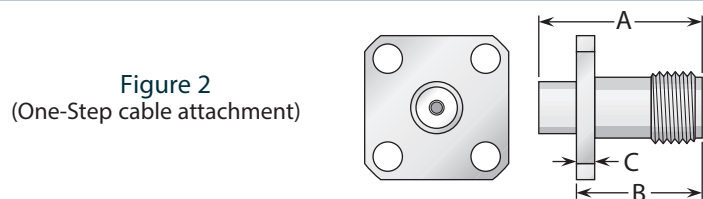
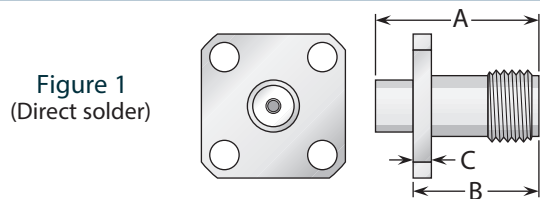

Delta One-Step Cable Attachment for Semi-Rigid Cable

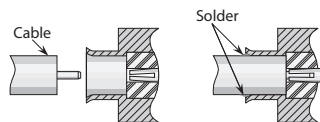

Delta "One-Step" connectors feature captivated contacts and insulators to allow rapid, easy assembly to semi-rigid cable—simply trim the cable jacket and dielectric flush, chamfer the center conductor, insert into the connector, and solder the jacket to the connector body.

Cable Group	Fig.	Dimensions			Mounting Figure	Plating		Delta P/N	Assembly Procedure/ Trim Code
		A	B	C		Body	Contact		
13	1	.560	.375	.065	05	Gold	Gold	1311031G053-000	H/01
13	2	.500	.375	.065	05	Gold	Gold (C)	1311031G053-003	I/01
13	3	.750	.415	.437	67	Gold	Gold	1317031G673-000	H/02
13	4	.750	.440	.312	67	Gold	Gold (C)	1317031G677-000	***
13	5	.700	.415	.437	67	Gold	Gold (C)	1317031G673-003	I/01
14	1	.500	.375	.065	05	Gold	Gold	1311025G053-000	H/01
14	2	.500	.375	.065	05	Gold	Gold (C)	1311025G053-001	I/01
14	3	.750	.415	.437	67	Gold	Gold	1317025G673-000	H/02
14	4	.750	.440	.312	67	Gold	Gold (C)	1317025G677-000	***
14	5	.750	.415	.437	67	Gold	Gold (C)	1317025G673-001	I/01

- See page 209 for cable groups.
- Assembly procedures start on page 210.
- ***Contact factory for cable assembly instructions.
- See page 208 for mounting dimensions.
- (C) in contact plating column indicates captive contact.

Straight Jack - For Flexible Cable

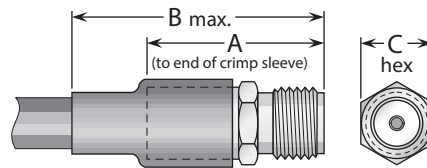

Figure 1
(Crimp type, shown with supplied heat-shrink tubing)

See page 195 for MIL-PRF-39012 QPL version.

Cable Group	Figure	Dimensions			Plating		Delta P/N	Assembly Procedure/ Trim Code
		A	B	C	Body	Contact		
5	1	.800	1.125	.250	Gold	Gold	1308017G000-000	K/03
5	1	.800	1.125	.250	Passivated	Gold	1308017K000-000	K/03
6	1	.800	1.125	.250	Gold	Gold	1308013G000-000	K/03
6	1	.800	1.125	.250	Passivated	Gold	1308013K000-000	K/03
9	1	.800	1.125	.250	Gold	Gold	1308037G000-000	K/03
9	1	.800	1.125	.250	Passivated	Gold	1308037K000-000	K/03

Bulkhead Jack - For Flexible Cable

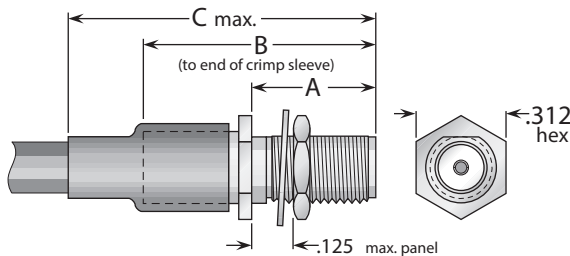

Figure 1
(Crimp type, shown with supplied heat-shrink tubing)

See page 196 for MIL-PRF-39012 QPL version.

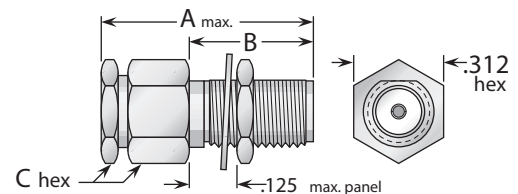

Figure 2
(Clamp type)

Cable Group	Fig.	Dimensions			Mounting Figure	Plating		Delta P/N	Assembly Procedure/ Trim Code
		A	B	C		Body	Contact		
5	1	.450	.940	1.25	67	Gold	Gold	1319017G670-000	K/04
5	1	.450	.940	1.25	67	Passivated	Gold	1319017K670-000	K/04
6	1	.450	.940	1.25	67	Gold	Gold	1319013G670-000	K/04
6	1	.450	.940	1.25	67	Passivated	Gold	1319013K670-000	K/04
9	1	.450	.940	1.25	67	Gold	Gold	1319037G670-000	K/04
9	1	.450	.940	1.25	67	Passivated	Gold	1319037K670-000	K/04
10	1	.450	.940	1.25	67	Gold	Gold	1319100G670-000	K/04
10	1	.450	.940	1.25	67	Passivated	Gold	1319100K670-000	K/04
5, 6	2	.850	.450	.312	67	Gold	Gold (C)	1316015G675-000	***
5, 6	2	.850	.450	.312	67	Passivated	Gold (C)	1316015K675-000	***
9	2	.850	.450	.312	67	Gold	Gold (C)	1316037G675-000	***
9	2	.850	.450	.312	67	Passivated	Gold (C)	1316037K675-000	***

- See page 209 for cable groups.
- Assembly procedures start on page 210.
- ***Contact factory for cable assembly instructions.
- See page 208 for mounting dimensions.
- (C) in contact plating column indicates captive contact.

Panel Jack Receptacle - Solder Pot Contact

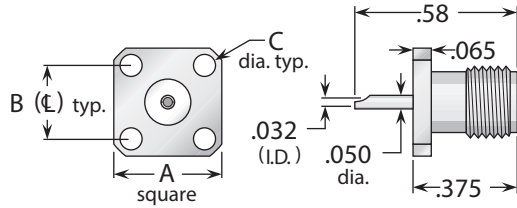

Figure 1
(3/8" square flange)

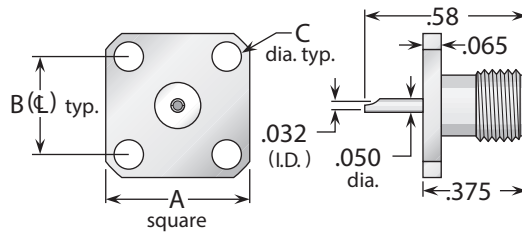

Figure 2
(1/2" square flange, SMA standard flange size)

See page 197 for MIL-PRF-39012 QPL version.

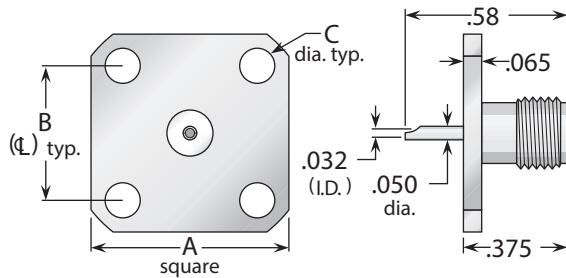

Figure 3
(11/16" square flange, interchangeable with BNC and TNC standard flange size)

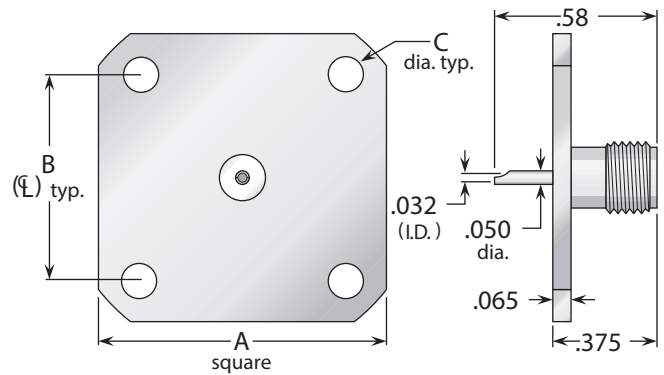

Figure 4
(1" square flange, interchangeable with type N standard flange size)

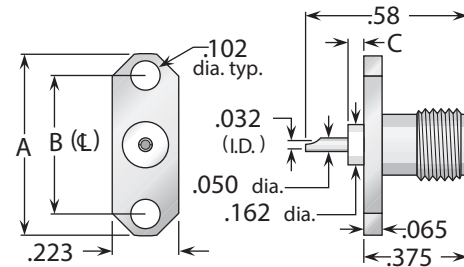

Figure 5
(2-hole flange)

See page 197 for MIL-PRF-39012 QPL version.

Figure	Dimensions			Mounting Figure	Plating		Delta P/N
	A	B	C		Body	Contact	
1	.375	.250	.067	91	Gold	Gold (C)	1313000G911-000
1	.375	.250	.067	91	Passivated	Gold (C)	1313000K911-000
2	.500	.340	.102	05	Gold	Gold (C)	1313000G051-000
2	.500	.340	.102	05	Passivated	Gold (C)	1313000K051-002
3	.687	.500	.125	09	Gold	Gold (C)	1313000G091-000
3	.687	.500	.125	09	Passivated	Gold (C)	1313000K091-000
4	1.00	.718	.125	33	Gold	Gold (C)	1313000G331-000
4	1.00	.718	.125	33	Passivated	Gold (C)	1313000K331-000
5	.625	.481	.025	92	Gold	Gold (C)	1313000G921-000
5	.625	.481	.025	92	Passivated	Gold (C)	1313000K921-000
5	.625	.481	.000	92	Gold	Gold (C)	1313000G921-002
5	.625	.481	.000	92	Passivated	Gold (C)	1313000K921-002

- See page 208 for mounting dimensions.
- (C) in contact plating column indicates captive contact (epoxy captivated).
- All items available with other flange, contact, and insulator configurations.

Panel Jack Receptacle - Tab Contact

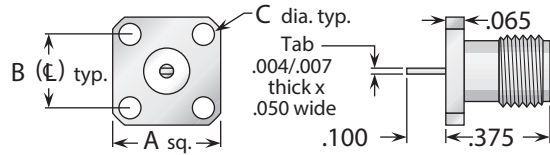

Figure 1
(3/8" square flange)

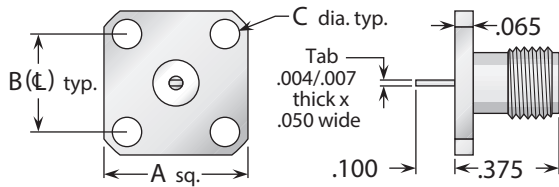

Figure 2
(1/2" square flange, SMA standard flange size)

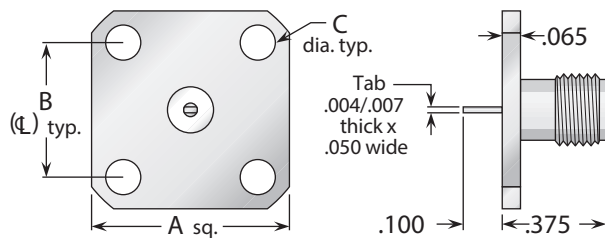

Figure 3
(11/16" square flange, interchangeable with BNC and TNC standard flange size)

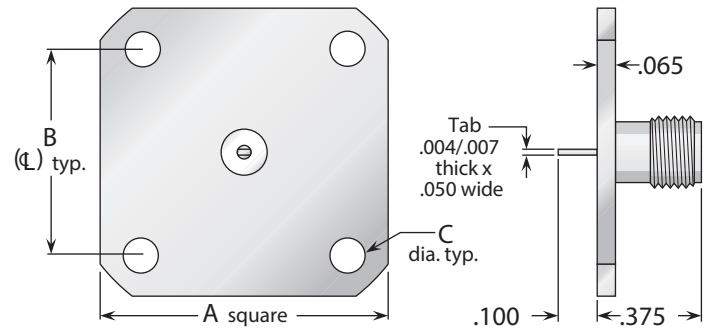

Figure 4
(1" square flange, interchangeable with type N standard flange size)

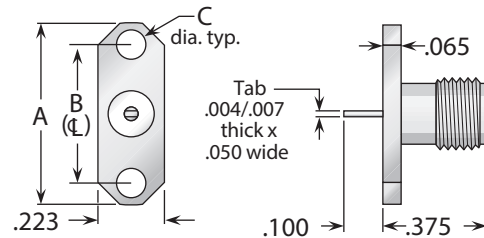

Figure 5
(2-hole flange)

Figure	Dimensions			Mounting Figure	Plating		Delta P/N
	A	B	C		Body	Contact	
1	.375	.250	.067	91	Gold	Gold	1358000G910-002
1	.375	.250	.067	91	Passivated	Gold	1358000K910-002
1	.375	.250	.067	91	Gold	Gold (C)	1358000G911-059
1	.375	.250	.067	91	Passivated	Gold (C)	1358000K911-059
2	.500	.340	.102	05	Gold	Gold	1358000G050-005
2	.500	.340	.102	05	Passivated	Gold	1358000K050-005
2	.500	.340	.102	05	Gold	Gold (C)	1358000G051-003
2	.500	.340	.102	05	Passivated	Gold (C)	1358000K051-003
3	.687	.500	.125	09	Gold	Gold	1358000G090-001
3	.687	.500	.125	09	Passivated	Gold	1358000K090-001
3	.687	.500	.125	09	Gold	Gold (C)	1358000G091-008
3	.687	.500	.125	09	Passivated	Gold (C)	1358000K091-008
4	1.00	.718	.125	33	Gold	Gold	1358000G330-001
4	1.00	.718	.125	33	Passivated	Gold	1358000K330-001
4	1.00	.718	.125	33	Gold	Gold (C)	1358000G331-002
4	1.00	.718	.125	33	Passivated	Gold (C)	1358000K331-002
5	.625	.481	.102	92	Gold	Gold	1358000G920-003
5	.625	.481	.102	92	Passivated	Gold	1358000K920-003
5	.625	.481	.102	92	Gold	Gold (C)	1358000G921-063
5	.625	.481	.102	92	Passivated	Gold (C)	1358000K921-063

- See page 208 for mounting dimensions.
- (C) in contact plating column indicates captive contact (epoxy captivated).
- All items available with other flange, contact, and insulator configurations.

Panel Jack Receptacle - Slotted Contact

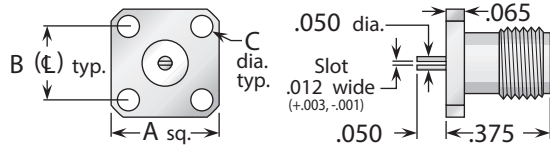

Figure 1
(3/8" square flange)

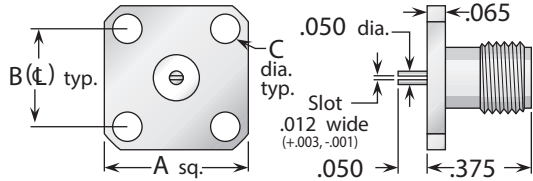

Figure 2
(1/2" square flange, SMA standard flange size)

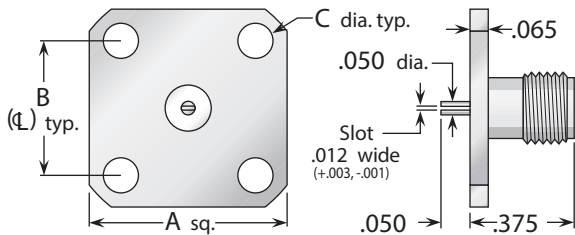

Figure 3
(11/16" square flange, interchangeable with BNC and TNC standard flange size)

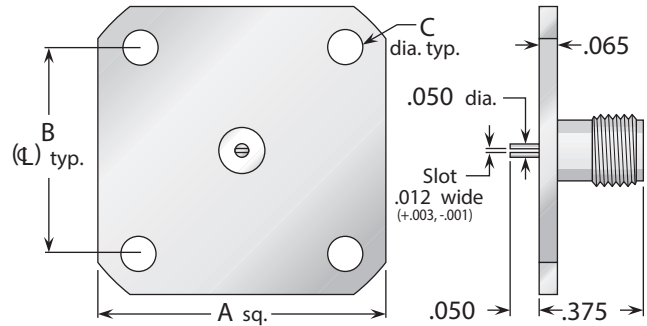

Figure 4
(1" square flange, interchangeable with type N standard flange size)

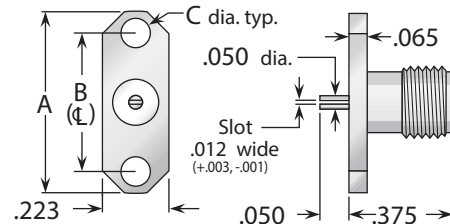

Figure 5
(2-hole flange)

Other Standard Slot Widths

Our other standard slot widths for these connectors (.018" and .036") are readily available—call for part numbers.

Figure	Dimensions			Mounting Figure	Plating		Delta P/N
	A	B	C		Body	Contact	
1	.375	.250	.067	91	Gold	Gold	1343000G910-003
1	.375	.250	.067	91	Passivated	Gold	1343000K910-003
1	.375	.250	.067	91	Gold	Gold (C)	1343000G911-006
1	.375	.250	.067	91	Passivated	Gold (C)	1343000K911-006
2	.500	.340	.102	05	Gold	Gold	1343000G050-006
2	.500	.340	.102	05	Passivated	Gold	1343000K050-006
2	.500	.340	.102	05	Gold	Gold (C)	1343000G051-021
2	.500	.340	.102	05	Passivated	Gold (C)	1343000K051-021
3	.687	.500	.125	09	Gold	Gold	1343000G090-001
3	.687	.500	.125	09	Passivated	Gold	1343000K090-001
3	.687	.500	.125	09	Gold	Gold (C)	1343000G091-006
3	.687	.500	.125	09	Passivated	Gold (C)	1343000K091-006
4	1.00	.718	.125	33	Gold	Gold	1343000G330-006
4	1.00	.718	.125	33	Passivated	Gold	1343000K330-006
4	1.00	.718	.125	33	Gold	Gold (C)	1343000G331-011
4	1.00	.718	.125	33	Passivated	Gold (C)	1343000K331-011
5	.625	.481	.102	92	Gold	Gold	1343000G920-004
5	.625	.481	.102	92	Passivated	Gold	1343000K920-004
5	.625	.481	.102	92	Gold	Gold (C)	1343000G921-006
5	.625	.481	.102	92	Passivated	Gold (C)	1343000K921-006

- See page 208 for mounting dimensions.
- (C) in contact plating column indicates captive contact (epoxy captivated).
- All items available with other flange, contact, and insulator configurations.

Panel Jack Receptacle - Post Contact

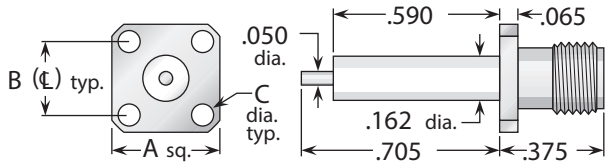

Figure 1
(3/8" square flange)

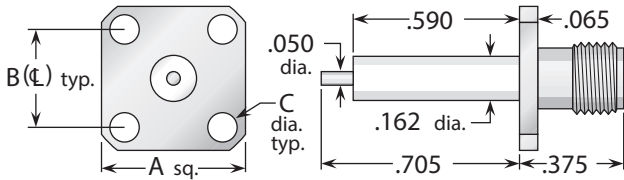

Figure 2
(1/2" square flange, SMA standard flange size)

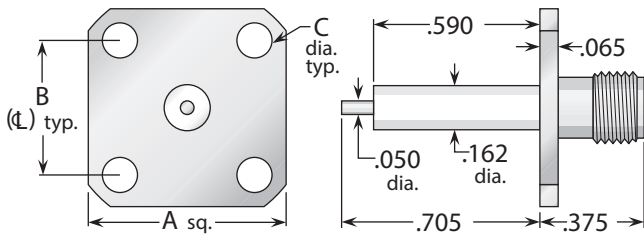

Figure 3
(11/16" square flange, interchangeable with BNC and TNC standard flange size)

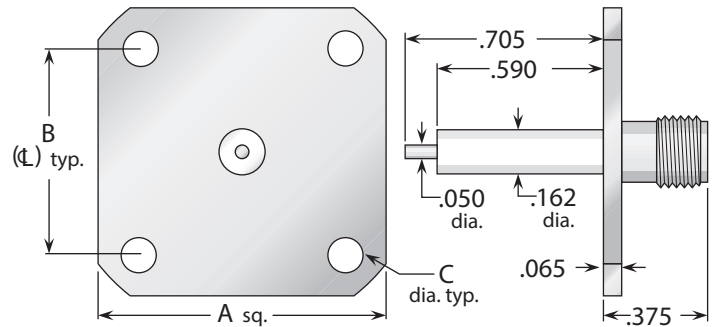

Figure 4
(1" square flange, interchangeable with type N standard flange size)

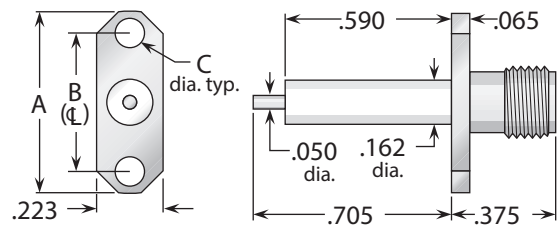

Figure 5
(2-hole flange)

Figure	Dimensions			Mounting Figure	Plating		Delta P/N
	A	B	C		Body	Contact	
1	.375	.250	.067	91	Gold	Gold	1358000G910-003
1	.375	.250	.067	91	Passivated	Gold	1358000K910-003
1	.375	.250	.067	91	Gold	Gold (C)	1358000G911-061
1	.375	.250	.067	91	Passivated	Gold (C)	1358000K911-061
2	.500	.340	.102	05	Gold	Gold	1358000G050-000
2	.500	.340	.102	05	Passivated	Gold	1358000K050-004
2	.500	.340	.102	05	Gold	Gold (C)	1358000G051-000
2	.500	.340	.102	05	Passivated	Gold (C)	1358000K051-000
3	.687	.500	.125	09	Gold	Gold	1358000G090-000
3	.687	.500	.125	09	Passivated	Gold	1358000K090-000
3	.687	.500	.125	09	Gold	Gold (C)	1358000G091-014
3	.687	.500	.125	09	Passivated	Gold (C)	1358000K091-014
4	1.00	.718	.125	33	Gold	Gold	1358000G330-000
4	1.00	.718	.125	33	Passivated	Gold	1358000K330-000
4	1.00	.718	.125	33	Gold	Gold (C)	1358000G331-003
4	1.00	.718	.125	33	Passivated	Gold (C)	1358000K331-003
5	.625	.481	.102	92	Gold	Gold	1358000G920-000
5	.625	.481	.102	92	Passivated	Gold	1358000K920-000
5	.625	.481	.102	92	Gold	Gold (C)	1358000G921-010
5	.625	.481	.102	92	Passivated	Gold (C)	1358000K921-010

- See page 208 for mounting dimensions.
- (C) in contact plating column indicates captive contact (epoxy captivated).
- All items available with other flange, contact, and insulator configurations.

Panel Jack Receptacle - Post Contact (For Microstrip)

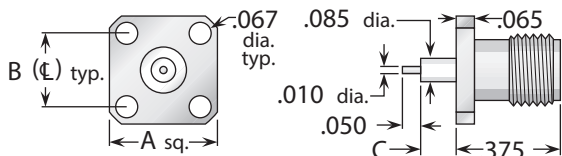

Figure 1
(3/8" square flange)

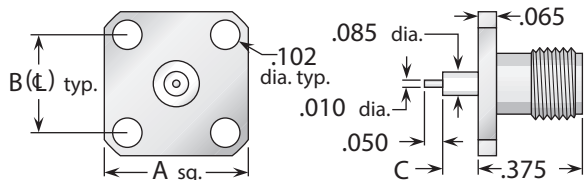

Figure 2
(1/2" square flange, SMA standard flange size)

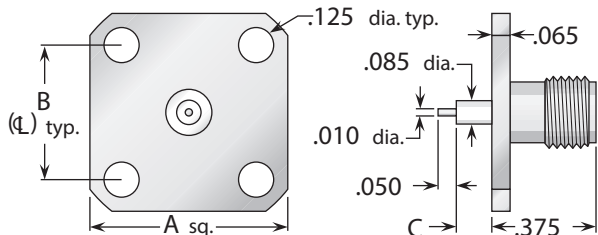

Figure 3
(11/16" square flange, interchangeable with BNC and TNC standard flange size)

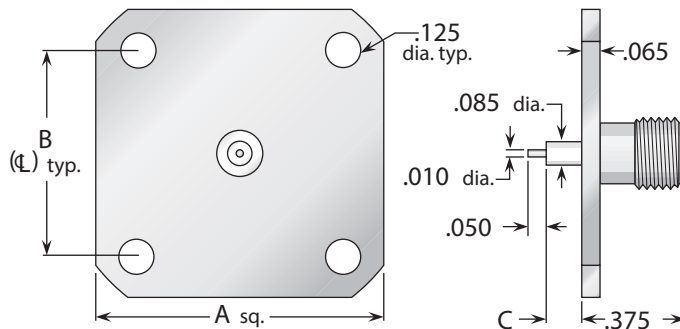

Figure 4
(1" square flange, interchangeable with type N standard flange size)

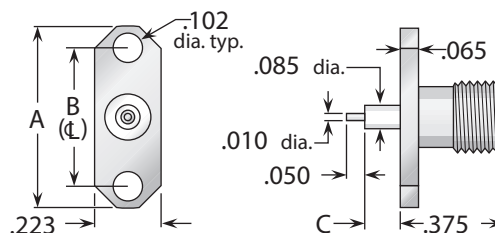

Figure 5
(2-hole flange)

Figure	Dimensions			Mounting Figure	Plating		Delta P/N
	A	B	C		Body	Contact	
1	.375	.250	.057	91	Gold	Gold (C)	1358000G911-014
1	.375	.250	.057	91	Passivated	Gold (C)	1358000K911-014
1	.375	.250	.125	91	Gold	Gold (C)	1358000G911-085
1	.375	.250	.125	91	Passivated	Gold (C)	1358000K911-085
2	.500	.340	.057	05	Gold	Gold (C)	1358000G051-019
2	.500	.340	.057	05	Passivated	Gold (C)	1358000K051-019
2	.500	.340	.125	05	Gold	Gold (C)	1358000G051-128
2	.500	.340	.125	05	Passivated	Gold (C)	1358000K051-128
3	.687	.500	.057	09	Gold	Gold (C)	1358000G091-015
3	.687	.500	.057	09	Passivated	Gold (C)	1358000K091-015
3	.687	.500	.125	09	Gold	Gold (C)	1358000G091-016
3	.687	.500	.125	09	Passivated	Gold (C)	1358000K091-016
4	1.00	.718	.057	33	Gold	Gold (C)	1358000G331-004
4	1.00	.718	.057	33	Passivated	Gold (C)	1358000K331-004
4	1.00	.718	.125	33	Gold	Gold (C)	1358000G331-005
4	1.00	.718	.125	33	Passivated	Gold (C)	1358000K331-005
5	.625	.481	.057	92	Gold	Gold (C)	1358000G051-035
5	.625	.481	.057	92	Passivated	Gold (C)	1358000K051-035
5	.625	.481	.125	92	Gold	Gold (C)	1358000G051-034
5	.625	.481	.125	92	Passivated	Gold (C)	1358000K051-034

- See page 208 for mounting dimensions.
- (C) in contact plating column indicates captive contact (epoxy captivated).
- All items available with other flange, contact, and insulator configurations.

Right Angle Panel Jack Receptacle

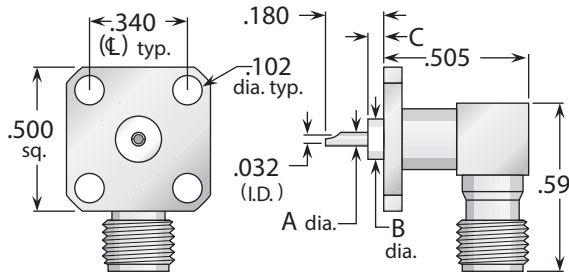

Figure 1 (Solder pot contact)

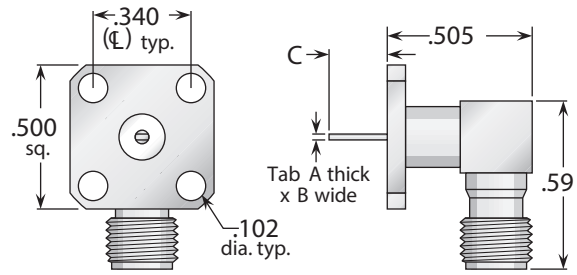

Figure 2 (Tab contact)

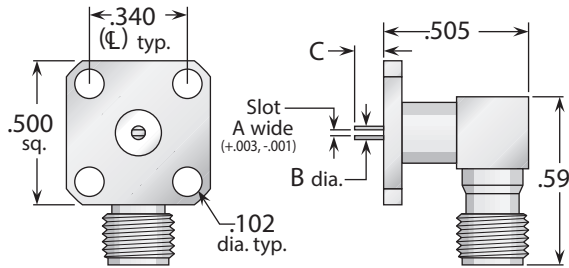

Figure 3 (Slotted contact)

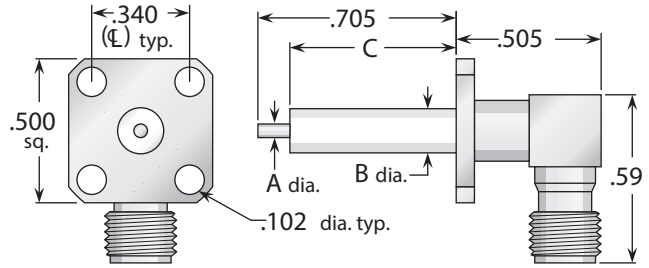

Figure 4 (Post contact)

Figure	Dimensions			Mounting Figure	Plating		Delta P/N
	A	B	C		Body	Contact	
1	.050	.162	.062	05	Gold	Gold (C)	1315000G050-000
1	.050	.162	.062	05	Passivated	Gold (C)	1315000K050-000
2	.004/.007	.050	.100	05	Gold	Gold (C)	1364000G051-015
2	.004/.007	.050	.100	05	Passivated	Gold (C)	1364000K051-015
3	.012	.050	.102	05	Gold	Gold (C)	1366000G051-017
3	.012	.050	.050	05	Passivated	Gold (C)	1366000K051-017
3	.018	.050	.050	05	Gold	Gold (C)	1366000G051-018
3	.018	.050	.050	05	Passivated	Gold (C)	1366000K051-018
3	.036	.050	.050	05	Gold	Gold (C)	1366000G051-019
3	.036	.050	.050	05	Passivated	Gold (C)	1366000K051-019
4	.050	.162	.590	05	Gold	Gold (C)	1364000G051-016
4	.050	.162	.590	05	Passivated	Gold (C)	1364000K051-016

Stripline Receptacle

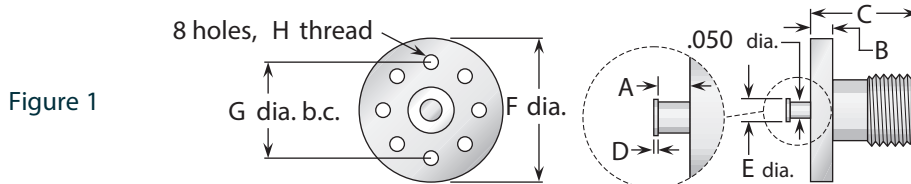

Figure	Dimensions								Plating		Delta P/N
	A	B	C	D	E	F	G	H	Body	Contact	
1	.031	.085	.375	.010	.072	.562	.438	#2-56	Gold	Gold	1357000G000-012
1	.031	.085	.375	.010	.072	.562	.438	#2-56	Passivated	Gold	1357000K000-012
1	.063	.085	.375	.010	.072	.562	.438	#2-56	Gold	Gold	1357000G000-002
1	.063	.085	.375	.010	.072	.562	.438	#2-56	Passivated	Gold	1357000K000-002
1	.125	.085	.375	.010	.072	.562	.438	#2-56	Gold	Gold	1357000G000-006
1	.125	.085	.375	.010	.072	.562	.438	#2-56	Passivated	Gold	1357000K000-006

- See page 208 for mounting dimensions.
- (C) in contact plating column indicates captive contact.
- All items available with other flange, contact, and insulator configurations.

Bulkhead Jack Receptacles

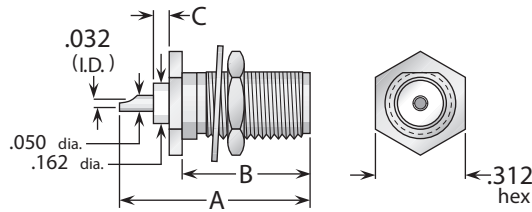

Figure 1

(Rear mount, solder pot contact, no mounting gasket)

See page 197 for MIL-PRF-39012 QPL version.

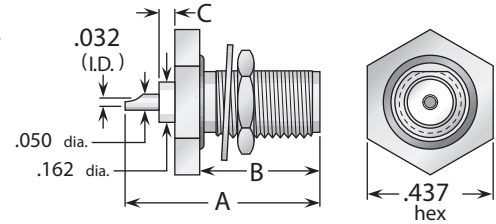

Figure 2

(Rear mount, solder pot contact, with mounting gasket)

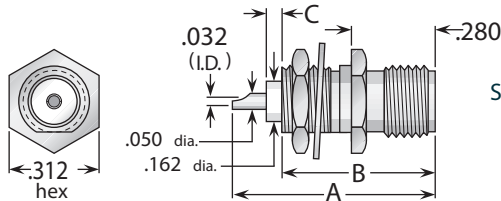

Figure 3

(Front mount, solder pot contact, no mounting gasket)

See page 197 for MIL-PRF-39012 QPL version.

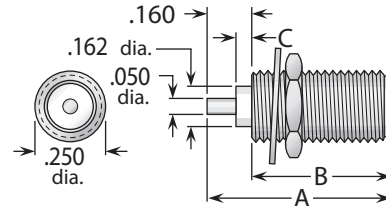

Figure 4

(Round body, post contact)

Figure	Dimensions			Max. Panel	Mounting Figure	Plating		Delta P/N
	A	B	C			Body	Contact	
1	.670	.450	.000	.125	67	Gold	Gold (C)	1320000G671-000
1	.670	.450	.000	.125	67	Passivated	Gold (C)	1320000K671-000
1	.670	.450	.062	.125	67	Gold	Gold (C)	1320000G821-002
1	.670	.450	.062	.125	67	Passivated	Gold (C)	1320000K821-000
2	.670	.415	.062	.093	67	Gold	Gold (C)	1320000G821-000
2	.670	.415	.062	.093	67	Passivated	Gold (C)	1320000K821-011
3	.670	.500	.062	.125	67	Gold	Gold (C)	1320000G671-005
3	.670	.500	.062	.125	67	Passivated	Gold (C)	1320000K671-005
4	.660	.500	.076	.125	82	Gold	Gold	1321000G820-003
4	.660	.500	.076	.125	82	Passivated	Gold	1321000K820-003
4	.660	.500	.076	.125	82	Gold	Gold (C)	1321000G821-000
4	.660	.500	.076	.125	82	Passivated	Gold (C)	1321000K821-014
4	.660	.500	.000	.125	82	Gold	Gold (C)	1321000G821-065
4	.660	.500	.000	.125	82	Passivated	Gold (C)	1321000K821-065

Printed-Circuit Board Receptacles - Through-Hole Mount

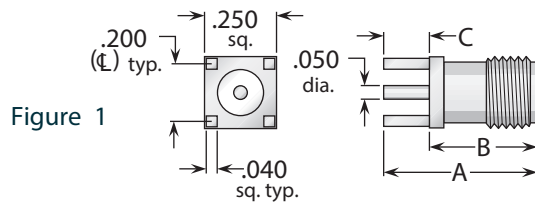

Figure 1

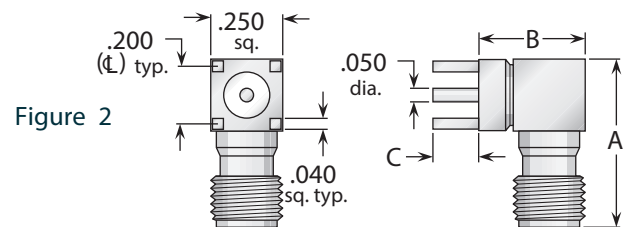

Figure 2

Figure	Dimensions			Max. Board	Mounting Figure	Plating		Delta P/N
	A	B	C			Body	Contact	
1	.530	.375	.155	.125	PCB05	Gold	Gold (C)	1367000G911-000
2	.583	.375	.155	.125	PCB05	Gold	Gold (C)	1369000G000-000

See page 208 for mounting dimensions. • (C) in contact plating column indicates captive contact (epoxy captivated).
All items available with other contact and insulator configurations.

Delta Edge Mount Receptacles

These connectors eliminate the need for drilling P.C. boards for mounting. Edge mounting provides design versatility, particularly in daughterboard configurations.

In addition, styles with bulkhead mounting allow P.C. boards to be attached directly to component housings or panels, eliminating the expense of adapters, cable assemblies, and/or additional board mounting hardware. Bulkhead mounted types are available with mounting gaskets as an option (see picture).

Delta SMA edge mount receptacles feature gold-plated brass bodies for low cost, with gold-plated beryllium copper center contacts. Insulators and contacts are mechanically captivated to meet MIL-PRF-39012 requirements. All are available with stainless-steel bodies.

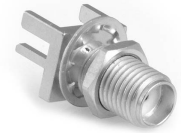

Bulkhead jack with mounting gasket

Edge Mount P.C. Board Receptacles - Bulkhead Jack

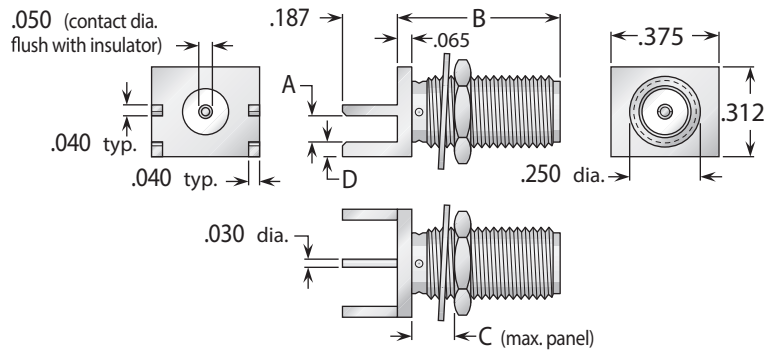

Board Thickness	Dimensions				Plating		Delta P/N
	A	B	C	D	Body	Contact	
.042	.048	.500	.125	.093	Gold	Gold (C)	1367000G91P-021
.047	.053	.500	.125	.088	Gold	Gold (C)	1367000G91P-022
.062	.068	.500	.125	.073	Gold	Gold (C)	1367000G91P-006
.062	.068	.820	.425	.073	Gold	Gold (C)	1367000G91P-023

Edge Mount P.C. Board Receptacles - Straight Jack

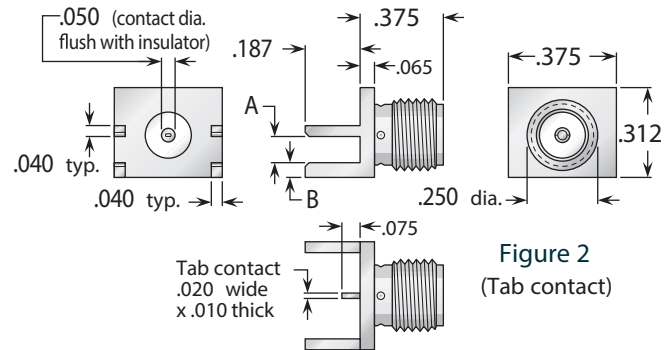
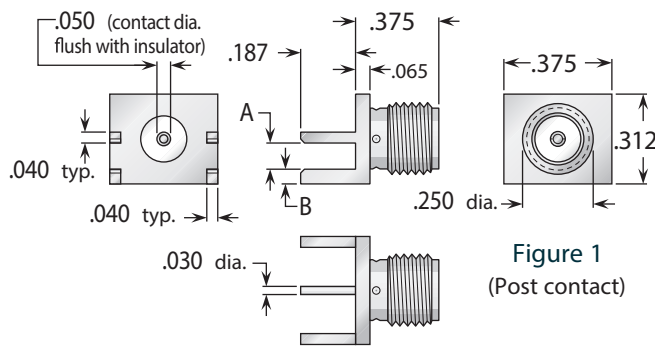
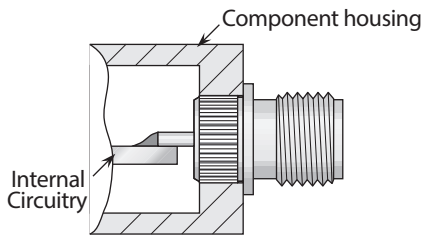

Figure	Board Thickness	Dimensions		Plating		Delta P/N
		A	B	Body	Contact	
1	.042	.048	.093	Gold	Gold (C)	1367000G91P-026
1	.047	.053	.088	Gold	Gold (C)	1367000G91P-027
1	.062	.068	.073	Gold	Gold (C)	1367000G91P-000
2	.042	.048	.103	Gold	Gold (C)	1367000G91P-024
2	.047	.053	.098	Gold	Gold (C)	1367000G91P-025
2	.062	.068	.083	Gold	Gold (C)	1367000G91P-020

• (C) in contact plating column indicates captive contact (mechanical captivation). • See page 114 for plug types.

Press Mount Receptacles



Delta PressMount Receptacles

These connectors eliminate the need for complicated mounting hole patterns and mounting hardware.

They are simply pressed into a single through hole, and the precisely-engineered knurled mounting section provides retention strength far greater than normal mating and unmating forces. An integral shoulder provides a positive stop when mounting.

PressMounts are available for a wide variety of Delta connector series, and can be used in packages as small as the outer diameter of the connector body.

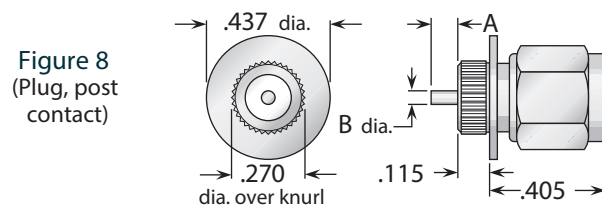
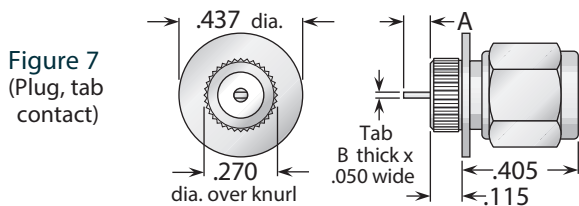
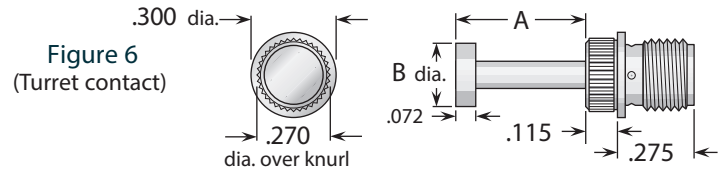
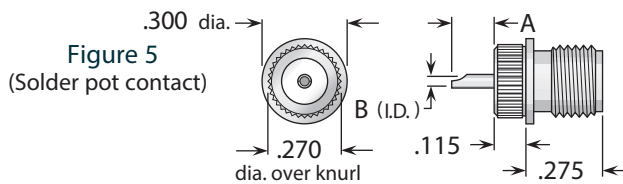
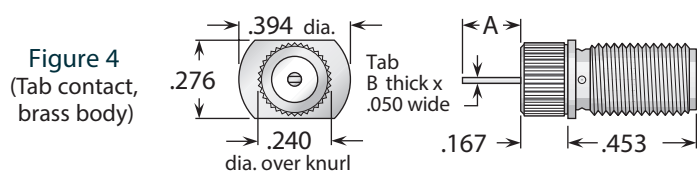
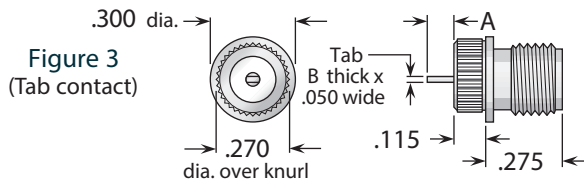
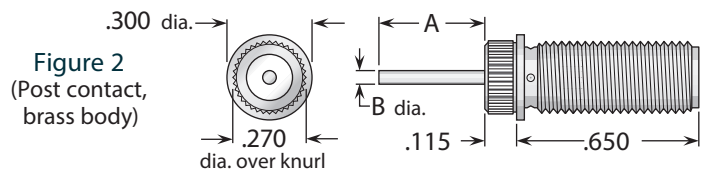
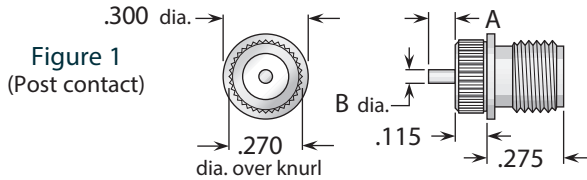

Figure	Dimensions		Min. Panel	Mounting Hole	Plating		Delta P/N
	A	B			Body	Contact	
1	.062	.050	.100	.267 ±.001 dia.	Passivated	Gold (C)	1320000K911-002
2	.390	.050	.100	.267 ±.001 dia.	Gold	Gold (C)	1320000G911-076
3	.100	.005/.008	.100	.267 ±.001 dia.	Passivated	Gold (C)	1320000K911-003
4	.120	.005/.008	.100	.237 ±.001 dia.	Gold	Gold (C)	1320000G911-084
5	.200	.032	.100	.267 ±.001 dia.	Passivated	Gold (C)	1320000K911-004
6	.465	.250	.100	.267 ±.001 dia.	Gold	Gold (C)	1320000G911-085
6	.425	.250	.100	.267 ±.001 dia.	Gold	Gold (C)	1320000G911-078
7	.100	.005/.008	.100	.267 ±.001 dia.	Passivated	Gold (C)	1324000K911-003
8	.062	.050	.100	.267 ±.001 dia.	Passivated	Gold (C)	1324000K911-002

(C) in contact plating column indicates captive contact (mechanical captivation).

Edge Mount P.C. Board Receptacles - Straight Plugs

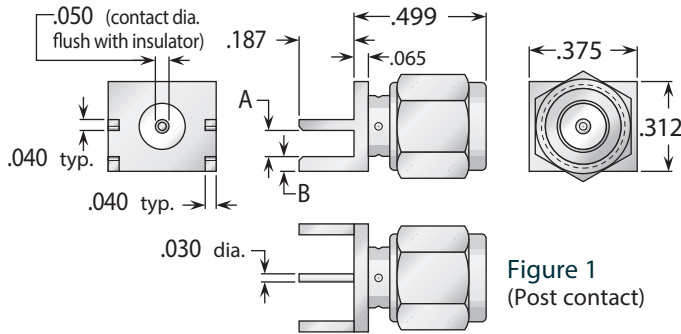

Figure 1
(Post contact)

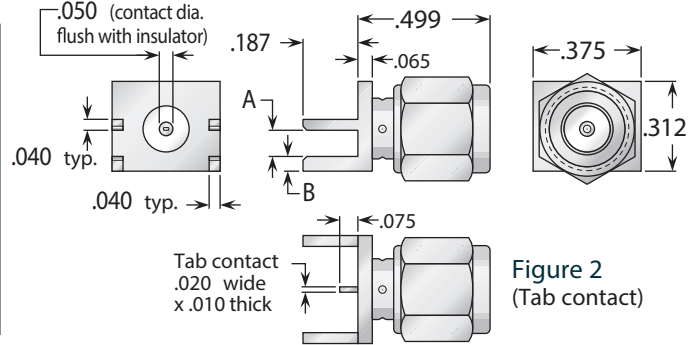

Figure 2
(Tab contact)

Figure	Board Thickness	Dimensions		Plating		Delta P/N
		A	B	Body	Contact	
1	.042	.048	.093	Gold	Gold (C)	1368000G91P-004
1	.047	.053	.088	Gold	Gold (C)	1368000G91P-005
1	.062	.068	.073	Gold	Gold (C)	1368000G91P-006
2	.042	.048	.103	Gold	Gold (C)	1368000G91P-001
2	.047	.053	.098	Gold	Gold (C)	1368000G91P-002
2	.062	.068	.083	Gold	Gold (C)	1368000G91P-003

Panel Plug Receptacles - Solder Pot Contact

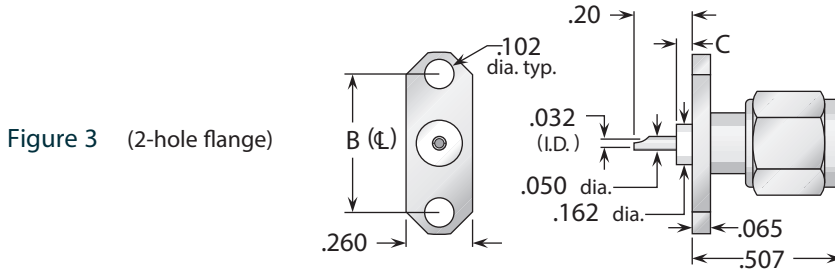
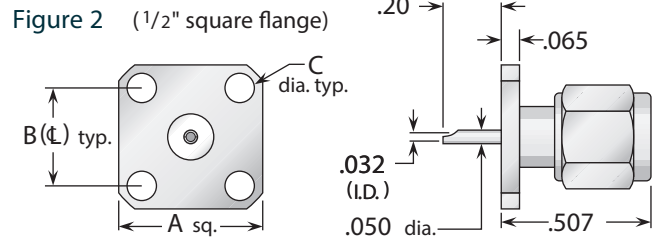
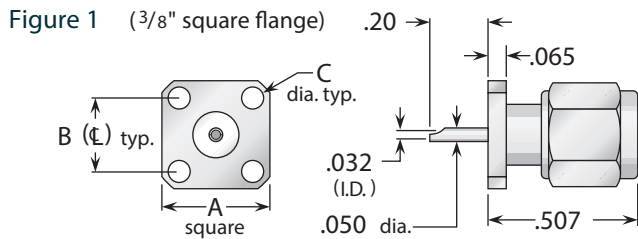

Figure 3 (2-hole flange)

Figure	Dimensions			Mounting Figure	Plating		Delta P/N
	A	B	C		Body	Contact	
1	.375	.250	.067	91	Gold	Gold (C)	1359000G911-013
1	.375	.250	.067	91	Passivated	Gold (C)	1359000K911-013
2	.500	.340	.102	05	Gold	Gold (C)	1359000G051-010
2	.500	.340	.102	05	Passivated	Gold (C)	1359000K051-010
3	.625	.481	.000	92A	Gold	Gold (C)	1359000G921-017
3	.625	.481	.000	92A	Passivated	Gold (C)	1359000K921-017
3	.625	.481	.025	92A	Passivated	Gold (C)	1359000G921-018
3	.625	.481	.025	92A	Passivated	Gold (C)	1359000K921-018

• See page 208 for mounting dimensions. • (C) in contact plating column indicates captive contact.

Panel Plug Receptacles - Tab Contact

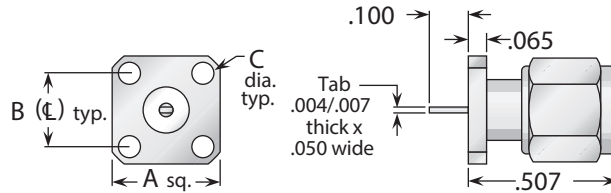

Figure 1
($\frac{3}{8}$ " square flange)

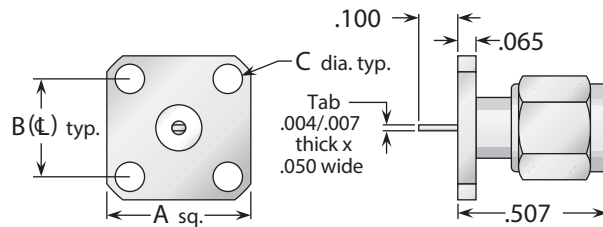

Figure 2
($\frac{1}{2}$ " square flange)

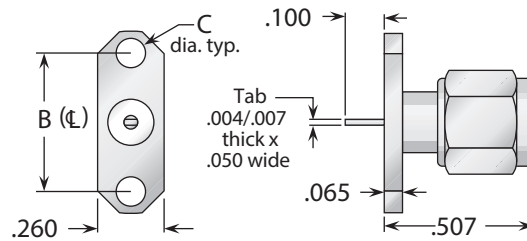

Figure 3
(2-hole flange)

Figure	Dimensions			Mounting Figure	Plating		Delta P/N
	A	B	C		Body	Contact	
1	.375	.250	.067	91	Gold	Gold	1359000G910-002
1	.375	.250	.067	91	Passivated	Gold	1359000K910-002
1	.375	.250	.067	91	Gold	Gold (C)	1359000G911-014
1	.375	.250	.067	91	Passivated	Gold (C)	1359000K911-014
2	.500	.340	.102	05	Gold	Gold	1359000G050-005
2	.500	.340	.102	05	Passivated	Gold	1359000K050-005
2	.500	.340	.102	05	Gold	Gold (C)	1359000G051-045
2	.500	.340	.102	05	Passivated	Gold (C)	1359000K051-045
3	.625	.481	.102	92A	Gold	Gold	1359000G920-001
3	.625	.481	.102	92A	Passivated	Gold	1359000K920-001
3	.625	.481	.102	92A	Gold	Gold (C)	1359000G921-019
3	.625	.481	.102	92A	Passivated	Gold (C)	1359000K921-019

- See page 208 for mounting dimensions.
- (C) in contact plating column indicates captive contact (epoxy captivated).
- All items available with other flange, contact, and insulator configurations.

Panel Plug Receptacles - Slotted Contact

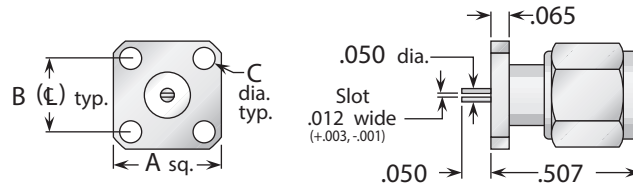

Figure 1
(3/8" square flange)

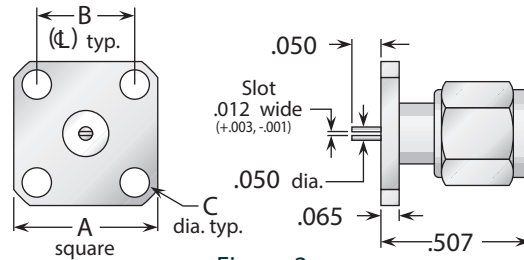

Figure 2
(1/2" square flange)

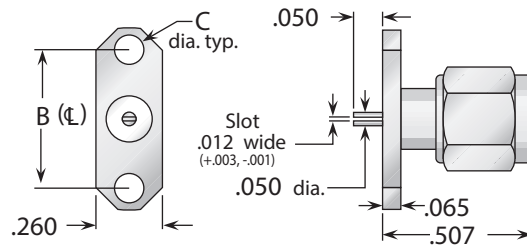

Figure 3
(2-hole flange)

Other Standard Slot Widths

Our other standard slot widths for these connectors (.018" and .036") are readily available—call for part numbers.

Figure	Dimensions			Mounting Figure	Plating		Delta P/N
	A	B	C		Body	Contact	
1	.375	.250	.067	91	Gold	Gold	1359000G910-004
1	.375	.250	.067	91	Passivated	Gold	1359000K910-004
1	.375	.250	.067	91	Gold	Gold (C)	1359000G911-023
1	.375	.250	.067	91	Passivated	Gold (C)	1359000K911-023
2	.500	.340	.102	05	Gold	Gold	1359000G050-007
2	.500	.340	.102	05	Passivated	Gold	1359000K050-007
2	.500	.340	.102	05	Gold	Gold (C)	1359000G051-038
2	.500	.340	.102	05	Passivated	Gold (C)	1359000K051-038
3	.625	.481	.102	92A	Gold	Gold	1359000G920-002
3	.625	.481	.102	92A	Passivated	Gold	1359000K920-002
3	.625	.481	.102	92A	Gold	Gold (C)	1359000G921-020
3	.625	.481	.102	92A	Passivated	Gold (C)	1359000K921-020

See page 208 for mounting dimensions. • (C) in contact plating column indicates captive contact (epoxy captivated).
All items available with other flange, contact, and insulator configurations.

Panel Plug Receptacle - Post Contact

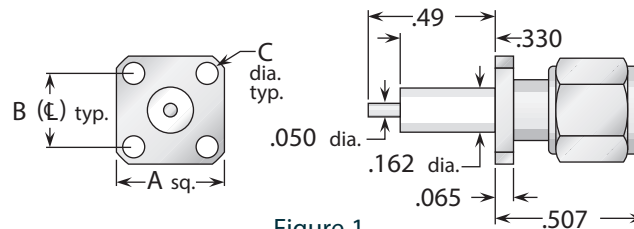

Figure 1
(3/8" square flange)

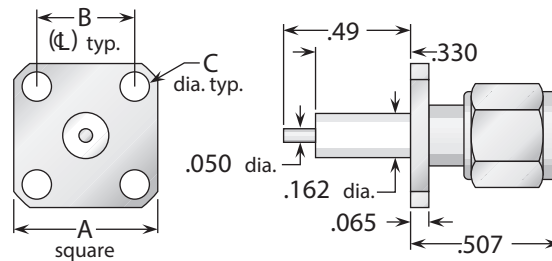

Figure 2
(1/2" square flange)

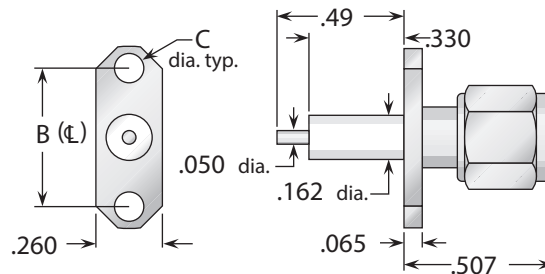

Figure 3
(2-hole flange)

Figure	Dimensions			Mounting Figure	Plating		Delta P/N
	A	B	C		Body	Contact	
1	.375	.250	.067	91	Gold	Gold	1359000G910-003
1	.375	.250	.067	91	Passivated	Gold	1359000K910-003
1	.375	.250	.067	91	Gold	Gold (C)	1359000G911-015
1	.375	.250	.067	91	Passivated	Gold (C)	1359000K911-015
2	.500	.340	.102	05	Gold	Gold	1359000G050-000
2	.500	.340	.102	05	Passivated	Gold	1359000K050-002
2	.500	.340	.102	05	Gold	Gold (C)	1359000G051-004
2	.500	.340	.102	05	Passivated	Gold (C)	1359000K051-004
3	.625	.481	.102	92A	Gold	Gold	1323000G920-000
3	.625	.481	.102	92A	Passivated	Gold	1323000K920-000
3	.625	.481	.102	92A	Gold	Gold (C)	1323000G921-001
3	.625	.481	.102	92A	Passivated	Gold (C)	1323000K921-001

- See page 208 for mounting dimensions.
- (C) in contact plating column indicates captive contact (epoxy captivated).
- All items available with other flange, contact, and insulator configurations.

Dummy Receptacles

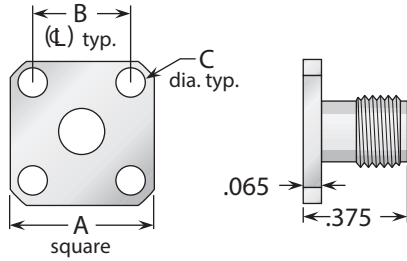

Figure 1
(1/2" square flange)

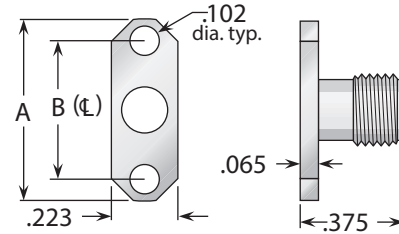

Figure 2
(2-hole flange)

Figure	Dimensions			Mounting Figure	Plating		Delta P/N
	A	B	C		Body	Contact	
1	.500	.340	.102	05	Gold	—	1363000G050-001
1	.500	.340	.102	05	Passivated	—	1363000K050-002
2	.625	.481	.102	92	Gold	—	1363000G920-000
2	.625	.481	.102	92	Passivated	—	1363000K920-000

Dust Caps

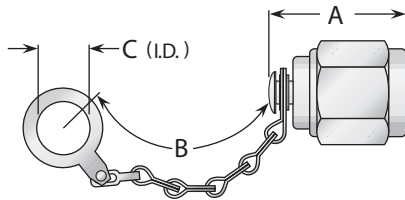

Figure 1
(Shown with safety chain)

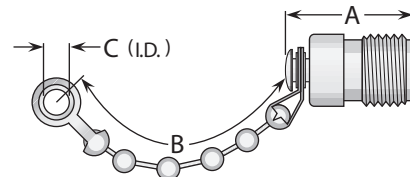

Figure 2
(Shown with bead chain)

See page 195 for MIL-PRF-39012 QPL versions.

Figure	Dimensions			Features	Plating		Delta P/N
	A	B	C		Body	Contact	
1	.500	2.25	.144	Bead chain	Gold	—	1332000G000-000
1	.500	2.25	.144	Bead chain	Passivated	—	1332000K000-000
1	.275	—	—	No chain	Passivated	—	1332000K00A-001
1	.500	3.25	.281	Safety chain	Passivated	—	1332000K00B-003
1	.330	—	—	No chain / shorting type	Passivated	Passivated	1332000K00C-000
2	.500	2.25	.144	Bead chain	Gold	—	1333000G000-000
2	.500	2.25	.144	Bead chain	Passivated	—	1333000K000-000
2	.390	—	—	No chain	Passivated	—	1333000K00A-000

• See page 208 for mounting dimensions. • Dust caps are available with other chain styles and lengths.

Bulkhead Mounted Jack-Jack Adapters (Connects Two Plugs)

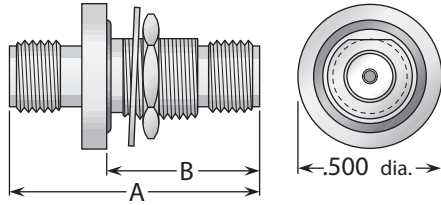

Figure 1
(Hermetically sealed, with mounting gasket)

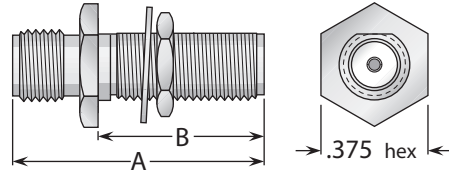

Figure 2
(Non-hermetic, no mounting gasket)

Figure	Dimensions		Max. Panel	Mounting Figure	Plating		Delta P/N
	A	B			Body	Contact	
1	.875	.555	.190	66	Gold	Gold (C)	1326000G678-000
2	.875	.575	.250	67	Gold	Gold (C)	1326000G821-000
2	.875	.575	.250	67	Passivated	Gold (C)	1326000K821-001

Straight Adapters

Figure 1
(Straight jack-jack;
connects two plugs)

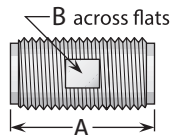

Figure 2
(Straight plug-plug;
connects two jacks)

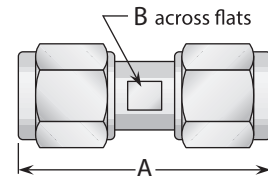

Figure 3
(Straight jack-plug;
connects one plug
and one jack)

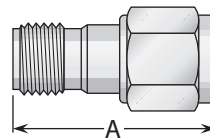

Figure	Dimensions		Plating		Delta P/N
	A	B	Body	Contact	
1	.500	.218	Gold	Gold (C)	1328000G000-000
1	.500	.218	Passivated	Gold (C)	1328000K000-001
2	.875	.218	Gold	Gold (C)	1327000G000-000
2	.875	.218	Passivated	Gold (C)	1327000K000-002
3	.720	—	Gold	Gold (C)	1334000G000-000
3	.720	—	Passivated	Gold (C)	1334000K000-000

• (C) in contact plating column indicates captive contact.

• See page 208 for mounting dimensions.

Right Angle & Tee Adapters

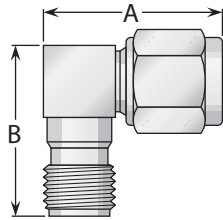

Figure 1
 (Right angle plug-jack;
 connects one plug and one jack)

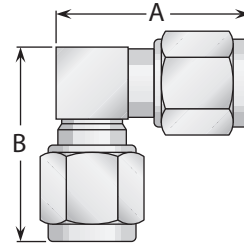

Figure 2
 (Right angle plug-plug;
 connects two jacks)

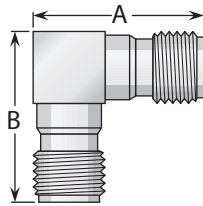

Figure 3
 (Right angle jack-jack;
 connects two plugs)

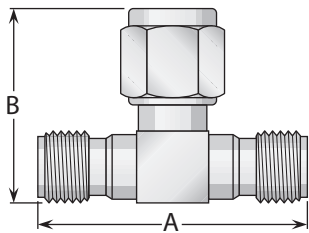

Figure 4
 (Tee jack-plug-jack;
 connects two plugs and one jack)

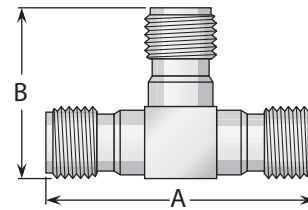

Figure 5
 (Tee jack-jack-jack;
 connects three plugs)

Figure	Dimensions		Plating		Delta P/N
	A	B	Body	Contact	
1	.625	.585	Gold	Gold (C)	1329000G000-000
1	.625	.585	Passivated	Gold (C)	1329000K000-000
2	.675	.675	Gold	Gold (C)	1337000G000-001
2	.675	.675	Passivated	Gold (C)	1337000K000-001
3	.585	.585	Gold	Gold (C)	1395000G000-000
3	.585	.585	Passivated	Gold (C)	1395000K000-000
4	.920	.630	Gold	Gold (C)	1330000G000-000
4	.920	.630	Passivated	Gold (C)	1330000K000-000
5	1.00	.590	Gold	Gold (C)	1349000G000-000
5	1.00	.590	Passivated	Gold (C)	1349000K000-000

(C) in contact plating column indicates captive contact.

General Description

Delta E-Line brass SMA connectors are subminiature, 50 Ω impedance connectors with 1/4"-36 threaded coupling. Their use of brass for body parts provides lower cost while retaining electrical performance similar to that of stainless steel SMA counterparts.

If your application does not require the 500 mating cycles of service life provided by stainless steel SMA connectors, E-Line SMAs can fulfill your needs at a reduced cost. For additional economy, nickel-plated bodies can be specified instead of gold plating.

E-Line brass SMA connectors can be used with semi-rigid cables in applications up to 18 GHz, or miniature flexible cables up to 12.4 GHz.

Our E-Line brass SMA product line is still growing, so please call if you don't see what you need.

E-Line Brass SMA Configurations

Cable Plugs for Semi-Rigid Cable	124	Panel Jack Receptacles (Post Contact)	126
Straight Cable Jacks for Semi-Rigid Cable	124	Panel Jack Receptacles (Tab Contact)	126
Bulkhead Cable Jacks for Semi-Rigid Cable	124	Bulkhead Jack Receptacles	127
Panel Cable Jacks for Semi-Rigid Cable	124	Printed-Circuit Board Receptacles	127
Cable Plugs for Flexible Cable	125	Panel Plug Receptacles (Solder Pot Contact)	128
Straight Cable Jacks for Flexible Cable	125	Panel Plug Receptacles (Post Contact)	128
Bulkhead Cable Jacks for Flexible Cable	125	Panel Plug Receptacles (Tab Contact)	128
Panel Jack Receptacles (Solder Pot Contact)	126	In-Series Adapters	129

E-Line Brass SMA Specifications*

Plug Interface**

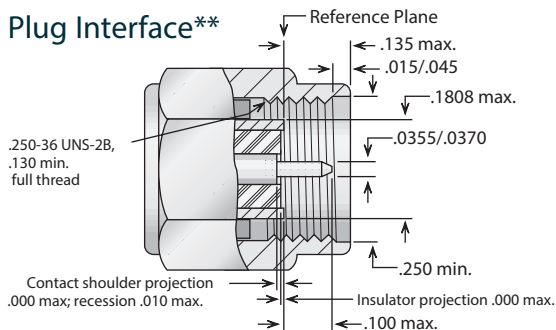

Jack Interface**

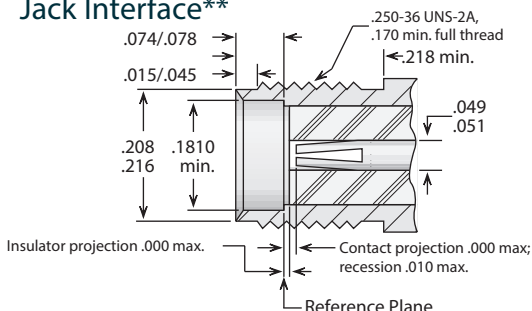

**Some proportions altered to illustrate detail.

Electrical:

Nominal Impedance: 50 ohms.

Frequency Range: DC-18 GHz (with semi-rigid cable);
DC-12.4 GHz (with flexible cable).

Voltage Rating: 335-500 volts RMS (dependent on cable).

Dielectric Withstanding

Voltage : 500-1500 volts RMS (dependent on cable).

Insulation Resistance: 5,000 megohms.

Materials/Finishes:

Insulators: Teflon per ASTM D1710.

Male Contacts: Brass per ASTM B16, or

Beryllium Copper per ASTM B196.

Female Contacts: Beryllium Copper per ASTM B196.

Contact Plating : Gold per MIL-DTL-45204.

Gaskets: Silicone rubber per ZZ-R-765,

Class II, Grade 50.

Other Metal Parts: Brass per ASTM B16 or equivalent; gold plated per MIL-DTL-45204, or nickel plated per AMS-QQ-N-290.

All other specifications are in accordance with the latest issues of MIL-PRF-39012, or MIL-A-55339, or other applicable MIL specifications, and interfaces are in accordance with MIL-STD-348.

*These specifications are typical and may not apply to all connectors. Detailed specifications for individual connectors are available on request.

Straight & Right Angle Plugs - For Semi-Rigid Cable

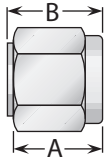

Figure 1
(Straight plug—direct solder)

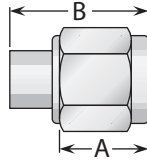

Figure 2
(Straight plug—direct solder)

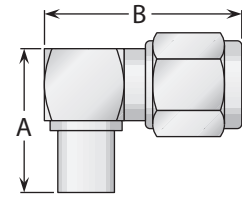

Figure 3
(Right angle plug—direct solder)

Cable Group	Figure	Dimensions		Plating		Delta P/N	Assembly Procedure/ Trim Code
		A	B	Body	Contact		
13	1	.330	.344	Gold*	None ⁽¹⁾	1301031G003-502	G/01
13	2	.459	.330	Gold*	None ⁽¹⁾	1301031G003-501	G/01
13	2	.330	.459	Gold*	Gold	1301031G003-500	H/03
13	3	.460	.630	Gold*	Gold (C)	1305031G003-500	J/02
14	2	.330	.459	Gold*	Gold	1301025G003-500	H/03
14	3	.460	.630	Gold*	Gold (C)	1305025G003-500	J/02

⁽¹⁾ Cable center conductor used as contact.

Straight, Panel & Bulkhead Jacks - For Semi-Rigid Cable

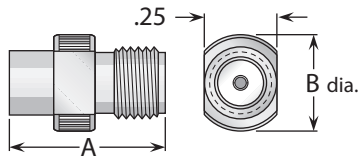

Figure 1
(Straight jack, direct solder)

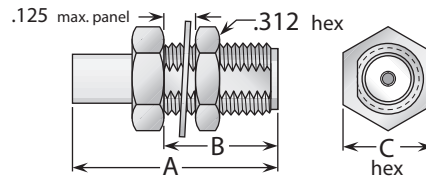

Figure 2
(Bulkhead mount, direct solder)

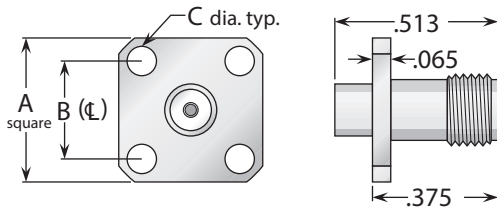

Figure 3
(4-hole flange, direct solder)

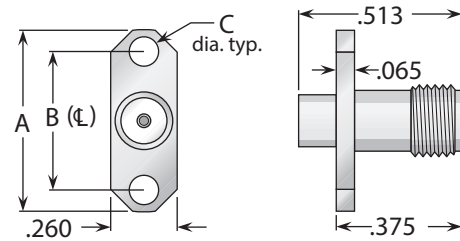

Figure 4
(2-hole flange, direct solder)

Cable Group	Fig.	Dimensions			Mounting Figure	Plating		Delta P/N	Assembly Procedure/ Trim Code
		A	B	C		Body	Contact		
13	1	.500	.335	—	—	Gold*	Gold	1308031G003-500	H/01
13	2	.850	.500	.312	67	Gold*	Gold	1317031G673-500	H/04
13	3	.500	.340	.102	05	Gold*	Gold	1311031G053-500	H/01
13	4	.625	.481	.102	92A	Gold*	Gold	1311031G923-500	H/01
14	1	.500	.335	—	—	Gold*	Gold	1308025G003-500	H/01
14	2	.850	.500	.312	67	Gold*	Gold	1317025G673-500	H/04
14	3	.500	.340	.102	05	Gold*	Gold	1311025G053-500	H/01
14	4	.625	.481	.102	92A	Gold*	Gold	1311025G923-500	H/01

- * Also available with nickel-plated body—change G in Delta part number to N.
- (C) in contact plating column indicates captive contact.
- See page 209 for cable groups.
- Assembly procedures start on page 210.
- See page 208 for mounting dimensions.

Straight & Right Angle Plugs - Crimp Type For Flexible Cable

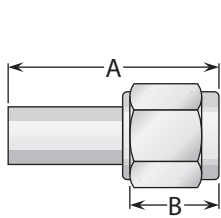

Figure 1
(Straight plug)

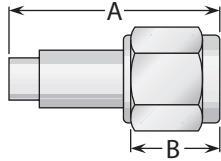

Figure 2
(Straight plug)

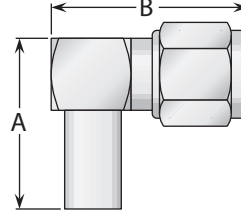

Figure 3
(Right angle plug)

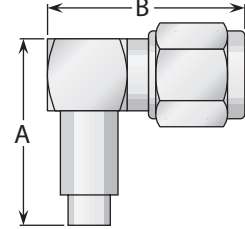

Figure 4
(Right angle plug)

Cable Group	Figure	Dimensions		Plating		Delta P/N	Assembly Procedure/ Trim Code
		A	B	Body	Contact		
5	1	.880	.330	Gold*	Gold	1303017G000-500	K/05
5	3	.650	.630	Gold*	Gold (C)	1307017G001-500	L/03
6	1	.880	.330	Gold*	Gold	1303013G000-500	K/05
6	3	.650	.630	Gold*	Gold (C)	1307013G001-500	L/03
9	1	.750	.330	Gold*	Gold	1303037G000-500	K/03
9	3	.650	.630	Gold*	Gold (C)	1307037G001-500	L/03
10	1	.750	.330	Gold*	Gold	1303100G000-500	K/06
10	3	.650	.630	Gold*	Gold (C)	1307100G001-500	L/03
11	2	.760	.330	Gold*	Gold	1303038G000-500	***
11	4	.650	.630	Gold*	Gold (C)	1307038G001-500	L/03

Straight & Bulkhead Jacks - Crimp Type For Flexible Cable

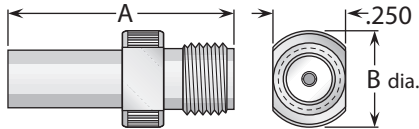

Figure 1 (Straight jack)

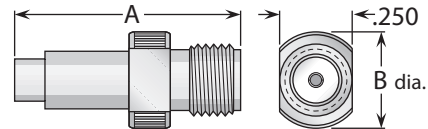

Figure 2 (Straight jack)

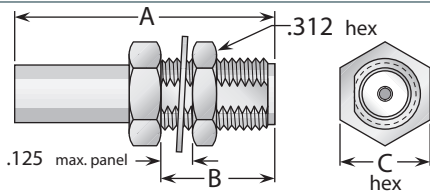

Figure 3 (Bulkhead jack)

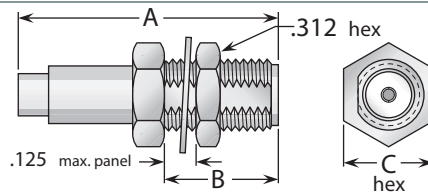

Figure 4 (Bulkhead jack)

Cable Group	Fig.	Dimensions			Mounting Figure	Plating		Delta P/N	Assembly Procedure/ Trim Code
		A	B	C		Body	Contact		
5	1	.760	.335	—	—	Gold*	Gold	1310017G000-500	K/08
5	3	.990	.500	.312	67	Gold*	Gold	1319017G670-500	K/10
6	1	.760	.335	—	—	Gold*	Gold	1310013G000-500	K/08
6	3	.990	.500	.312	67	Gold*	Gold	1319013G670-500	K/10
9	1	.740	.335	—	—	Gold*	Gold	1310037G000-500	K/08
9	3	.990	.500	.312	67	Gold*	Gold	1319037G670-500	K/10
10	1	.740	.335	—	—	Gold*	Gold	1310100G000-500	K/08
10	3	.990	.500	.312	67	Gold*	Gold	1319100G670-500	K/10
11	2	.740	.335	—	—	Gold*	Gold	1310038G000-500	***
11	4	.990	.500	.312	67	Gold*	Gold	1319038G670-500	***

• * Also available with nickel-plated body—change G in Delta part number to N. • (C) in contact plating column indicates captive contact.
 • See page 209 for cable groups. • Assembly procedures start on page 210. • See page 208 for mounting dimensions.

Panel Jack Receptacles

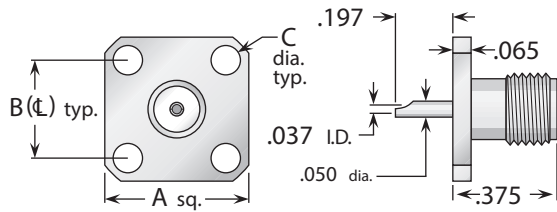

Figure 1
(Solder pot contact—square flange)

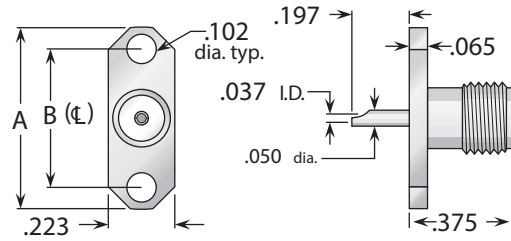

Figure 2
(Solder pot contact—2-hole flange)

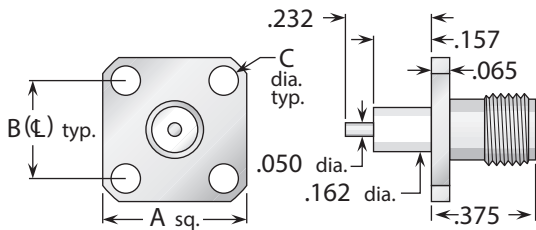

Figure 3
(Post contact—square flange)

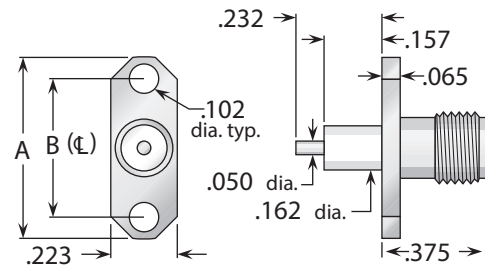

Figure 4
(Post contact—2-hole flange)

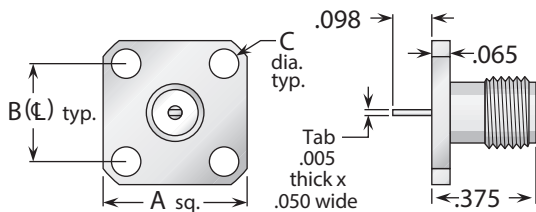

Figure 5
(Tab contact—square flange)

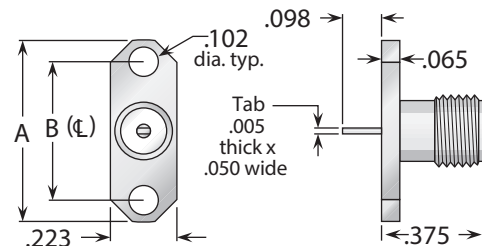

Figure 6
(Tab contact—2-hole flange)

Figure	Dimensions			Mounting Figure	Plating		Delta P/N
	A	B	C		Body	Contact	
1	.500	.340	.102	05	Gold*	Gold (C)	1313000G051-500
2	.625	.481	.102	92	Gold*	Gold (C)	1313000G921-500
3	.500	.340	.102	05	Gold*	Gold (C)	1358000G051-500
4	.625	.481	.102	92	Gold*	Gold (C)	1358000G921-500
5	.500	.340	.102	05	Gold*	Gold (C)	1358000G051-501
6	.625	.481	.102	92	Gold*	Gold (C)	1358000G921-501

- * Also available with nickel-plated body—change G in Delta part number to N.
- See page 208 for mounting dimensions. • (C) in contact plating column indicates captive contact (mechanical captivation).
- All items available with other flange, contact, and insulator configurations.

Bulkhead Jack Receptacles

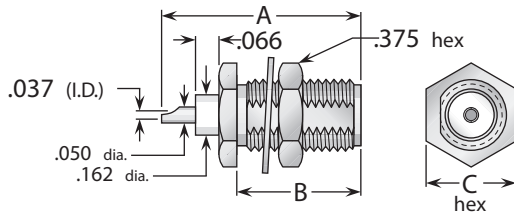

Figure 1 (Rear mount, solder pot contact, no mounting gasket)

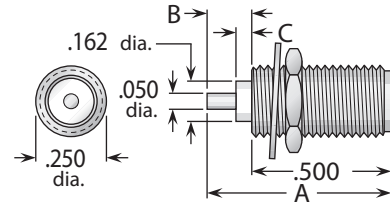

Figure 2 (Round body, post contact)

Figure	Dimensions			Max. Panel	Mounting Figure	Plating		Delta P/N
	A	B	C			Body	Contact	
1	.670	.450	.375	.125	67	Gold	Gold (C)	1321000G671-500
2	.660	.157	.075	.125	82	Gold	Gold (C)	1321000G821-500
2	.620	.118	.000	.125	82	Gold	Gold (C)	1321000G821-501

Printed-Circuit Board Receptacles

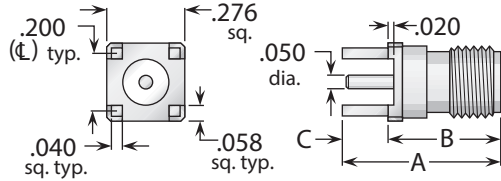

Figure 1 (Straight jack)

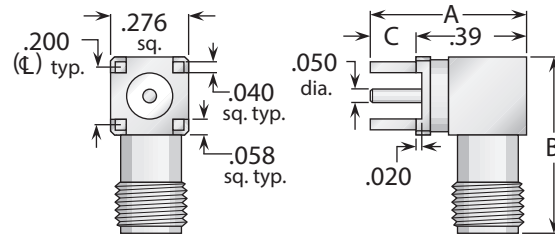

Figure 2 (Right angle jack)

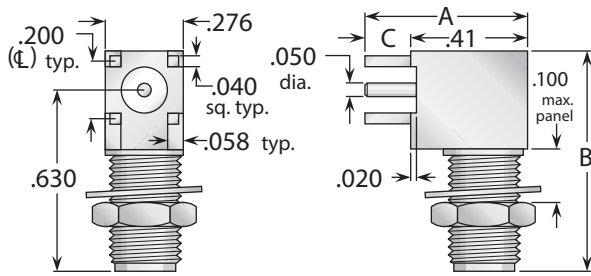

Figure 3 (Right angle bulkhead jack)

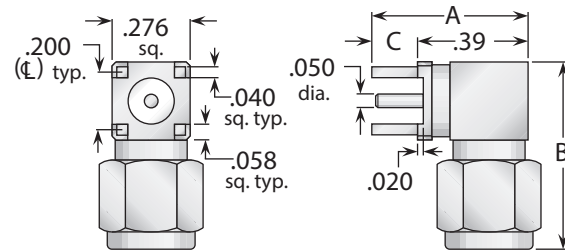

Figure 5 (Right angle plug)

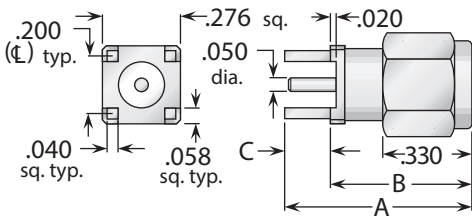

Figure 4 (Straight plug)

Figure	Dimensions			Max. Board	Mounting Figure	Plating		Delta P/N
	A	B	C			Body	Contact	
1	.550	.394	.155	.125	PCB05	Gold*	Gold (C)	1367000G001-500
2	.540	.594	.155	.125	PCB05	Gold*	Gold (C)	1369000G001-500
3	.560	.756	.155	.125	PCB05/82	Gold*	Gold (C)	1369000G821-500
4	.650	.494	.155	.125	PCB05	Gold*	Gold (C)	1368000G001-500
5	.540	.650	.155	.125	PCB05	Gold*	Gold (C)	1370000G001-500

* Also available with nickel-plated body—change G in Delta part number to N.

• See page 208 for mounting dimensions. • (C) in contact plating column indicates captive contact (mechanical captivation).

Panel Plug Receptacles

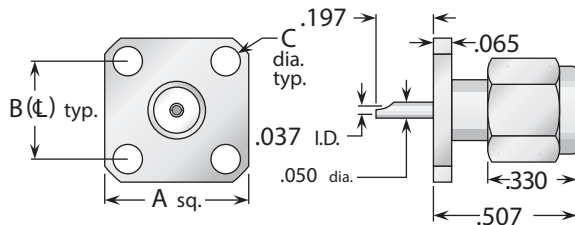

Figure 1
(Solder pot contact—square flange)

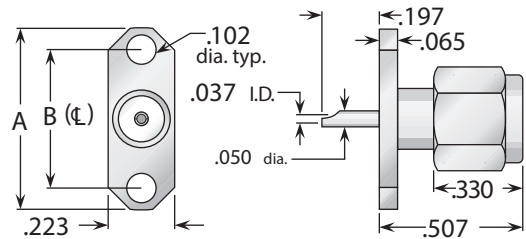

Figure 2
(Solder pot contact—2-hole flange)

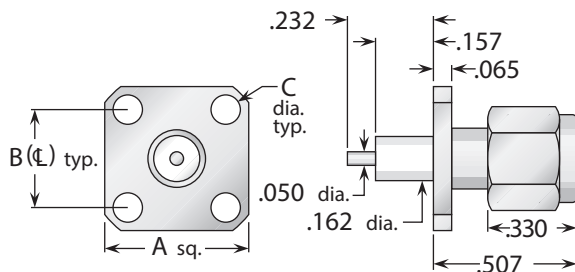

Figure 3
(Post contact—square flange)

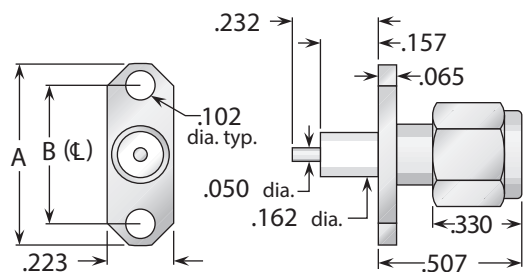

Figure 4
(Post contact—2-hole flange)

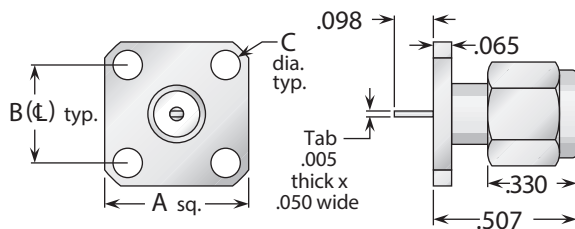

Figure 5
(Tab contact—square flange)

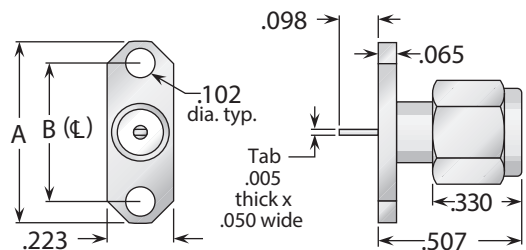

Figure 6
(Tab contact—2-hole flange)

Figure	Dimensions			Mounting Figure	Plating		Delta P/N
	A	B	C		Body	Contact	
1	.500	.340	.102	05	Gold*	Gold (C)	1323000G051-500
2	.625	.481	.102	92	Gold*	Gold (C)	1323000G921-500
3	.500	.340	.102	05	Gold*	Gold (C)	1359000G051-500
4	.625	.481	.102	92	Gold*	Gold (C)	1359000G921-500
5	.500	.340	.102	05	Gold*	Gold (C)	1359000G051-501
6	.625	.481	.102	92	Gold*	Gold (C)	1359000G921-501

- * Also available with nickel-plated body—change G in Delta part number to N.
- See page 208 for mounting dimensions.
- (C) in contact plating column indicates captive contact (mechanical captivation).
- All items available with other flange, contact, and insulator configurations.

Straight, Right Angle, & Tee Adapters

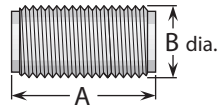

Figure 1
(Straight jack-jack; connects two plugs)

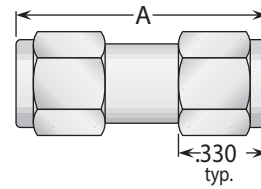

Figure 2
(Straight plug-plug; connects two jacks)

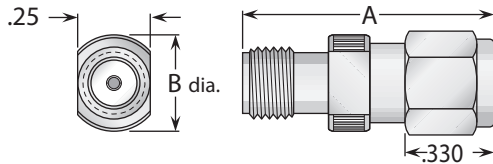

Figure 3
(Straight jack-plug; connects one plug and one jack)

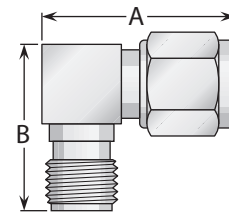

Figure 4
(Right angle plug-jack; connects one plug and one jack)

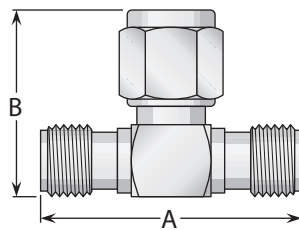

Figure 5
(Tee jack-plug-jack; connects two plugs and one jack)

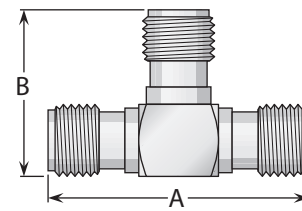

Figure 6
(Tee jack-jack-jack; connects three plugs)

Figure	Dimensions		Plating		Delta P/N
	A	B	Body	Contact	
1	.500	.250	Gold*	Gold (C)	1328000G001-500
2	.900	—	Gold*	Gold (C)	1327000G001-500
3	.860	.335	Gold*	Gold (C)	1334000G001-500
4	.654	.594	Gold*	Gold (C)	1329000G001-500
5	.913	.654	Gold*	Gold (C)	1330000G001-500
6	.913	.594	Gold*	Gold (C)	1338000G001-500

- * Also available with nickel-plated body—change G in Delta part number to N.
- (C) in contact plating column indicates captive contact (mechanical captivation).

General Description

Delta SMB connectors are subminiature, 50 Ω impedance connectors with snap-on coupling. They are best suited for use with cables in the range of .070" to .120" diameter, such as RG-178 and RG-316/U.

Delta SMC connectors (page 134) are similar in size and construction to SMB series, but employ #10–32 threaded coupling, and have a higher upper frequency limit than SMB.

All Delta SMB and SMC connectors are available with gold-plated bodies, or with nickel-plated bodies for economy.

Adapters between SMB and other series are shown starting on page 176.

As with our other connector series, Delta's customer-driven design results in SMB and SMC series connectors with practical and unique features that make your design and assembly process easier. Some of these include:

- SMB PressMount receptacles (page 133) mount securely in a single round hole, saving space on your components and reducing your housing fabrication costs.
- SMB and SMC panel receptacles with flange sizes to match the same hole pattern as standard SMA connectors, letting you drill one hole pattern and mount SMB, SMC, BNC, N, SMA, or TNC series connectors as needed.

Our SMB and SMC series product line is still growing, so please call if you don't see what you need.

SMB Configurations

Straight Cable Plugs	131
Right Angle Cable Plugs.....	131
Bulkhead Cable Jacks	131
Bulkhead Jack Receptacles.....	132
Panel Jack Receptacles (square flange)	132
PressMount receptacles	133
Printed-Circuit Board Receptacles	133

SMC Configurations

Straight Cable Plugs	134
Right Angle Cable Plugs.....	134
Bulkhead Cable Jacks	134
Bulkhead Jack Receptacles.....	135
Panel Jack Receptacles (square flange)	135
Printed-Circuit Board Receptacles	135

SMB & SMC Specifications*

SMB Interfaces**

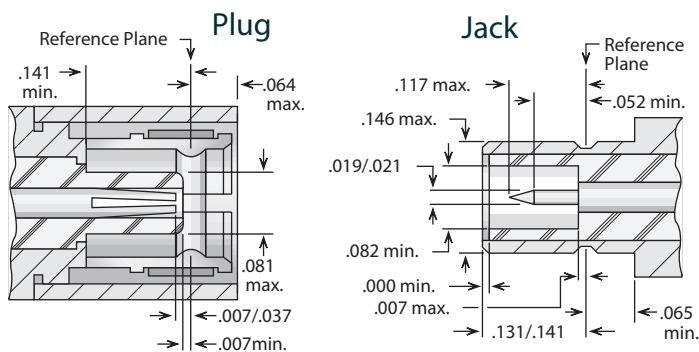

Electrical:

Nominal Impedance: 50 ohms.

Frequency Range: SMB: DC–4 GHz.

SMC: DC–10 GHz.

Voltage Rating: 250 volts RMS (when used with RG-178-class cables); 335 volts RMS (when used with RG-316-class cables).

Dielectric Withstanding

Voltage : 750 volts RMS (when used with RG-178-class cables); 1,000 volts RMS (when used with RG-316-class cables).

Insulation Resistance: 1,000 megohms.

Materials/Finishes:

Insulators: Teflon per ASTM D1710.

Male Contacts: Brass per ASTM B16.

Female Contacts: Beryllium Copper per ASTM B196.

Contact Plating : Gold per MIL-DTL-45204.

Gaskets: Silicone rubber per ZZ-R-765, Class II, Grade 50.

Other Metal Parts: Brass per ASTM B16, plated:
Gold per MIL-DTL-45208, or
Nickel per AMS-QQ-N-290.

SMC Interfaces**

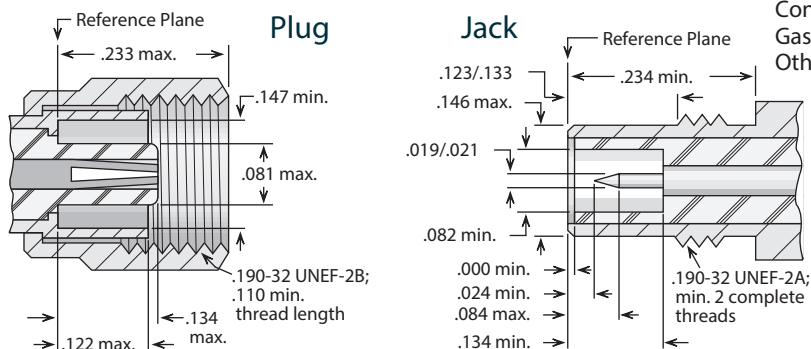

All other specifications are in accordance with the latest issues of MIL-PRF-39012, or MIL-A-55339, or other applicable MIL specifications, and interfaces are in accordance with MIL-STD-348.

*These specifications are typical and may not apply to all connectors. Detailed specifications for individual connectors are available on request.

**Some proportions altered to illustrate detail.

Straight & Right Angle Plugs - For Flexible Cable

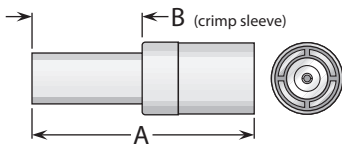

Figure 1
(Crimp type)

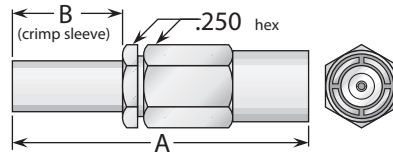

Figure 2
(Crimp type)

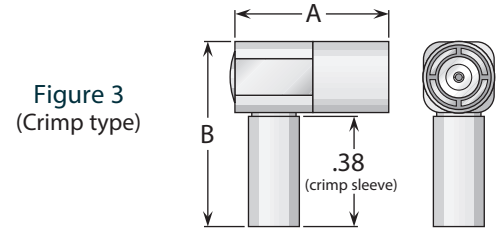

Figure 3
(Crimp type)

Cable Group	Figure	Dimensions		Plating		Delta P/N	Assembly Procedure/ Trim Code
		A	B	Body	Contact		
9	1	.800	.380	Gold	Gold	2403037G000-002	B/28
9	1	.800	.380	Nickel	Gold	2403037N000-002	B/28
9	2	1.03	.380	Gold	Gold (C)	2402037G001-000	***
9	2	1.03	.380	Nickel	Gold (C)	2402037N001-000	***
9	3	.520	.630	Gold	Gold (C)	2407037G001-000	B/29
9	3	.520	.630	Nickel	Gold (C)	2407037N001-000	B/29
10	1	.800	.380	Gold	Gold	2403100G000-000	B/28
10	1	.800	.380	Nickel	Gold	2403100N000-000	B/28
10	2	1.03	.380	Gold	Gold (C)	2402100G001-000	***
10	2	1.03	.380	Nickel	Gold (C)	2402100N001-000	***
10	3	.520	.630	Gold	Gold (C)	2407100G001-000	B/29
10	3	.520	.630	Nickel	Gold (C)	2407100N001-000	B/29
11	1	.800	.380	Gold	Gold	2403038G000-001	***
11	1	.800	.380	Nickel	Gold	2403038N000-001	***
11	2	1.03	.380	Gold	Gold (C)	2402038G001-000	***
11	2	1.03	.380	Nickel	Gold (C)	2402038N001-000	***
11	3	.520	.630	Gold	Gold (C)	2407038G001-001	B/29
11	3	.520	.630	Nickel	Gold (C)	2407038N001-001	B/29

Bulkhead Jack - For Flexible Cable

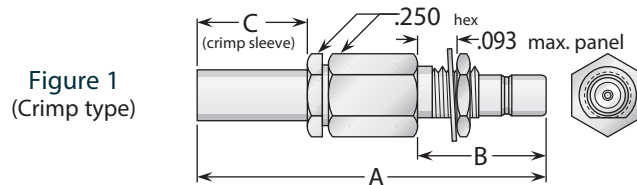

Figure 1
(Crimp type)

Cable Group	Fig.	Dimensions			Mounting Figure	Plating		Delta P/N	Assembly Procedure/ Trim Code
		A	B	C		Body	Contact		
9	1	1.17	.426	.380	68	Gold	Gold (C)	2419037G681-000	***
9	1	1.17	.426	.380	68	Nickel	Gold (C)	2419037N681-000	***
10	1	1.17	.426	.380	68	Gold	Gold (C)	2419100G681-000	***
10	1	1.17	.426	.380	68	Nickel	Gold (C)	2419100N681-000	***
11	1	1.17	.426	.380	68	Gold	Gold (C)	2419038G681-000	***
11	1	1.17	.426	.380	68	Nickel	Gold (C)	2419038N681-000	***

- See page 209 for cable groups.
- Assembly procedures start on page 210.
- ***Contact factory for cable assembly instructions.
- See page 208 for mounting dimensions.
- (C) in contact plating column indicates captive contact.

Bulkhead Jack Receptacles

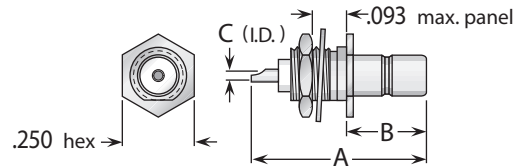

Figure 1

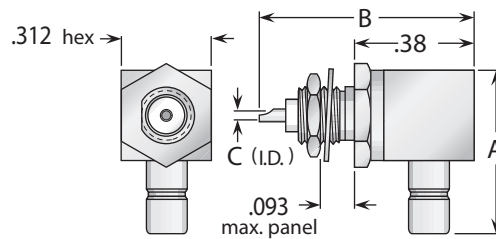

Figure 2

Figure	Dimensions			Mounting Figure	Plating		Delta P/N
	A	B	C		Body	Contact	
1	.590	.265	.035	68	Gold	Gold (C)	2420000G681-000
1	.590	.265	.035	68	Nickel	Gold (C)	2420000N681-000
2	.590	.750	.022	68	Gold	Gold (C)	2422000G681-000
2	.590	.750	.022	68	Nickel	Gold (C)	2422000N681-000

Panel Jack Receptacles

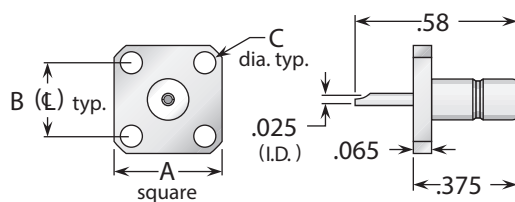

Figure 1
(³/₈" square flange)

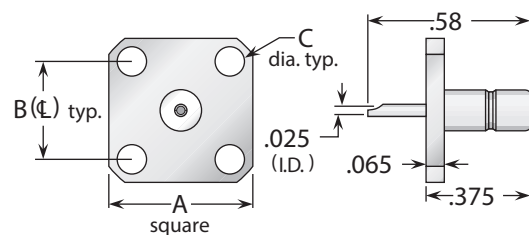

Figure 2
(¹/₂" square flange)

Figure	Dimensions			Mounting Figure	Plating		Delta P/N
	A	B	C		Body	Contact	
1	.375	.232	.093	91A	Gold	Gold (C)	2413000G911-000
1	.375	.232	.093	91A	Nickel	Gold (C)	2413000N911-000
2	.500	.340	.102	05	Gold	Gold (C)	2413000G051-000
2	.500	.340	.102	05	Nickel	Gold (C)	2413000N051-000

• See page 208 for mounting dimensions. • (C) in contact plating column indicates captive contact.

Printed-Circuit Board Receptacles

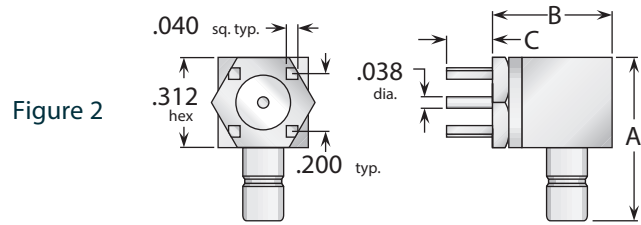
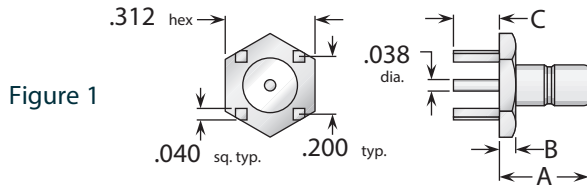
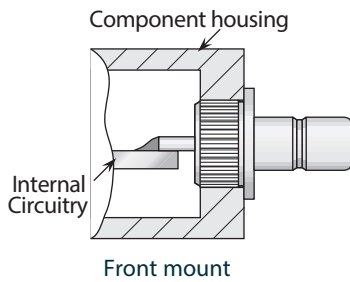

Figure	Dimensions			Max. Board	Mounting Figure	Plating		Delta P/N
	A	B	C			Body	Contact	
1	.300	.060	.155	.100	PCB06	Gold	Gold (C)	2468000G001-000
1	.300	.060	.155	.100	PCB06	Nickel	Gold (C)	2468000N001-000
2	.590	.375	.155	.100	PCB06	Gold	Gold (C)	2470000G00E-000
2	.590	.375	.155	.100	PCB06	Nickel	Gold (C)	2470000N00E-000

Press Mount Receptacles

Delta PressMount Receptacles



These connectors eliminate the need for complicated mounting hole patterns and mounting hardware. They are simply pressed into a single through hole, and the precisely-engineered knurled mounting section provides retention strength far greater than normal mating and unmating forces. An integral shoulder provides a positive stop when mounting.

PressMounts are available for a wide variety of Delta connector series, and can be used in packages as small as the outer diameter of the connector body.

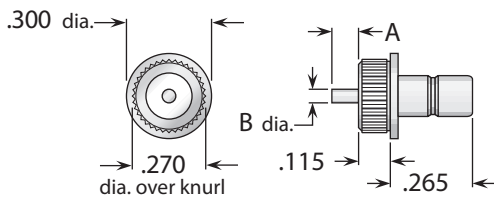
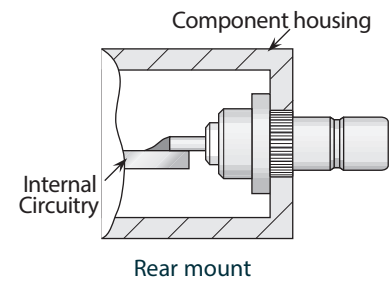

Figure 1
(Post contact, front mount, stainless steel body)

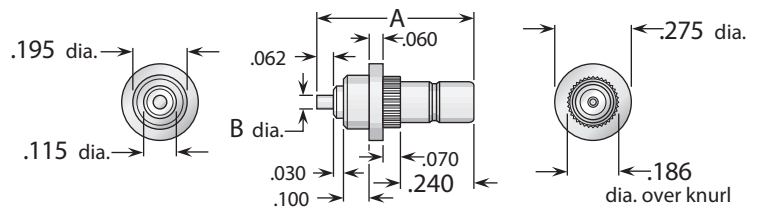

Figure 2
(Post contact, rear mount, brass body)

Figure	Dimensions		Min. Panel	Mounting Hole	Plating		Delta P/N
	A	B			Body	Contact	
1	.062	.050	.100	.267 ±.001 dia.	Passivated	Gold (C)	2420000K911-001
2	.500	.060	.062	.182 ±.001 dia.	Gold	Gold (C)	2421000G911-000

• See page 208 for mounting dimensions. • (C) in contact plating column indicates captive contact.

Straight & Right Angle Plugs - For Flexible Cable

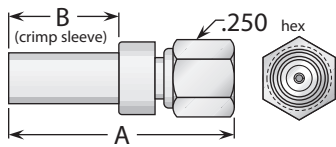

Figure 1
(Crimp type)

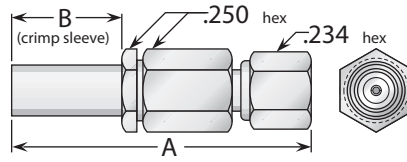

Figure 2
(Crimp type)

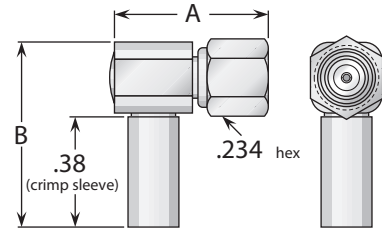

Figure 3
(Crimp type)

Cable Group	Figure	Dimensions		Plating		Delta P/N	Assembly Procedure/ Trim Code
		A	B	Body	Contact		
9	1	.800	.380	Gold	Gold	2503037G000-000	B/28
9	1	.800	.380	Nickel	Gold	2503037N000-000	B/28
9	2	1.03	.380	Gold	Gold (C)	2502045G001-001	***
9	2	1.03	.380	Nickel	Gold (C)	2502045N001-001	***
9	3	.560	.630	Gold	Gold (C)	2507037G001-000	B/29
9	3	.560	.630	Nickel	Gold (C)	2507037N001-000	B/29
10	1	.800	.380	Gold	Gold	2503100G000-000	B/28
10	1	.800	.380	Nickel	Gold	2503100N000-000	B/28
10	2	1.03	.380	Gold	Gold (C)	2502100G000-001	***
10	2	1.03	.380	Nickel	Gold (C)	2502100N000-001	***
10	3	.560	.630	Gold	Gold (C)	2507100G001-000	B/29
10	3	.560	.630	Nickel	Gold (C)	2507100N001-000	B/29
11	1	.800	.380	Gold	Gold	2503038G000-000	B/28
11	1	.800	.380	Nickel	Gold	2503038N000-000	B/28
11	2	1.03	.380	Gold	Gold (C)	2502038G001-001	***
11	2	1.03	.380	Nickel	Gold (C)	2502038N001-001	***
11	3	.560	.630	Gold	Gold (C)	2507038G001-000	B/29
11	3	.560	.630	Nickel	Gold (C)	2507038N001-000	B/29

Bulkhead Jack - For Flexible Cable

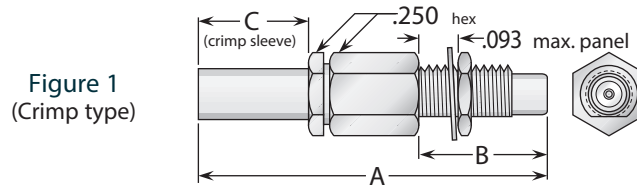

Figure 1
(Crimp type)

Cable Group	Fig.	Dimensions			Mounting Figure	Plating		Delta P/N	Assembly Procedure/ Trim Code
		A	B	C		Body	Contact		
9	1	1.17	.426	.380	68	Gold	Gold (C)	2519037G681-000	***
9	1	1.17	.426	.380	68	Nickel	Gold (C)	2519037N681-000	***
10	1	1.17	.426	.380	68	Gold	Gold (C)	2519100G681-000	***
10	1	1.17	.426	.380	68	Nickel	Gold (C)	2519100N681-000	***
11	1	1.17	.426	.380	68	Gold	Gold (C)	2519038G681-000	***
11	1	1.17	.426	.380	68	Nickel	Gold (C)	2519038N681-000	***

- See page 209 for cable groups.
- Assembly procedures start on page 210.
- ***Contact factory for cable assembly instructions.
- See page 208 for mounting dimensions.
- (C) in contact plating column indicates captive contact.

Bulkhead Jack Receptacles

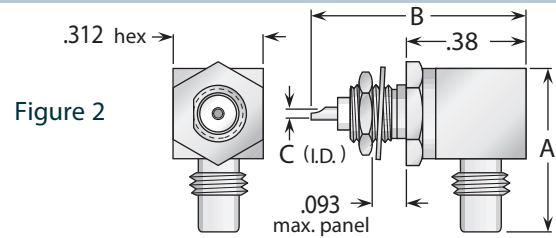
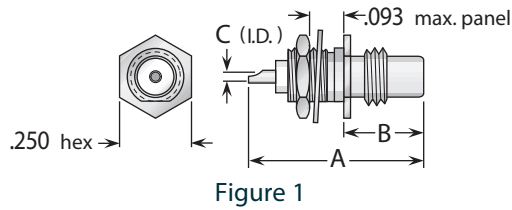

Figure	Dimensions			Mounting Figure	Plating		Delta P/N
	A	B	C		Body	Contact	
1	.590	.265	.035	68	Gold	Gold (C)	2520000G681-000
1	.590	.265	.035	68	Nickel	Gold (C)	2520000N681-000
2	.590	.750	.022	68	Gold	Gold (C)	2522000G681-000
2	.590	.750	.022	68	Nickel	Gold (C)	2522000N681-000

Panel Jack Receptacles

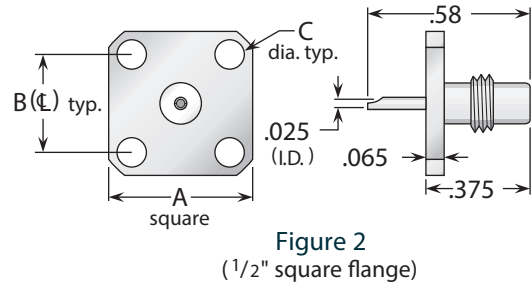
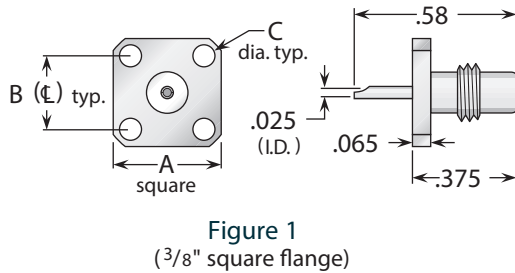

Figure	Dimensions			Mounting Figure	Plating		Delta P/N
	A	B	C		Body	Contact	
1	.375	.232	.093	91A	Gold	Gold (C)	2513000G911-000
1	.375	.232	.093	91A	Nickel	Gold (C)	2513000N911-000
2	.500	.340	.102	05	Gold	Gold (C)	2513000G051-000
2	.500	.340	.102	05	Nickel	Gold (C)	2513000N051-000

Printed-Circuit Board Receptacles

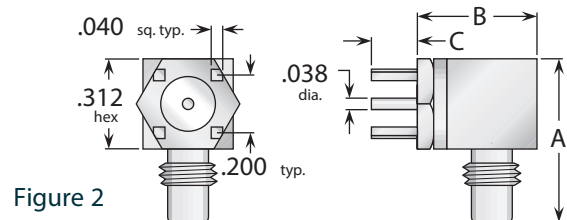
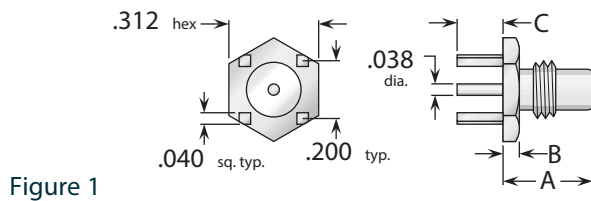

Figure	Dimensions			Max. Board	Mounting Figure	Plating		Delta P/N
	A	B	C			Body	Contact	
1	.300	.060	.155	.100	PCB06	Gold	Gold (C)	2568000G001-000
1	.300	.060	.155	.100	PCB06	Nickel	Gold (C)	2568000N001-000
2	.590	.375	.155	.100	PCB06	Gold	Gold (C)	2570000G00E-000
2	.590	.375	.155	.100	PCB06	Nickel	Gold (C)	2570000N00E-000

See page 208 for mounting dimensions. • (C) in contact plating column indicates captive contact.

General Description

Delta TNC connectors are compact, 50Ω impedance connectors with 7/16-28 threaded coupling, similar in size to BNC connectors but with better electrical characteristics. They are best suited for use with cables in the range of .150" to .250" diameter, but are available for other cables from .090" to over .75" diameter. Many of our TNC connectors are available as MIL-PRF-39012 QPL versions. These types are listed starting on page 198. Our extensive line of TNC receptacles includes configurations for virtually any packaging requirement, and we can supply any adapter or accessory you need to complete your system design. Adapters between TNC and other series are shown starting on page 176.

As with our other connector series, Delta's customer-driven design results in TNC series connectors with practical and unique features that make your design and assembly process easier. Some of these include:

- Heli-Grip cable connectors for fast, reliable assembly to flexible cable without special tooling.
- PressMount receptacles (page 147) mount securely in a single round hole, saving space on your components and reducing your housing fabrication costs.
- Panel receptacles with flange sizes to match the same hole pattern as standard SMA or type N connectors, letting you drill one hole pattern and mount BNC, N, SMA, TNC, or 7/16 series connectors as needed.
- TNC connectors with polarized interfaces (page 152) prevent mismatching and meet FCC Part 15.203 requirements.
- Keying baskets and keyed plugs (page 149) provide numerous polarizations in applications incorporating multiple connector pairs.

Our TNC series product line is still growing, so please call if you don't see what you need.

TNC Configurations

Straight Cable Plugs	137	Bulkhead Jack Receptacles	146
Right Angle Cable Plugs	139	PressMount Receptacles.....	147
Straight Cable Jacks	141	Stripline Receptacles	147
Bulkhead Cable Jacks	142	Resistive Terminations	148
Panel Cable Jacks	143	Dust Caps.....	148
Panel Jack Receptacles (square flange)	144	Keying Baskets.....	149
Right Angle Panel Jack Receptacles	145	In-Series Adapters	150
Panel Plug Receptacles.....	145	Polarized Plugs and Jacks	152

TNC Specifications*

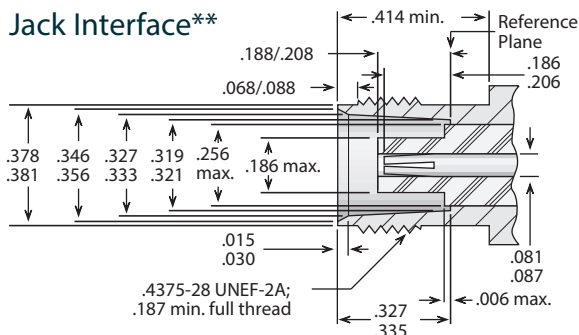
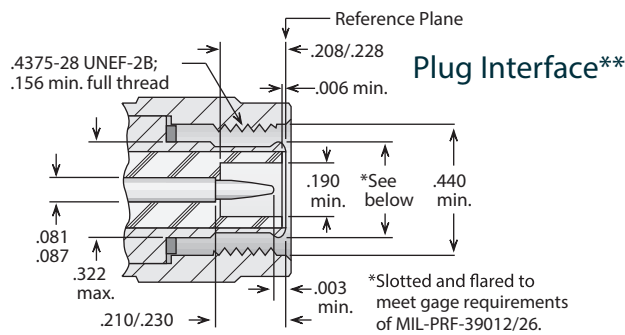

**Some proportions altered to illustrate detail.

Electrical:

Nominal Impedance: 50 ohms.
Frequency Range: DC-11 GHz.
Voltage Rating: 500 volts RMS.
Dielectric Withstanding Voltage : 1,500 VRMS.
Insulation Resistance: 5,000 megohms.

Materials/Finishes:

Insulators: Teflon per ASTM D1710.
Male Contacts: Brass per ASTM B16.
Female Contacts: Beryllium Copper per ASTM B196.
Contact Plating : Silver per ASTM B700, or Gold per MIL-DTL-45204.
Gaskets: Silicone rubber per ZZ-R-765, Class II, Grade 50.
Other Metal Parts: Brass per ASTM B16, plated: Silver per ASTM B700, or Nickel per AMS-QQ-N-290.

All other specifications are in accordance with the latest issues of MIL-PRF-39012, or MIL-A-55339, or other applicable MIL specifications, and interfaces are in accordance with MIL-STD-348.

*These specifications are typical and may not apply to all connectors. Detailed specifications for individual connectors are available on request.

Straight Plug - Military Clamp For Flexible Cable

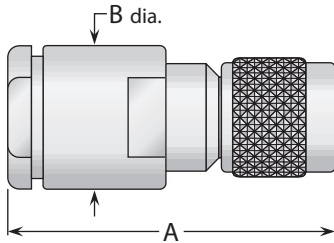

Figure 1
(Standard coupling nut)

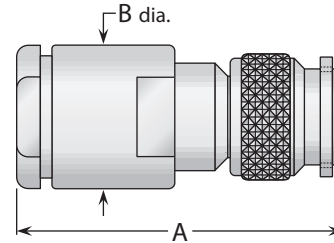

Figure 2
(Safety-wire holes in coupling nut)

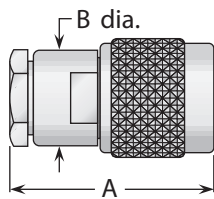

Figure 3
(Standard coupling nut)

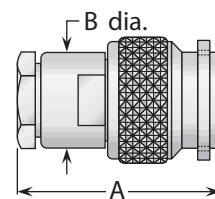
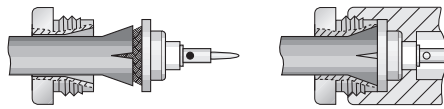

Figure 4
(Safety-wire holes in coupling nut)

Cable Group	Figure	Dimensions		Plating		Delta P/N	Assembly Procedure/ Trim Code
		A	B	Body	Contact		
1	1	1.66	.750	Nickel	Gold	1201001N000-000	A/01
2,3	1	1.66	.750	Nickel	Gold	1201004N000-000	A/01
2,3	1	1.66	.750	Nickel	Gold (C)	1201004N001-004	A/01
2,3	2	1.66	.750	Nickel	Gold	1240004N000-000	A/01
2,3	2	1.66	.750	Nickel	Gold (C)	1240004N001-000	A/01
5,6	3	1.09	.500	Nickel	Gold	1201015N000-000	A/17
5,6	3	1.09	.500	Nickel	Gold (C)	1201015N001-000	A/17
5,6	4	1.09	.500	Nickel	Gold	1240015N000-000	A/17
5,6	4	1.09	.500	Nickel	Gold (C)	1240015N001-000	A/17
7	3	1.09	.500	Nickel	Gold	1201021N000-000	A/17
7	3	1.09	.500	Nickel	Gold (C)	1201021N001-000	A/17
7	4	1.09	.500	Nickel	Gold	1240021N000-000	A/17
7	4	1.09	.500	Nickel	Gold (C)	1240021N001-000	A/17
8A	3	1.09	.500	Nickel	Gold	1201029N000-000	A/17
8A	3	1.09	.500	Nickel	Gold (C)	1201029N001-000	A/17
8B	3	1.09	.500	Nickel	Gold	1201043N000-000	A/17
8B	3	1.09	.500	Nickel	Gold (C)	1201043N001-000	A/17
9	3	1.09	.500	Nickel	Gold	1201036N000-000	A/18
9	3	1.09	.500	Nickel	Gold (C)	1201036N001-002	A/18
9	4	1.09	.500	Nickel	Gold	1240036N000-000	A/18
9	4	1.09	.500	Nickel	Gold (C)	1240036N001-000	A/18
11	3	1.09	.500	Nickel	Gold	1201038N000-000	A/18
11	3	1.09	.500	Nickel	Gold (C)	1201038N001-000	A/18

• See page 209 for cable groups. • Assembly procedures start on page 210.
 • (C) in contact plating column indicates captive contact. • See page 6 for alternate body plating information.

Straight Plug - Heli-Grip® For Flexible Cable



Heli-Grip® Cable Attachment

These connectors have captivated contacts and allow rapid, easy assembly—simply trim the cable, slide into the cone/insulator/contact assembly (left), solder the center conductor to the contact, and screw body assembly (right) onto the cable assembly.

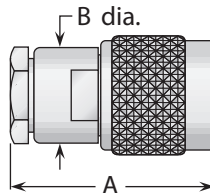

Figure 1

Cable Group	Figure	Dimensions		Plating		Delta P/N	Assembly Procedure/ Trim Code
		A	B	Body	Contact		
5, 6 [§]	1	1.09	.500	Nickel	Silver (C)	1201018N005-000	E/03
RG-223	1	1.09	.500	Nickel	Silver (C)	1201015N005-000	E/03
7	1	1.09	.500	Nickel	Silver (C)	1201019N005-000	E/03
8A	1	1.09	.500	Nickel	Silver (C)	1201029N005-000	E/03
8B	1	1.09	.500	Nickel	Silver (C)	1201043N005-000	E/03
9	1	1.09	.500	Nickel	Silver (C)	1201037N005-000	E/03
10	1	1.09	.500	Nickel	Silver (C)	1201100N005-000	E/03
11	1	1.09	.500	Nickel	Silver (C)	1201038N005-000	E/03

[§]Except RG-223/U.

Straight Plug - Crimp Type For Flexible Cable

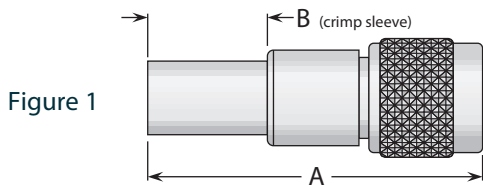

Figure 1

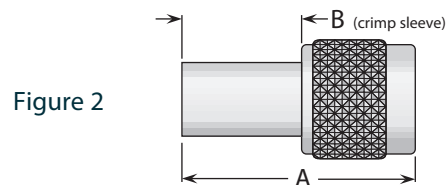

Figure 2

See page 198 for MIL-PRF-39012 QPL version.

Cable Group	Figure	Dimensions		Plating		Delta P/N	Assembly Procedure/ Trim Code
		A	B	Body	Contact		
3A, 4	1	1.75	.630	Nickel	Gold	1203005N000-000	B/11
5	2	1.06	.500	Nickel	Gold	1203017N000-000	B/23
6	2	1.06	.500	Nickel	Gold	1203013N000-000	B/23
7	2	1.06	.500	Nickel	Gold	1203020N000-000	B/23
7	2	1.04	.500	Nickel	Silver	1203020N000-003 *	***
7	2	1.04	.500	Nickel	Gold	1203020N000-005 *	***
7	2	1.06	.500	Nickel	Gold (C)	1203020N001-003 *	***

* Crimp center contact.

- See page 209 for cable groups.
- Assembly procedures start on page 210.
- (C) in contact plating column indicates captive contact.
- See page 6 for alternate body plating information.
- ***Contact factory for cable assembly instructions.

Straight Plug - Solder Clamp For Semi-Rigid Cable

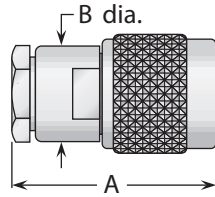

Figure 1
(Standard coupling nut)

See page 198 for
MIL-PRF-39012
QPL version.

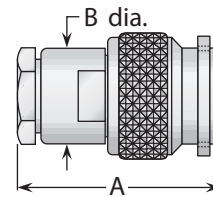

Figure 2
(Safety-wire holes in coupling nut)

Cable Group	Figure	Dimensions		Plating		Delta P/N	Assembly Procedure/ Trim Code
		A	B	Body	Contact		
13	1	1.09	.500	Nickel*	Gold	1201031N003-000	F/08
13	2	1.09	.500	Nickel*	Gold	1240031N003-000	F/08
14	1	1.09	.500	Nickel*	Gold	1201025N003-000	F/07
14	2	1.09	.500	Nickel*	Gold	1240025N003-000	F/07

* Solder ferrule is gold plated.

Right Angle Plug - Military Clamp For Flexible Cable

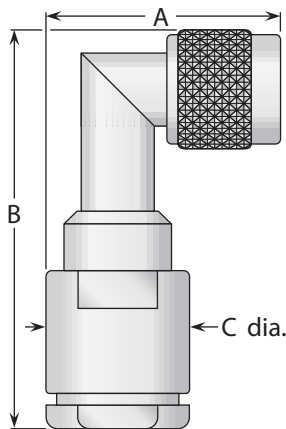

Figure 1

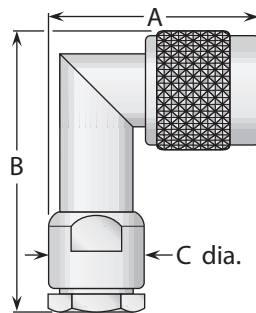

Figure 2

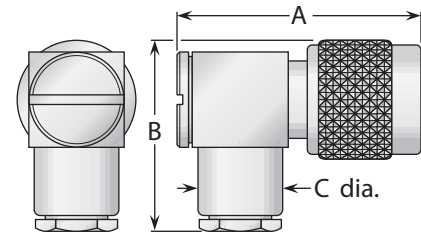
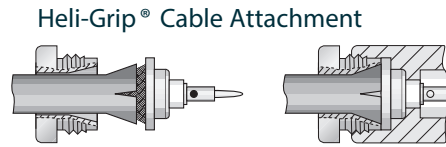
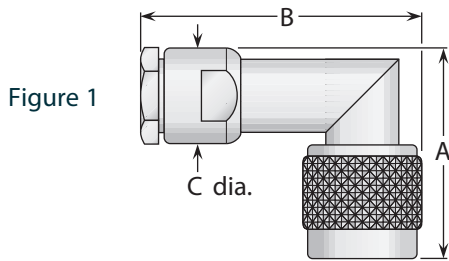

Figure 3

Cable Group	Figure	Dimensions			Plating		Delta P/N	Assembly Procedure/ Trim Code
		A	B	C	Body	Contact		
1	1	1.19	1.94	.750	Nickel	Gold	1204001N000-000	A/07
2, 3	1	1.19	1.94	.750	Nickel	Gold	1204004N000-000	A/07
2, 3	1	1.19	1.94	.750	Nickel	Gold (C)	1204004N001-000	A/07
5, 6	2	1.06	1.65	.500	Nickel	Gold	1204015N000-000	A/17
5, 6	2	1.06	1.65	.500	Nickel	Gold (C)	1204015N001-000	A/17
5, 6	3	1.20	1.11	.500	Nickel	Gold (C)	1205018N000-000	A/19
7	2	1.06	1.65	.500	Nickel	Gold	1204021N000-000	A/17
7	2	1.06	1.65	.500	Nickel	Gold (C)	1204021N001-000	A/17
7	3	1.20	1.11	.500	Nickel	Gold (C)	1205021N000-000	A/19
8A	3	1.20	1.11	.500	Nickel	Gold (C)	1205029N000-000	A/19
9	2	1.06	1.65	.500	Nickel	Gold	1204036N000-000	A/18
9	3	1.20	1.11	.500	Nickel	Gold (C)	1205036N000-001	A/19

- See page 209 for cable groups.
- Assembly procedures start on page 210.
- (C) in contact plating column indicates captive contact.
- See page 6 for alternate body plating information.

Right Angle Plug - Heli-Grip® For Flexible Cable



These connectors have captivated contacts and allow rapid, easy assembly—simply trim the cable, slide into the cone/insulator/contact assembly (left), solder the center conductor to the contact, and screw body assembly (right) onto cable assembly.

Cable Group	Figure	Dimensions			Plating		Delta P/N	Assembly Procedure/ Trim Code
		A	B	C	Body	Contact		
5, 6 [§]	1	1.06	1.65	.500	Nickel	Silver (C)	1204018N005-000	E/03
RG-223	1	1.06	1.65	.500	Nickel	Silver (C)	1204015N005-000	E/03
7	1	1.06	1.65	.500	Nickel	Silver (C)	1204019N005-000	E/03
8A	1	1.06	1.65	.500	Nickel	Silver (C)	1204029N005-000	E/03
8B	1	1.06	1.65	.500	Nickel	Silver (C)	1204043N005-000	E/03
9	1	1.06	1.65	.500	Nickel	Silver (C)	1204037N005-000	E/03
10	1	1.06	1.65	.500	Nickel	Silver (C)	1204100N005-000	E/03
11	1	1.06	1.65	.500	Nickel	Silver (C)	1204038N005-000	E/03

[§]Except RG-223/U.

Right Angle Plug - Crimp Type For Flexible Cable

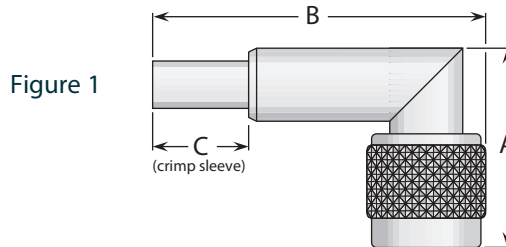

Cable Group	Figure	Dimensions			Plating		Delta P/N	Assembly Procedure/ Trim Code
		A	B	C	Body	Contact		
5	1	1.03	1.72	.500	Nickel	Gold	1207017N000-000	B/02
6	1	1.03	1.72	.500	Nickel	Gold	1207015N000-000	B/02
7	1	1.03	1.72	.500	Nickel	Gold	1207020N000-000	B/02

Right Angle Plug - Solder-Clamp For Semi-Rigid Cable

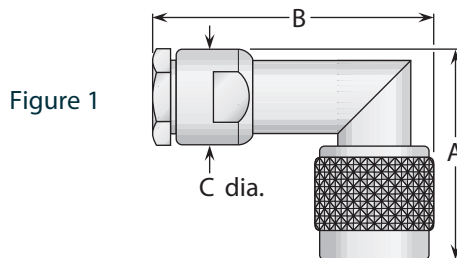

* Solder ferrule is gold plated.

Cable Group	Figure	Dimensions			Plating		Delta P/N	Assembly Procedure/ Trim Code
		A	B	C	Body	Contact		
13	1	1.06	1.65	.500	Nickel*	Gold	1204031N003-000	F/08
14	1	1.06	1.65	.500	Nickel*	Gold	1204025N003-000	F/07

* Solder Ferrule Is Gold Plated

- See page 209 for cable groups.
- Assembly procedures start on page 210.
- (C) in contact plating column indicates captive contact.
- See page 6 for alternate body plating information.

Straight Jacks - For Flexible & Semi-Rigid Cable

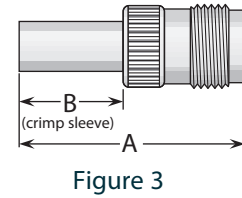
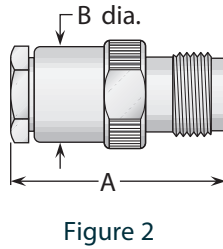
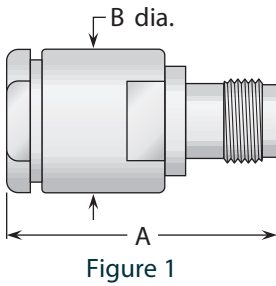

See page 199 for MIL-PRF-39012 QPL versions.

Heli-Grip® Cable Attachment (where noted)

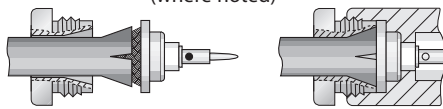

These connectors have captivated contacts and allow rapid, easy assembly—simply trim the cable, slide into the cone/insulator/contact assembly (left), solder the center conductor to the contact, and screw body assembly (right) onto the cable assembly.

Military Clamp for Flexible Cable							
Cable Group	Figure	Dimensions		Plating		Delta P/N	Assembly Procedure/ Trim Code
		A	B	Body	Contact		
1	1	1.75	.750	Nickel	Gold	1208001N000-000	A/20
2, 3	1	1.75	.750	Nickel	Gold	1208004N000-000	A/20
5, 6	2	1.16	.500	Nickel	Gold	1208015N000-000	A/17
5, 6	2	1.16	.500	Nickel	Gold (C)	1208015N001-000	A/17
7	2	1.16	.500	Nickel	Gold	1208021N000-000	A/17
7	2	1.16	.500	Nickel	Gold (C)	1208021N001-000	A/17
9	2	1.16	.500	Nickel	Gold	1208036N000-000	A/18
9	2	1.16	.500	Nickel	Gold (C)	1208036N001-000	A/18
11	2	1.16	.500	Nickel	Gold	1208038N000-000	A/18
Heli-Grip for Flexible Cable							
5, 6 [§]	2	1.16	.500	Nickel	Silver (C)	1208018N005-001	E/03
RG-223	2	1.16	.500	Nickel	Silver (C)	1208015N005-000	E/03
7	2	1.16	.500	Nickel	Silver (C)	1208019N005-000	E/03
8A	2	1.16	.500	Nickel	Silver (C)	1208029N005-000	E/03
8B	2	1.16	.500	Nickel	Silver (C)	1208043N005-000	E/03
9	2	1.16	.500	Nickel	Silver (C)	1208037N005-000	E/03
10	2	1.16	.500	Nickel	Silver (C)	1208100N005-000	E/03
11	2	1.16	.500	Nickel	Silver (C)	1208038N005-000	E/03
Crimp Type for Flexible Cable							
5	3	1.16	.500	Nickel	Gold	1210017N000-000	B/05
6	3	1.16	.500	Nickel	Gold	1210013N000-000	B/05
7	3	1.16	.500	Nickel	Gold	1210020N000-000	B/05
7	3	1.06	.410	Nickel	Silver	1210020N001-000**	***
Solder-Clamp for Semi-Rigid Cable							
13	2	1.16	.500	Nickel*	Gold	1208031N003-000	F/08
14	2	1.16	.500	Nickel*	Gold	1208025N003-000	F/07

[§]Except RG-223/U.

*Solder ferrule is gold plated.

- See page 209 for cable groups.
- Assembly procedures start on page 210.
- (C) in contact plating column indicates captive contact.
- See page 6 for alternate body plating information.
- **Indicates crimp center contact.
- ***Contact factory for cable assembly instructions.

Bulkhead Jacks - For Flexible & Semi-Rigid Cable

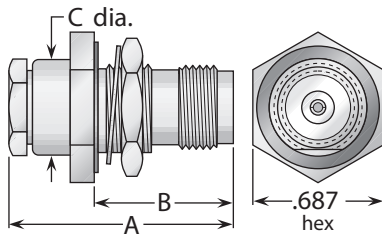

Figure 1
(Rear mount)

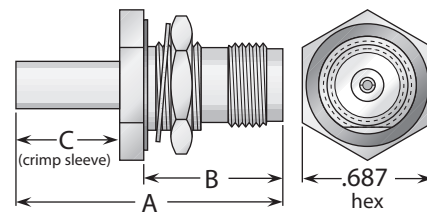
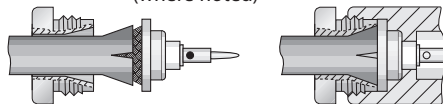

Figure 2
(Rear mount)

See page 199 for MIL-PRF-39012 QPL versions.

Heli-Grip® Cable Attachment (where noted)



These connectors have captivated contacts and allow rapid, easy assembly—simply trim the cable, slide into the cone/insulator/contact assembly (left), solder the center conductor to the contact, and screw body assembly (right) onto the cable assembly.

Military Clamp for Flexible Cable

Cable Group	Fig.	Dimensions			Mounting Figure	Max. Panel	Plating		Delta P/N	Assembly Procedure/Trim Code
		A	B	C			Body	Contact		
5, 6	1	1.16	.680	.500	59	.110	Nickel	Gold	1216015N590-000	A/17
5, 6	1	1.16	.680	.500	59	.110	Nickel	Gold (C)	1216015N591-000	A/17
5, 6	1	1.16	.810	.500	59	.240	Nickel	Gold (C)	1216015N59E-000	A/17
7	1	1.16	.680	.500	59	.110	Nickel	Gold	1216021N590-002	A/17
7	1	1.16	.680	.500	59	.110	Nickel	Gold (C)	1216021N591-000	A/17
7	1	1.16	.810	.500	59	.240	Nickel	Gold (C)	1216021N59E-000	A/17
9	1	1.16	.680	.500	59	.110	Nickel	Gold	1216036N590-000	A/17
9	1	1.16	.680	.500	59	.110	Nickel	Gold (C)	1216036N591-005	A/18
11	1	1.16	.680	.500	59	.110	Nickel	Gold	1216038N590-002	A/18
11	1	1.16	.680	.500	59	.110	Nickel	Gold (C)	1216038N591-001	A/18

Heli-Grip for Flexible Cable

5, 6 [§]	1	1.16	.810	.500	59	.240	Nickel	Silver (C)	1216018N595-000	E/03
RG-223	1	1.16	.810	.500	59	.240	Nickel	Silver (C)	1216015N595-001	E/03
7	1	1.16	.810	.500	59	.240	Nickel	Silver (C)	1216019N595-000	E/03
8A	1	1.16	.810	.500	59	.240	Nickel	Silver (C)	1216029N595-000	E/03
8B	1	1.16	.810	.500	59	.240	Nickel	Silver (C)	1216043N595-000	E/03
9	1	1.16	.810	.500	59	.240	Nickel	Silver (C)	1216037N595-000	E/03
10	1	1.16	.810	.500	59	.240	Nickel	Silver (C)	1216100N595-002	E/03
11	1	1.16	.810	.500	59	.240	Nickel	Silver (C)	1216038N595-000	E/03

Crimp Type for Flexible Cable

5	2	1.31	.680	.500	59	.110	Nickel	Gold	1219017N590-000	B/13
6	2	1.31	.680	.500	59	.110	Nickel	Gold	1219013N590-002	B/13
7	2	1.31	.680	.500	59	.110	Nickel	Gold	1219020N590-000	B/13

Solder-Clamp for Semi-Rigid Cable

13	1	1.16	.680	.500	59	.110	Nickel*	Gold	1216031N593-000	F/08
14	1	1.16	.680	.500	59	.110	Nickel*	Gold	1216025N593-000	F/07

[§]Except RG-223/U.

* Solder ferrule is gold plated.

- See page 209 for cable groups.
- Assembly procedures start on page 210.
- See page 208 for mounting dimensions.
- (C) in contact plating column indicates captive contact.
- See page 6 for alternate body plating information.

Bulkhead Jacks - For Flexible & Semi-Rigid Cable

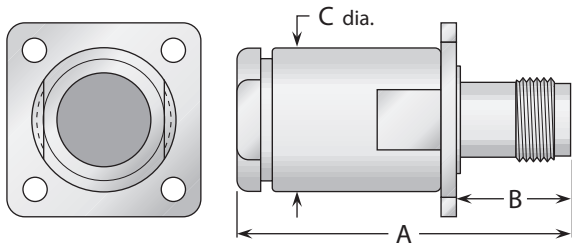

Figure 1

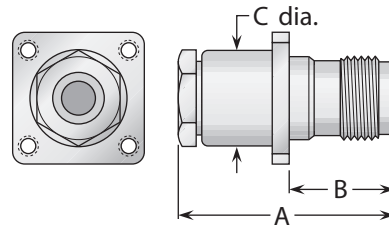
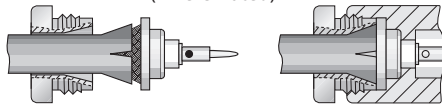

Figure 2

See page 200 for MIL-PRF-39012 QPL version.

Heli-Grip® Cable Attachment (where noted)



These connectors have captivated contacts and allow rapid, easy assembly—simply trim the cable, slide into the cone/insulator/contact assembly (left), solder the center conductor to the contact, and screw body assembly (right) onto the cable assembly.

Cable Group	Fig.	Dimensions			Mounting Figure	Plating		Delta P/N	Assembly Procedure/Trim Code
		A	B	C		Body	Contact		
Military Clamp for Flexible Cable									
1	1	1.75	.630	.750	33	Nickel	Gold	1211001N330-000	A/20
2, 3	1	1.75	.630	.750	33	Nickel	Gold	1211004N330-000	A/20
5, 6	2	1.16	.550	.500	07	Nickel	Gold	1211015N070-000	A/17
5, 6	2	1.16	.550	.500	07	Nickel	Gold (C)	1211015N071-000	A/17
7	2	1.16	.550	.500	07	Nickel	Gold	1211021N070-000	A/17
7	2	1.16	.550	.500	07	Nickel	Gold (C)	1211021N071-000	A/17
9	2	1.16	.550	.500	07	Nickel	Gold	1211036N070-000	A/18
9	2	1.16	.550	.500	07	Nickel	Gold (C)	1211036N071-000	A/18
11	2	1.16	.550	.500	07	Nickel	Gold	1211038N070-000	A/18
Heli-Grip for Flexible Cable									
5, 6 [§]	1	1.16	.550	.500	07	Nickel	Silver (C)	1211018N075-001	E/03
RG-223	1	1.16	.550	.500	07	Nickel	Silver (C)	1211015N075-000	E/03
7	1	1.16	.550	.500	07	Nickel	Silver (C)	1211019N075-000	E/03
8A	1	1.16	.550	.500	07	Nickel	Silver (C)	1211029N075-000	E/03
8B	1	1.16	.550	.500	07	Nickel	Silver (C)	1211043N075-000	E/03
9	1	1.16	.550	.500	07	Nickel	Silver (C)	1211037N075-000	E/03
10	1	1.16	.550	.500	07	Nickel	Silver (C)	1211100N075-000	E/03
11	1	1.16	.550	.500	07	Nickel	Silver (C)	1211038N075-000	E/03
Solder-Clamp for Semi-Rigid Cable									
13	1	1.16	.550	.500	07	Nickel*	Gold	1211031N073-000	F/08
14	1	1.16	.550	.500	07	Nickel*	Gold	1211025N073-000	F/07

[§]Except RG-223/U.

* Solder ferrule is gold plated.

- See page 209 for cable groups.
- Assembly procedures start on page 210.
- See page 208 for mounting dimensions.
- (C) in contact plating column indicates captive contact.
- See page 6 for alternate body plating information.

Panel Jack Receptacles - Square Flange

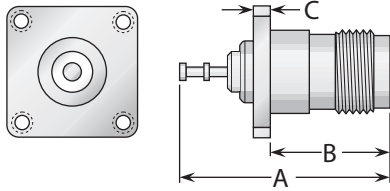

Figure 1
(Turret contact)

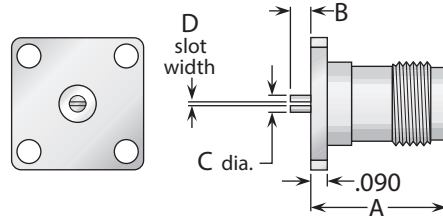

Figure 2
(Slotted contact)

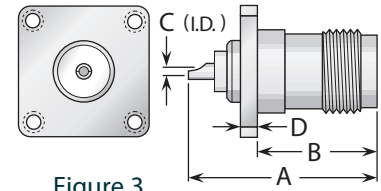

Figure 3
(Solder pot contact)

See page 201 for
MIL-PRF-39012 QPL version.

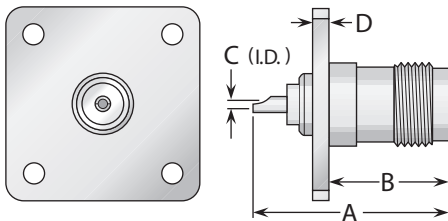

Figure 4
(Solder pot contact, 1" square flange,
interchangeable with type N standard flange size)

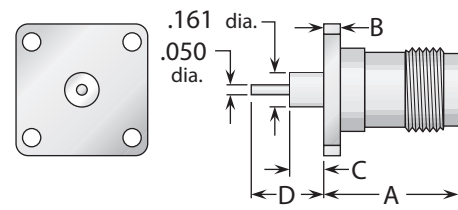

Figure 5
(Post contact)

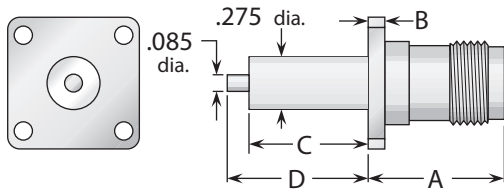

Figure 6
(Post contact)

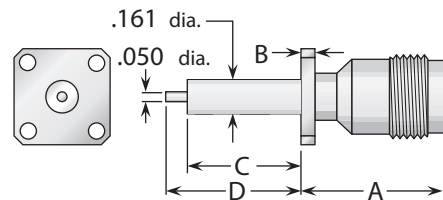

Figure 7
(Post contact, 1/2" square flange,
interchangeable with SMA standard flange size)

Figure	Dimensions				Mounting Figure	Plating		Delta P/N
	A	B	C	D		Body	Contact	
1	1.06	.630	.090	—	07	Nickel	Silver (C)	1212000N070-000
2	.715	.050	.085	.012/.017	09	Nickel	Gold (C)*	1243000F09E-001
2	.715	.050	.085	.036/.040	09	Nickel	Gold (C)*	1243000F09E-002
3	1.06	.630	.062	.090	07	Nickel	Gold (C)	1213000N071-000
3	1.06	.630	.062	.090	08	Nickel	Gold (C)	1213000N080-000
3	1.06	.630	.062	.090	09	Nickel	Gold (C)	1213000N090-000
3	1.06	.630	.062	.090	18	Nickel	Gold (C)	1213000N180-000
4	1.06	.630	.062	.080	33	Nickel	Gold (C)	1213000N330-000
5	.715	.090	.175	.375	09	Nickel	Gold (C)	1258000N091-009
6	.750	.080	.000	1.25	18	Nickel	Gold (C)	1258000N181-000
6	.750	.080	.590	.705	18 ^s	Nickel	Gold (C)*	1258000N181-009
7	.750	.080	.590	.705	05	Nickel	Gold (C)	1258000N051-000

- (C) in contact plating column indicates captive contact. • *Indicates epoxy-captivated contact.
- ^sFlange #18 except with .125 dia. mounting holes. • See page 6 for alternate body plating information.
- See page 208 for mounting dimensions. • All items are available with other flange sizes and contact configurations.

Right Angle & Panel Jack Receptacles - Square Flange

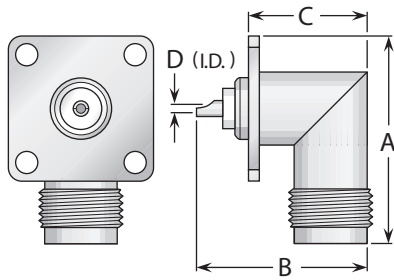

Figure 1
(Solder pot contact)

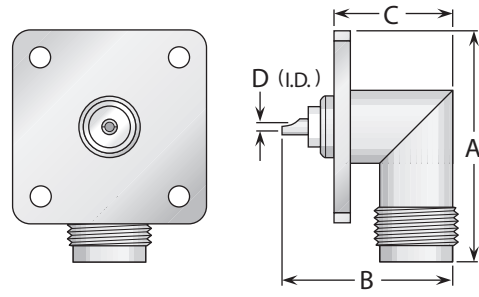

Figure 2
(Solder pot contact, 1" square flange, interchangeable with type N standard flange size)

Figure	Dimensions				Mounting Figure	Plating		Delta P/N
	A	B	C	D		Body	Contact	
1	1.06	.910	.650	.062	07	Nickel	Gold (C)	1215000N070-000
1	1.06	.910	.650	.062	08	Nickel	Gold (C)	1215000N080-000
1	1.09	.910	.610	.062	18	Nickel	Gold (C)	1215000N180-000
2	1.22	.910	.650	.062	33	Nickel	Gold (C)	1215000N330-000

Panel Plug Receptacles - Square Flange

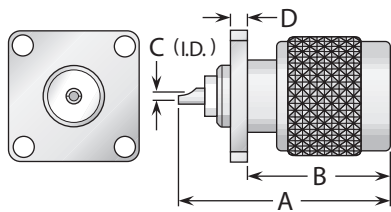

Figure 1
(Solder pot contact, 3/4" square flange)

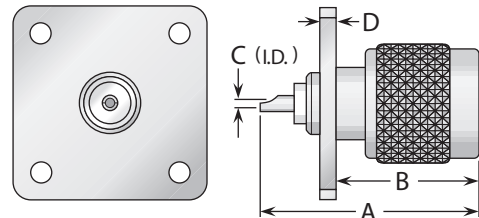

Figure 2
(Solder pot contact, 1" square flange, interchangeable with type N standard flange size)

Figure 3
(Slotted contact, 11/16" square flange)

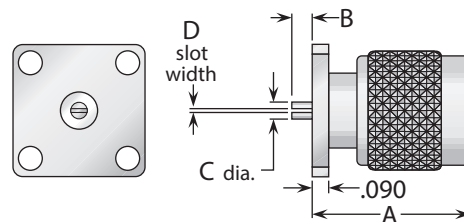

Figure	Dimensions				Mounting Figure	Plating		Delta P/N
	A	B	C	D		Body	Contact	
1	1.16	.740	.062	.090	18	Nickel	Gold (C)	1223000N180-000
2	1.16	.740	.062	.080	33	Nickel	Gold (C)	1223000N330-000
3	.830	.050	.083	.012/.017	09	Nickel	Gold (C)	1259000N091-001
3	.830	.050	.083	.030	09	Nickel	Gold (C)	1259000N091-002
3	.830	.050	.083	.040	09	Nickel	Gold (C)	1259000N091-003

- (C) in contact plating column indicates captive contact.
- See page 6 for alternate body plating information.
- See page 208 for mounting dimensions.
- All items are available with other flange sizes and contact configurations.

Bulkhead Jack Receptacles

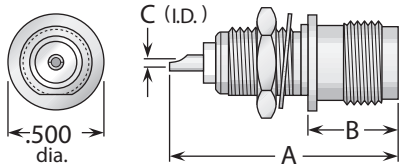

Figure 1
(Front mount)

See page 200 for MIL-PRF-39012 QPL version.

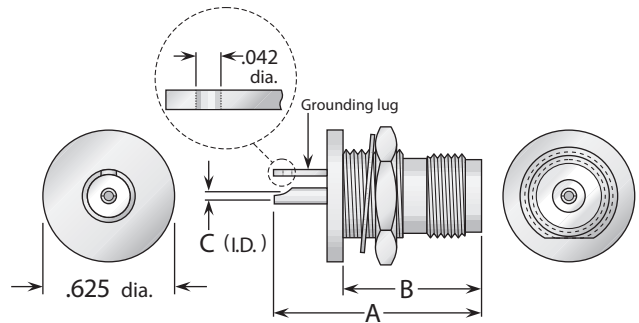

Figure 2
(Rear mount, with grounding lug)

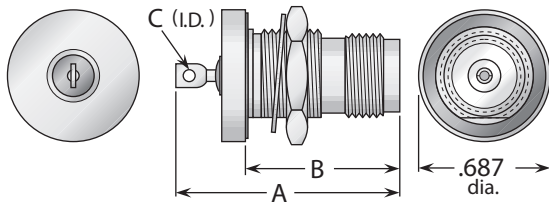

Figure 3
(Rear mount, hermetically sealed,
with mounting gasket)

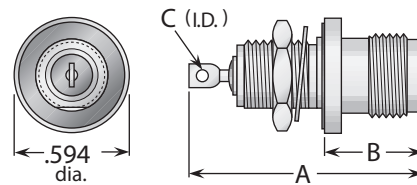

Figure 4
(Front mount, hermetically sealed,
with mounting gasket)

Figure 5
(Right angle, with mounting gasket)

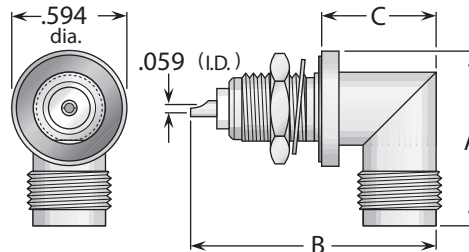
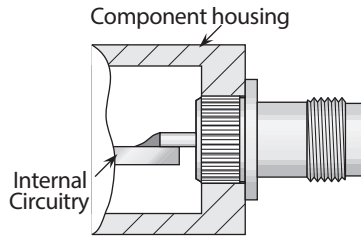

Figure	Dimensions			Max. Panel	Mounting Figure	Plating		Delta P/N
	A	B	C			Body	Contact	
1	1.06	.470	.062	.130	62	Nickel	Gold (C)	1220000N620-000
1	1.19	.470	.062	.260	62	Nickel	Gold (C)	1220000N62E-001
1	1.06	.470	.062	.130	65	Nickel	Gold (C)	1220000N650-000
1	1.06	.470	.062	.190	65	Nickel	Silver (C)	1220000N656-000
1	1.06	.470	.062	.190	65	Nickel	Gold (C)	1220000N65E-000
1	1.19	.470	.062	.260	65	Nickel	Gold (C)	1220000N65G-000
2	1.06	.750	.062	.160	59	Nickel	Gold (C)	1221000N591-003
3	1.20	.830	.062	.260	59	Nickel	Gold (C)	1221000N598-000
4	1.20	.520	.062	.260	65	Nickel	Gold (C)	1220000N638-000
5	.970	1.22	.590	.130	65	Nickel	Gold (C)	1222000N630-001
5	.970	1.34	.590	.250	65	Nickel	Gold (C)	1222000N630-002

(C) in contact plating column indicates captive contact. • See page 208 for mounting dimensions.
See page 6 for alternate body plating information. • All items are available with other flange sizes and contact configurations.

Press Mount Receptacles



Delta Press Mount Receptacles

These connectors eliminate the need for complicated mounting hole patterns and mounting hardware.

They are simply pressed into a single through hole, and the precisely-engineered knurled mounting section provides retention strength far greater than normal mating and unmating forces. An integral shoulder provides a positive stop when mounting.

PressMounts are available for a wide variety of Delta connector series, and can be used in packages as small as the outer diameter of the connector body.

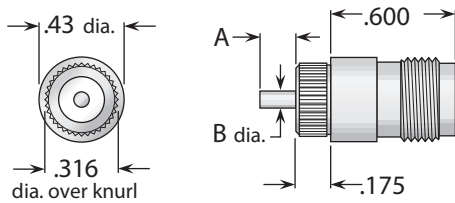

Figure 1
(Post contact)

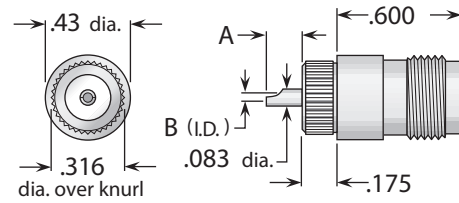

Figure 2
(Solder pot contact)

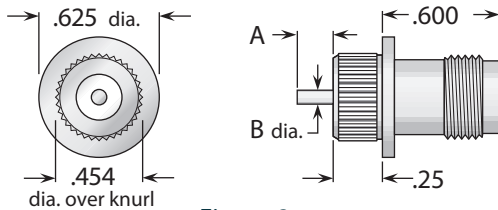

Figure 3
(Post contact)

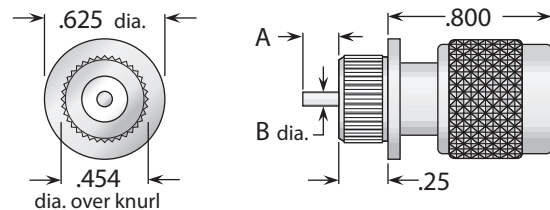

Figure 4
(Plug type, post contact)

Figure	Dimensions		Min. Panel	Mounting Hole	Plating		Delta P/N
	A	B			Body	Contact	
1	.062	.050	.150	.312 ±.001 dia.	Nickel	Gold (C)	1220000N911-002
2	.285	.062	.150	.312 ±.001 dia.	Nickel	Gold (C)	1220000N911-003
3	.060	.050	.200	.450 ±.001 dia.	Nickel	Gold (C)	1220000N911-005
4	.060	.050	.200	.450 ±.001 dia.	Nickel	Gold (C)	1224000N911-002

Stripline Receptacles

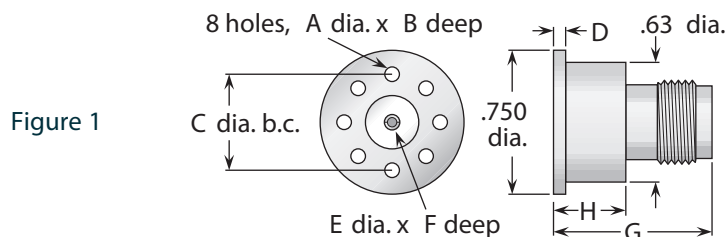

Figure 1

Figure	Dimensions								Plating		Delta P/N
	A	B	C	D	E	F	G	H	Body	Contact	
1	.078	.310	.500	.063	.063	.220	.828	.375	Nickel	Gold (C)	1256000N000-002
1	#2-56	.250	.500	.063	.063	.220	.828	.375	Nickel	Gold (C)	1256000N000-003

- (C) in contact plating column indicates captive contact.
- See page 6 for alternate body plating information.
- All items are available with other flange sizes and contact configurations.

Resistive Termination (Plug Type)

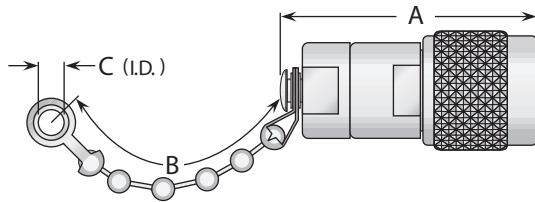

Figure 1

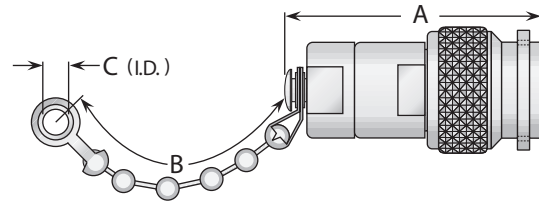

Figure 2

(Safety-wire holes in coupling nut)

Resistor	Fig.	Dimensions			Features	Plating		Delta P/N
		A	B	C		Body	Contact	
51 Ω ±5%, 1/2 Watt	1	1.25	3.50	.144	Bead chain	Nickel	Gold (C)	1231000N000-000
51 Ω ±5%, 1/2 Watt	1	1.25	—	—	No chain	Nickel	Gold (C)	1231000N00A-000
75 Ω ±1%, 1/2 Watt	2	1.25	3.50	.144	Bead chain	Nickel	Gold (C)	1231000N000-005
75 Ω ±1%, 1/2 Watt	1	1.25	—	—	No chain	Nickel	Gold (C)	1231000N00A-002

Dust Caps

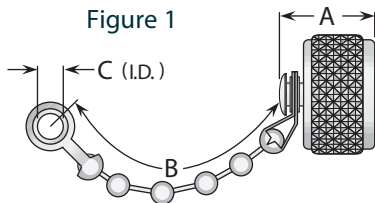

Figure 1

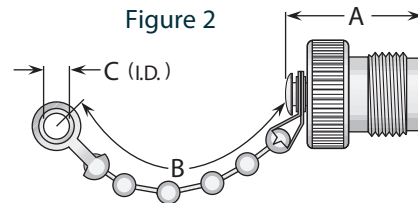
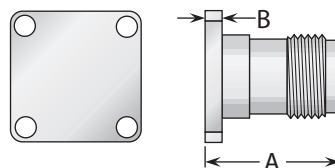

Figure 2

Figure	Dimensions			Features	Plating		Delta P/N
	A	B	C		Body	Contact	
1	.530	2.25	.144	Bead chain	Nickel	—	1232000N000-000
1	.370	—	—	No chain	Nickel	—	1232000N00A-000
1	.690	2.25	.144	Bead chain / shorting type	Nickel	Gold (C)	1232000N00C-000
2	.580	3.50	.144	Bead chain	Nickel	—	1233000N000-002
2	.580	—	—	No chain	Nickel	—	1233000N00A-000
2	.690	2.50	.144	Bead chain / shorting type	Nickel	Gold (C)	1233000N00C-000

Dummy Receptacle



Dimensions		Mounting Figure	Plating		Delta P/N
A	B		Body	Contact	
.715	.080	09	Nickel	—	1263000N090-000

- (C) in contact plating column indicates captive contact.
- See page 6 for alternate body plating information.
- See page 203 for mounting dimensions.
- Caps and terminations are available with other chain styles and/or resistances.

Keying Baskets - For Polarization Of Mated Pairs

Multiple Polarizations in a Single Installation

In applications with multiple connector pairs, these keying baskets polarize individual jacks so they can only be mated with plugs that have coupling nuts modified with the correct groove orientation.

The grooves in the plug coupling nuts engage the keying bars in the basket, making it impossible to mismate pairs, even by force.

The keying baskets can be used with any TNC jack—they slide over the jack's mating threads and are secured with a Truarc retaining ring. Any Delta TNC plug can be supplied with a grooved coupling nut to match any keying basket.

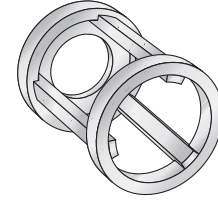

Application Example

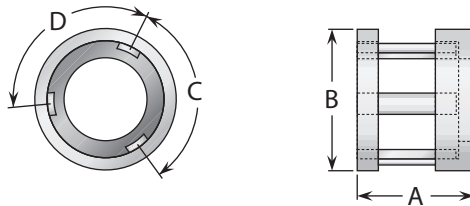
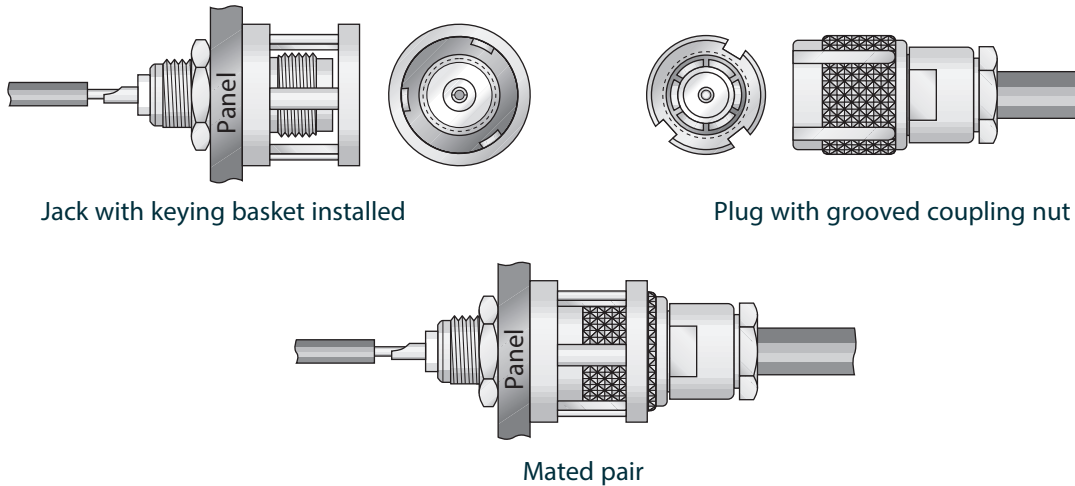

Figure 1

Figure	Dimensions				Plating	Delta P/N
	A	B	C	D		
1	.430	.730	72°	120°	Silver	1261000A00M-001
1	.430	.730	96°	96°	Silver	1261000A00M-002
1	.430	.730	120°	144°	Silver	1261000A00M-003
1	.430	.730	72°	144°	Silver	1261000A00M-004
1	.430	.730	120°	120°	Silver	1261000A00M-005
1	.430	.730	120°	72°	Silver	1261000A00M-006

See page 6 for alternate body plating information.

Bulkhead & Panel Mounted Jack-Jack Adapters (Connect Two Plugs)

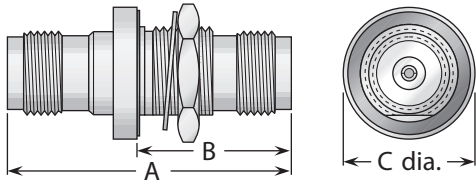

Figure 1
(Bulkhead mount)

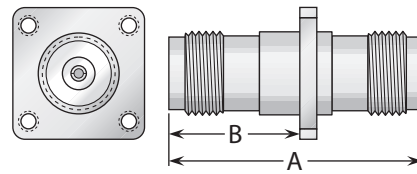

Figure 2
(Panel mount)

Figure	Dimensions			Max. Panel	Mounting Figure	Plating		Delta P/N
	A	B	C			Body	Contact	
1	1.28	.800	.625	.160	59	Nickel	Gold (C)	1226000N591-001
1	1.39	.760	.690	.190	59	Nickel	Gold (C)	1226000N598-002 *
2	1.28	.690	—	—	07	Nickel	Silver (C)	1225000N070-001

* Hermetically sealed, with mounting gasket.

Straight Adapters

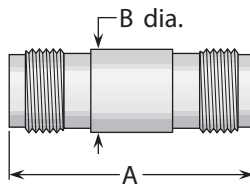

Figure 1
(Straight jack-jack;
connects two plugs)

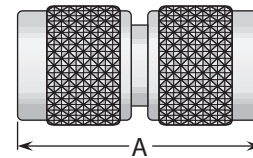

Figure 2
(Straight plug-plug;
connects two jacks)

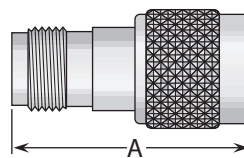

Figure 3
(Straight jack-plug;
connects one plug and one jack)

Figure	Dimensions		Plating		Delta P/N
	A	B	Body	Contact	
1	1.28	.440	Nickel	Silver (C)	1228000N000-000
2	1.25	—	Nickel	Gold (C)	1227000N000-000
3	1.22	—	Nickel	Gold (C)	1234000N000-000

(C) in contact plating column indicates captive contact. • See page 6 for alternate body plating information.
See page 208 for mounting dimensions.

Right Angle Adapters

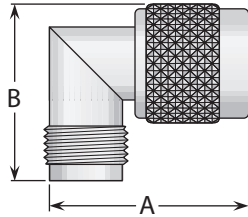

Figure 1
 (Right angle plug-jack;
 connects one plug and one jack)

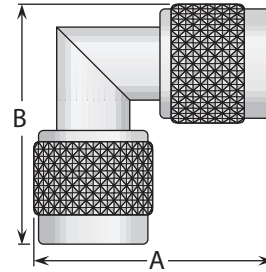

Figure 2
 (Right angle plug-plug;
 connects two jacks)

Figure	Dimensions		Plating		Delta P/N
	A	B	Body	Contact	
1	1.03	.950	Nickel	Gold (C)	1229000N000-000
2	1.25	1.25	Nickel	Gold (C)	1241000N000-000

Tee Adapters

Figure 1
 (Tee jack-jack-jack;
 connects three plugs)

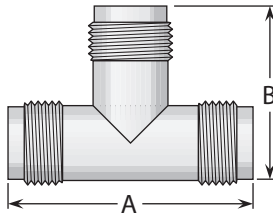

Figure 2
 (Tee jack-plug-jack;
 connects two plugs
 and one jack)

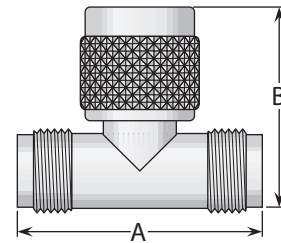

Figure 3
 (Tee plug-jack-plug;
 connects two jacks
 and one plug)

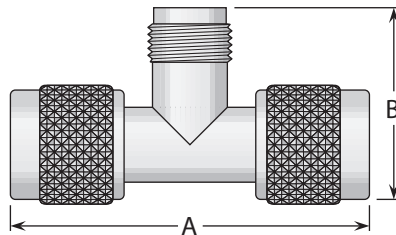

Figure 4
 (Tee jack-jack-plug;
 connects two plugs
 and one jack)

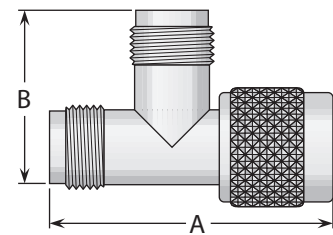

Figure	Dimensions		Plating		Delta P/N
	A	B	Body	Contact	
1	1.28	.880	Nickel	Gold (C)	1238000N000-000
2	1.28	1.03	Nickel	Gold (C)	1230000N000-000
3	1.88	.950	Nickel	Gold (C)	1242000N000-000
4	1.48	1.06	Nickel	Silver (C)	1249000N000-000

• (C) in contact plating column indicates captive contact.

• See page 6 for alternate body plating information.

Cable Plugs & Jacks

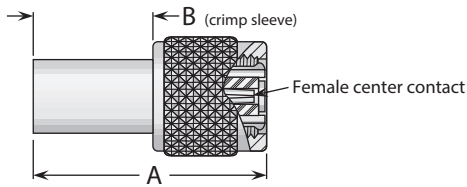

Figure 1
(Crimp type plug)

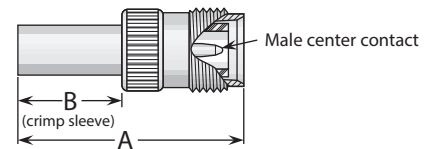

Figure 2
(Crimp type jack)

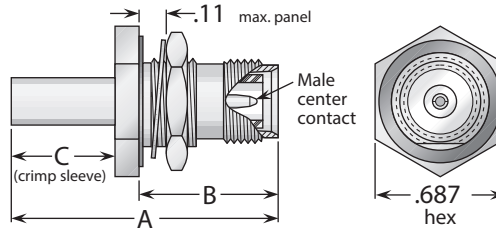

Figure 3
(Crimp type bulkhead jack)

Cable Group	Fig.	Dimensions			Mounting Figure	Plating		Delta P/N	Assembly Procedure/Trim Code
		A	B	C		Body	Contact		
5	1	1.06	.500	—	—	Nickel	Gold	1203017N002-000	B/23
5	2	1.16	.500	—	—	Nickel	Gold	1210017N002-000	B/05
5	3	1.31	.680	.500	59	Nickel	Gold	1219017N592-000	B/13
6	1	1.06	.500	—	—	Nickel	Gold	1203013N002-000	B/23
6	2	1.16	.500	—	—	Nickel	Gold	1210013N002-000	B/05
6	3	1.31	.680	.500	59	Nickel	Gold	1219013N592-000	B/13

Jack Receptacles

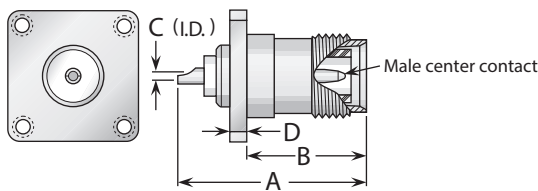

Figure 1
(Panel jack receptacle)

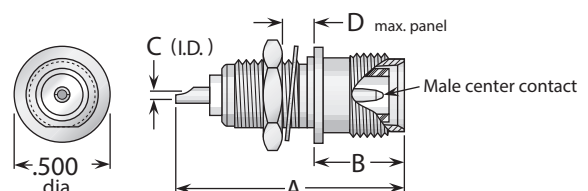

Figure 2
(Bulkhead jack receptacle)

Figure	Dimensions				Mounting Figure	Plating		Delta P/N
	A	B	C	D		Body	Contact	
1	1.06	.630	.062	.090	07	Nickel	Gold (C)	1213000N072-005
1	1.16	.630	.062	.090	09	Nickel	Gold (C)	1213000N092-000
2	1.06	.470	.062	.130	62	Nickel	Gold (C)	1220000N622-000
2	1.06	.470	.062	.190	65	Nickel	Gold (C)	1220000N652-001

- See page 209 for cable groups.
- Assembly procedures start on page 210.
- See page 208 for mounting dimensions.
- (C) in contact plating column indicates captive contact.
- See page 6 for alternate body plating information.

General Description

Delta TPS connectors are subminiature, 50 Ω impedance connectors with three-stud bayonet coupling. This interface design allows for quick mating and unmating, but prevents the mated pairs from rocking and improves electrical performance over that of BNC connectors. They are best suited for use with cables in the range of .100" to .250" diameter. Gold plating is standard for bodies in this series, but all Delta TPS connectors are available with nickel-plated bodies for reduced cost.

As with all other Delta connector series, we welcome your specifications for special configurations.

TPS Configurations

Straight Cable Plugs	154
Right Angle Cable Plugs	154
Straight Cable Jacks	154
Bulkhead Cable Jacks	154
Panel Jack Receptacles (square flange)	155
Bulkhead Jack Receptacles	155
Right Angle Bulkhead Jack Receptacles	155
Dummy Receptacles	155
In-Series Adapters	155

TPS Specifications*

Jack Interface**

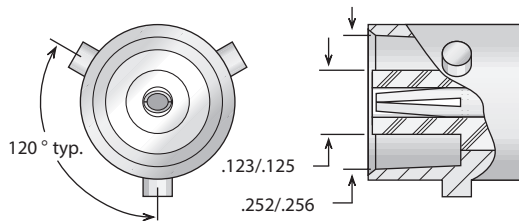

Plug Interface**

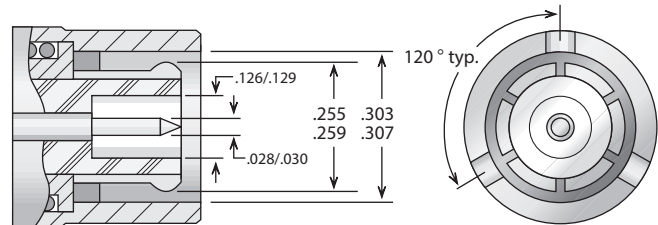

**Some proportions altered to illustrate detail.

Electrical:

Nominal Impedance: 50 ohms.
 Frequency Range: DC–10 GHz.
 Voltage Rating: 1,500 volts RMS.
 Dielectric Withstanding Voltage: 1,000 volts RMS.
 Insulation Resistance: 5,000 megohms.

Materials/Finishes:

Insulators: Teflon per ASTM D1710.
 Male Contacts: Brass per ASTM B16.
 Female Contacts: Beryllium Copper per ASTM B196.
 Contact Plating: Gold per MIL-DTL-45204.
 Gaskets: Silicone rubber per ZZ-R-765, Class II, Grade 50.
 Other Metal Parts: Brass per ASTM B16, plated Gold per MIL-DTL-45204.

All other specifications are in accordance with the latest issues of MIL-PRF-39012, or MIL-C-55235, or other applicable MIL specifications.

*These specifications are typical and may not apply to all connectors. Detailed specifications for individual connectors are available on request.

Straight & Right Angle Plugs - For Flexible Cable

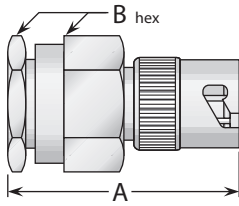

Figure 1
(Wedge clamp)

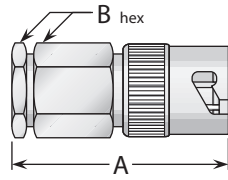

Figure 2
(Wedge clamp)

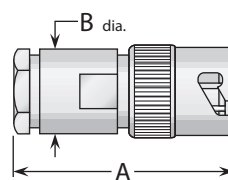

Figure 3
(Military clamp)

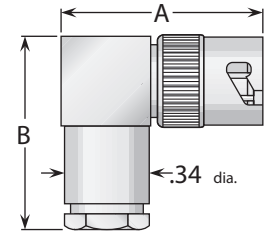

Figure 4
(Military clamp)

Cable Group	Figure	Dimensions		Plating		Delta P/N	Assembly Procedure/ Trim Code
		A	B	Body	Contact		
5	1	.940	.344	Gold	Gold	UG-1366/U	***
5	3	.900	.340	Gold	Gold	4401018G000-000	A/33
5, 6	4	.850	.730	Gold	Gold (C)	4404015G000-000	***
6	1	.940	.406	Gold	Gold	UG-1412/U	***
6	2	.940	.406	Gold	Gold (C)	4401013G005-000	***
6	3	.900	.340	Gold	Gold	4401013G000-000	A/33
7	2	.940	.500	Gold	Gold (C)	4401019G005-000	***
8A	2	.940	.344	Gold	Gold (C)	4401029G005-000	***
8B	3	.900	.340	Gold	Gold	4401043G000-000	A/33
9	2	.940	.344	Gold	Gold (C)	4401036G005-000	***
9	3	.900	.340	Gold	Gold	4401036G000-000	***
9	4	.910	.730	Gold	Gold (C)	4404036G000-000	A/34

Straight & Bulkhead Jacks - For Flexible Cable

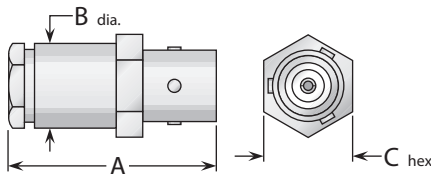

Figure 1
(Military clamp)

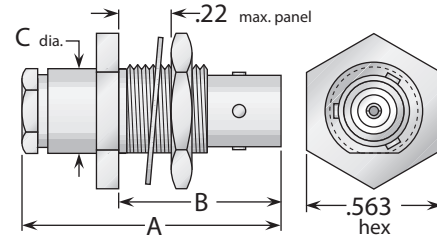

Figure 2
(Rear mount, wedge clamp)

Cable Group	Fig.	Dimensions			Mounting Figure	Plating		Delta P/N	Assembly Procedure/ Trim Code
		A	B	C		Body	Contact		
5, 6	1	.880	.340	.375	—	Gold	Gold	4408013G000-000	A/33
5, 6	2	1.05	.680	.410	62	Gold	Gold	UG-1413/U	***
7	1	.880	.340	.375	—	Gold	Gold	4408019G000-000	A/33
7	2	1.05	.680	.410	62	Gold	Gold	4416019G620-000	***
9	1	.880	.340	.375	—	Gold	Gold	4408036G000-000	A/33
9	2	.910	.680	.340	62	Gold	Gold (C)	4416036G620-000	***
11	2	.960	.680	.340	62	Gold	Gold (C)	4416038G620-000	***

- See page 209 for cable groups.
- Assembly procedures start on page 210.
- ***Contact factory for cable assembly instructions.
- See page 208 for mounting dimensions.
- (C) in contact plating column indicates captive contact.
- See page 6 for alternate body plating information.

Bulkhead & Panel Receptacles

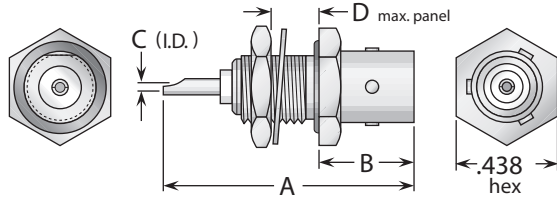

Figure 1
(Bulkhead jack, front mount, with mounting gasket)

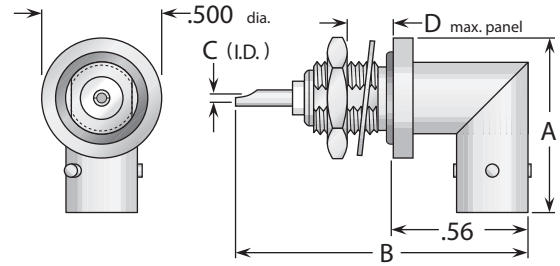

Figure 2
(Right angle bulkhead jack, front mount, with mounting gasket)

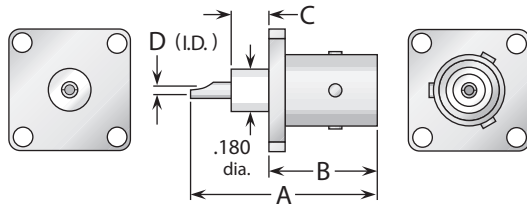

Figure 3
(Panel mount jack)

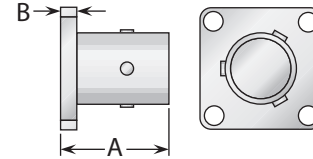

Figure 4
(Panel mount dummy receptacle)

Figure	Dimensions				Mounting Figure	Plating		Delta P/N
	A	B	C	D		Body	Contact	
1	1.11	.400	.040	.250	66	Gold	Gold (C)	UG-1365/U
2	.730	1.28	.040	.250	84	Gold	Gold (C)	4422000G840-001
3	.780	.450	.160	.040	04	Gold	Gold (C)	4413000G041-000
4	.470	.085	—	—	09	Silver	—	4463000A000-000

Bulkhead Mounted Jack-Jack Adapter (Connects two plugs)

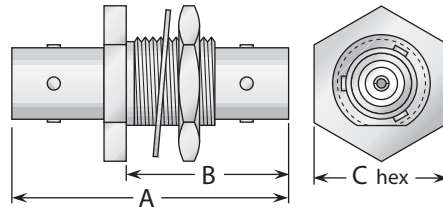

Figure 1

Figure	Dimensions			Max. Panel	Mounting Figure	Plating		Delta P/N
	A	B	C			Body	Contact	
1	1.20	.800	.562	.250	62	Gold	Gold (C)	4444000G628-000

• See page 208 for mounting dimensions. • (C) in contact plating column indicates captive contact.

General Description

Delta TRB connectors are compact, triaxial connectors with three-stud bayonet coupling. They are similar in size to BNC connectors, and can be used with a wide range of twinaxial and triaxial cables.

Their three-stud mating prevents rocking of mated pairs and ensures the low leakage and excellent shielding required in data-bus and other high-speed digital applications. Delta TRB connectors are designed and manufactured to meet the requirements of MIL-C-49142.

As with all other Delta connector series, we welcome your specifications for special configurations.

TRB Configurations

Straight Cable Plugs	157
Bulkhead Cable Jacks	157
Panel Jack Receptacles (square flange)	157
Bulkhead Jack Receptacles	157

TRB Specifications*

Plug Interface**

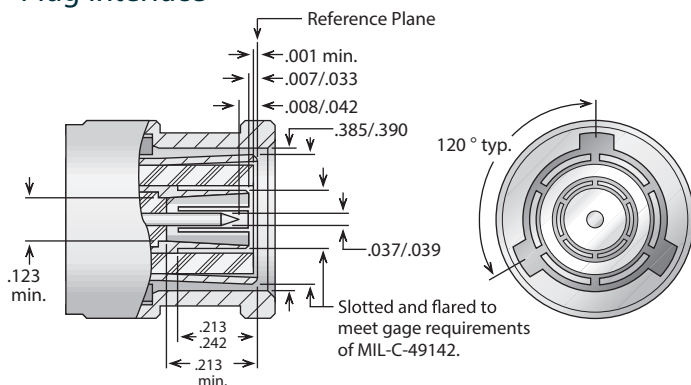

Electrical:

Nominal Impedance: Nonconstant.
 Frequency Range: DC–500 MHz.
 Voltage Rating: 400 volts RMS.
 Dielectric Withstanding Voltage: 1,200 VRMS.
 Insulation Resistance: 5,000 megohms.

Materials/Finishes:

Insulators: Teflon per ASTM D1710.
 Male Contacts: Brass per ASTM B16.
 Female Contacts: Beryllium Copper per ASTM B196.
 Contact Plating: Silver per ASTM B700, or Gold per MIL-DTL-45204.
 Gaskets: Silicone rubber per ZZ-R-765, Class II, Grade 50.
 Other Metal Parts: Brass per ASTM B16, plated: Silver per ASTM B700, or Nickel per AMS-QQ-N-290.

Jack Interface**

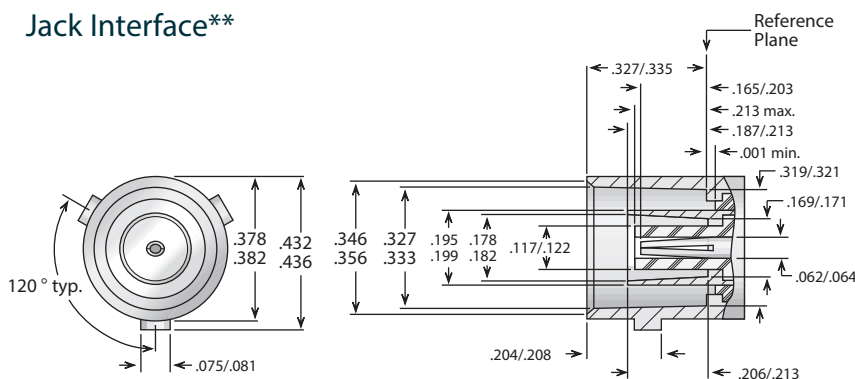

All other specifications are in accordance with the latest issues of MIL-PRF-39012, or MIL-C-49142, or other applicable MIL specifications, and interfaces are in accordance with MIL-STD-348.

*These specifications are typical and may not apply to all connectors. Detailed specifications for individual connectors are available on request.

**Some proportions altered to illustrate detail.

Cable Connectors

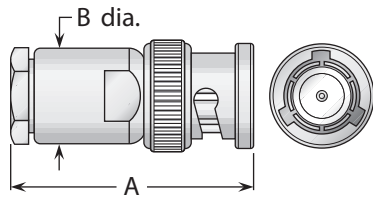

Figure 1
(Straight plug, wedge-clamp hardware)

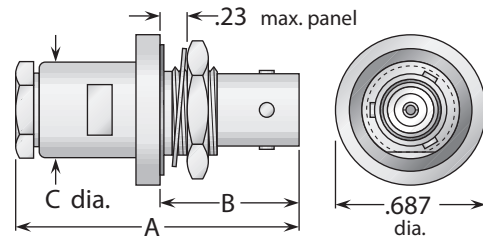

Figure 2
(Bulkhead jack, wedge-clamp hardware)

Cable Group	Fig.	Dimensions			Mounting Figure	Plating		Delta P/N	Assembly Procedure/Trim Code
		A	B	C		Body	Contact		
27	1	1.31	.500	—	—	Nickel	Gold (C)	2001099N000-000	***
27	2	1.50	.800	.500	59	Nickel	Gold (C)	2016099N591-000	***
28	1	1.88	.750	—	—	Nickel	Gold (C)	2001070N000-000	***
30	1	1.31	.500	—	—	Nickel	Gold (C)	2001235N000-000	***
30	2	1.50	.800	.500	59	Nickel	Gold (C)	2016235N591-001	***

Bulkhead & Panel Receptacles

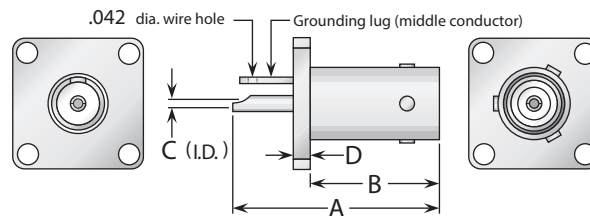

Figure 1
(Panel jack receptacle)

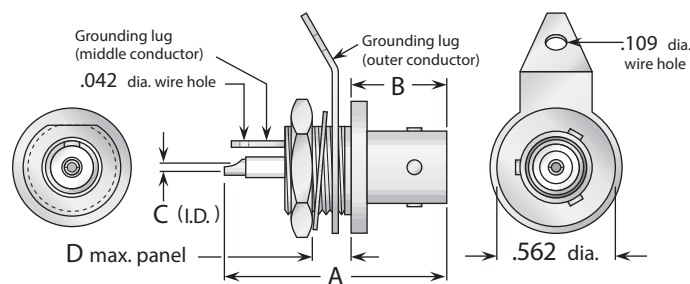

Figure 2
(Bulkhead jack receptacle, front mount)

Figure	Dimensions				Mounting Figure	Plating		Delta P/N
	A	B	C	D		Body	Contact	
1	1.07	.670	.040	.090	09	Nickel	Gold (C)	2013000N091-002
2	1.14	.490	.040	.125	62	Nickel	Gold (C)	2020000N621-003

- Contact factory for other twinaxial/triaxial cable accommodations.
- See page 209 for cable groups.
- See page 6 for alternate body plating information.
- ***Contact factory for cable assembly instructions.
- See page 208 for mounting dimensions.
- (C) in contact plating column indicates captive contact.

General Description

Delta TW34 series connectors are economical, medium-size twinaxial connectors with 3/4"-20 threaded coupling. Their characteristic 95 Ω impedance makes them ideal for use with RG-22/U and similar Belden, IBM, and other twinaxial cable commonly used in LAN installations.

Plugs in TW34 series contain two male contacts, and jacks contain two female contacts, with mating polarization provided by a key in the jack which engages a keyway in the plug. The insulators of both plugs and jacks are marked to indicate location of the bare-copper wire of the cable conductor pair.

Delta TW34 connectors are designed and manufactured to meet the requirements of MIL-C-3655.

TW34 Configurations

Cable Plugs.....	158	Panel Jack Receptacles (square flange)	160
Cable Jacks	159	In-Series Adapters	160
Bulkhead Jack Receptacles	159		

TW34 Specifications*

Plug Interface**

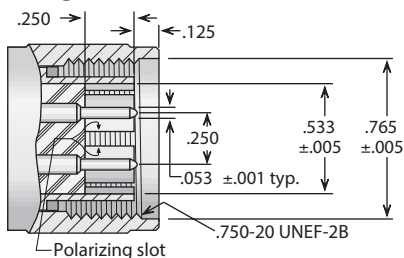

Jack Interface**

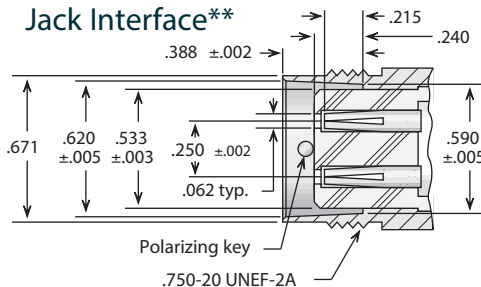

*These specifications are typical and may not apply to all connectors.

Detailed specifications for individual connectors are available on request.

**Some proportions altered to illustrate detail.

All other specifications are in accordance with the latest issues of MIL-PRF-39012, MIL-C-3655, or other applicable MIL specifications.

Electrical:

- Nominal Impedance: 95 ohms.
- Frequency Range: DC–200 MHz (Optimal), DC–500 MHz (Useable).
- Voltage Rating: 500 volts RMS.
- Dielectric Withstanding Voltage: 1,500 volts RMS.
- Insulation Resistance: 5,000 megohms.

Materials/Finishes:

- Insulators: Teflon per ASTM D1710.
- Male Contacts: Brass per ASTM B16.
- Female Contacts: Beryllium Copper per ASTM B196.
- Contact Plating : Silver per ASTM B700, or Gold per MIL-DTL-45204.
- Gaskets: Silicone rubber per ZZ-R-765, Class II, Grade 50.
- Other Metal Parts: Brass per ASTM B16, plated: Silver per ASTM B700, or Nickel per AMS-QQ-N-290.

Straight & Right Angle Plugs - Clamp Type For Flexible Cable

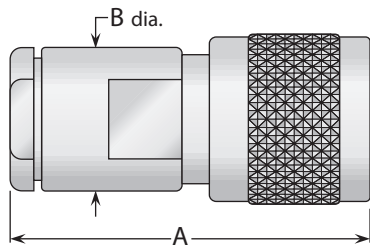

Figure 1

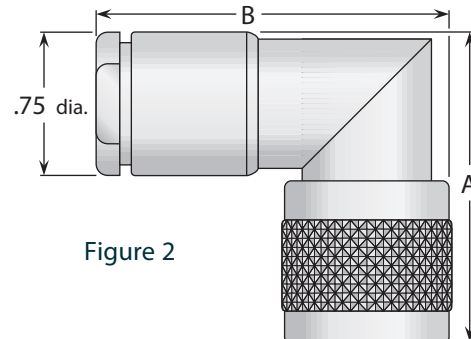

Figure 2

Cable Group	Figure	Dimensions		Plating		Delta P/N	Assembly Procedure/Trim Code
		A	B	Body	Contact		
27	1	1.88	.750	Nickel	Silver	2601099N000-000	***
28	1	1.88	.750	Nickel	Silver	UG-421B/U	***
28	2	1.56	1.88	Nickel	Silver	2604070N000-000	***
29	1	1.88	.750	Nickel	Silver	2601201N000-000	***
29	2	1.56	1.88	Nickel	Silver	2604201N000-000	***

Cable Jacks

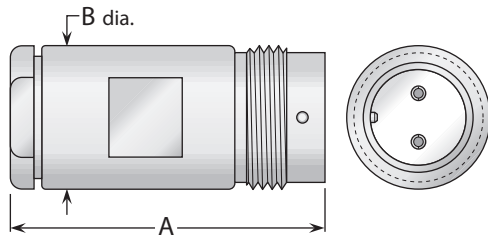

Figure 1
(Straight jack)

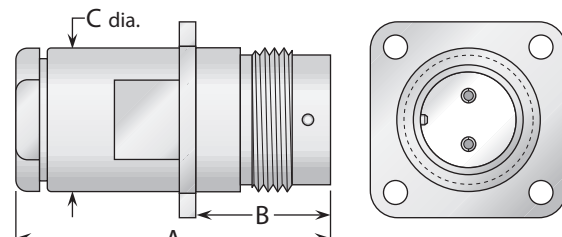

Figure 2
(Panel jack)

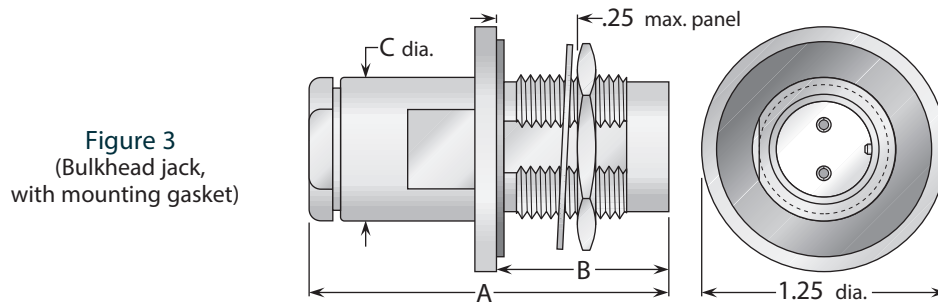

Figure 3
(Bulkhead jack,
with mounting gasket)

Cable Group	Fig.	Dimensions			Mounting Figure	Plating		Delta P/N	Assembly Procedure/Trim Code
		A	B	C		Body	Contact		
28	1	1.59	.750	—	—	Nickel	Silver	2608070N000-000	***
28	2	1.75	.690	.750	33	Nickel	Silver	UG-423B/U	***
28	3	1.75	.880	.750	51	Nickel	Silver	2616070N511-000	***
29	2	1.75	.690	.750	33	Nickel	Silver	2611201N331-000	***
29	3	1.75	.880	.750	51	Nickel	Silver	2616201N511-000	***

Bulkhead Receptacles - Solder Pot Contact

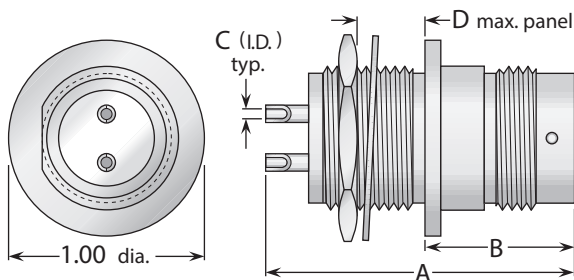

Figure 1
(Bulkhead jack receptacle, front mount)

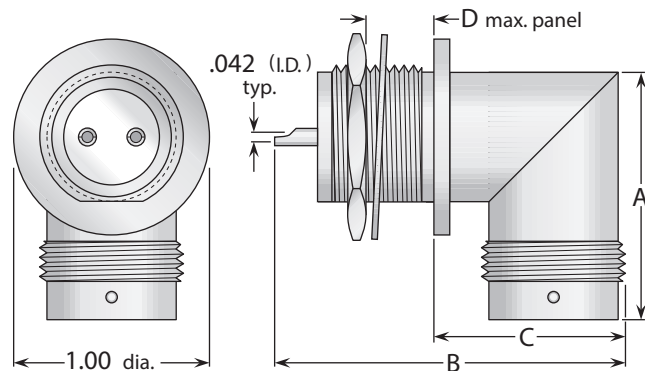

Figure 2
(Right angle bulkhead jack receptacle)

Figure	Dimensions				Mounting Figure	Plating		Delta P/N
	A	B	C	D		Body	Contact	
1	1.58	.785	.042	.250	51	Nickel	Silver (C)	2620000N511-000
2	1.53	1.75	.970	.250	51	Nickel	Silver (C)	2622000N511-000

- See page 209 for cable groups.
- ***Contact factory for cable assembly instructions.
- See page 208 for mounting dimensions.
- See page 6 for alternate body plating information.

Panel Jack Receptacle - Solder Pot Contact

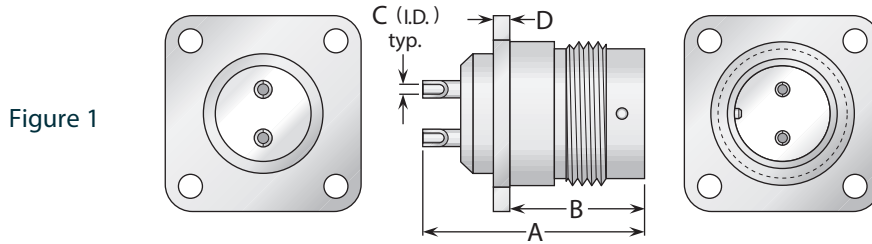
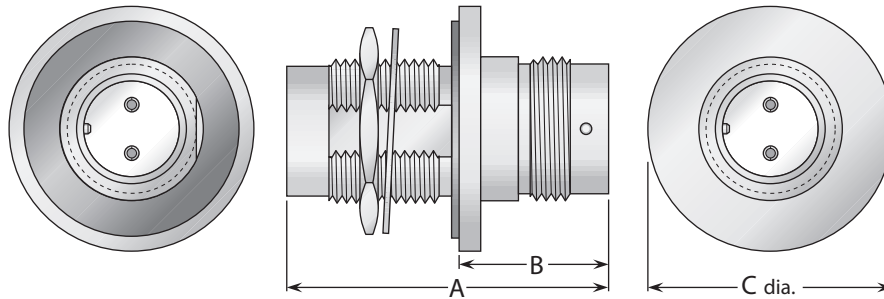

Figure	Dimensions				Mounting Figure	Plating		Delta P/N
	A	B	C	D		Body	Contact	
1	1.18	.710	.059	.080	33	Nickel	Silver (C)	UG-422/U

Bulkhead Jack-Jack Adapter (Connects Two Plugs)



Dimensions			Max. Panel	Mounting Figure	Plating		Delta P/N
A	B	C			Body	Contact	
1.67	.880	1.25	.250	51	Nickel	Silver (C)	UG-493A/U

Straight & Right Angle Adapters

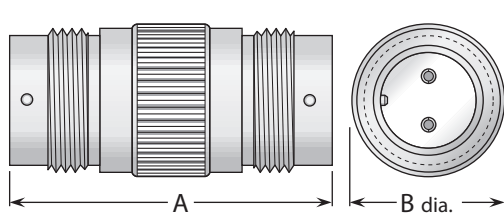

Figure 1
(Straight jack-jack; connects two plugs)

Figure 2
(Right angle jack-plug; connects one plug and one jack)

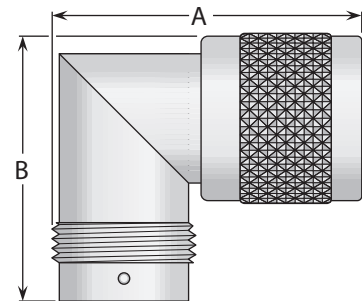

Figure	Dimensions		Plating		Delta P/N
	A	B	Body	Contact	
1	1.67	.750	Nickel	Silver (C)	2626000N000-000
2	1.56	1.38	Nickel	Silver (C)	UG-981/U

- See page 208 for mounting dimensions.
- (C) in contact plating column indicates captive contact.
- See page 6 for alternate body plating information.

General Description

Delta TWBNC connectors are compact, 78 Ω impedance twinaxial connectors with two-stud bayonet coupling. They are similar in size to BNC connectors, and are best suited for use with RG-108/U and similar twinaxial cables. Both plugs and jacks in TWBNC series contain one male contact and one female contact, with mating polarization provided by a stepped insulator. Delta TWBNC connectors are designed and manufactured to meet the requirements of MIL-C-3655.

TWBNC Specifications*

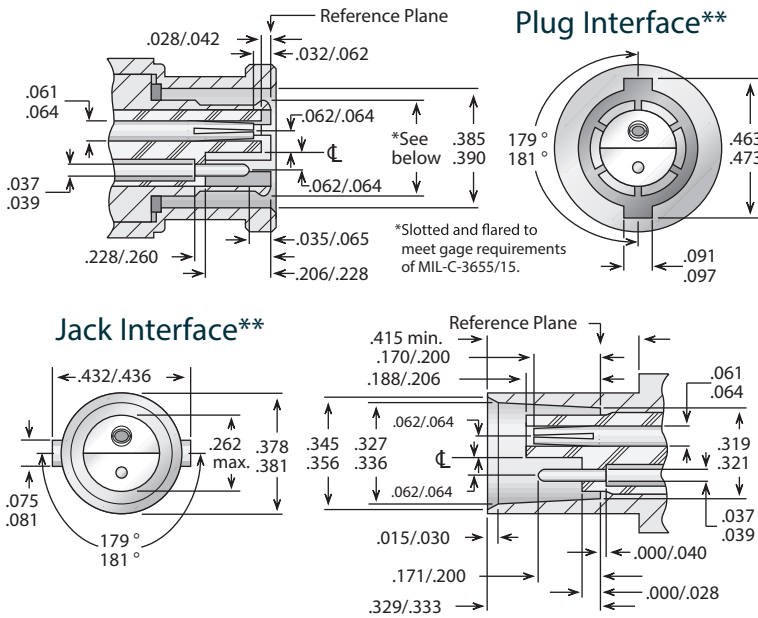

Electrical:
 Nominal Impedance: 78 Ω.
 Frequency Range: DC–500 MHz.
 Voltage Rating: 500 volts RMS.
 Dielectric Withstanding Voltage: 1,500 VRMS.
 Insulation Resistance: 5,000 megohms.

Materials/Finishes:
 Insulators: Teflon per ASTM D1710.
 Male Contacts: Brass per ASTM B16.
 Female Contacts: Beryllium Copper per ASTM B196.
 Contact Plating: Silver per ASTM B700, or Gold per MIL-DTL-45204.

Gaskets: Silicone rubber per ZZ-R-765, Class II, Grade 50.

Other Metal Parts: Brass per ASTM B16, plated: Silver per ASTM B700, or Nickel per AMS-QQ-N-290.

All other specifications are in accordance with the latest issues of MIL-PRF-39012, or MIL-C-3655, or other applicable MIL specifications, and interfaces are in accordance with MIL-STD-348.

*These specifications are typical and may not apply to all connectors. Detailed specifications for individual connectors are available on request.

**Some proportions altered to illustrate detail.

Cable Connectors - For Flexible Cable

Figure 1
(Cable plug, clamp type)

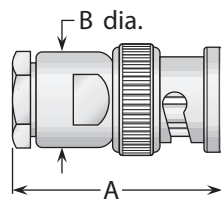

Figure 2
(Cable plug, crimp type)

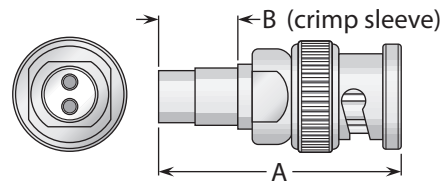

Figure 3
(Straight jack, clamp type)

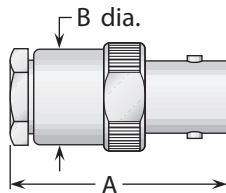
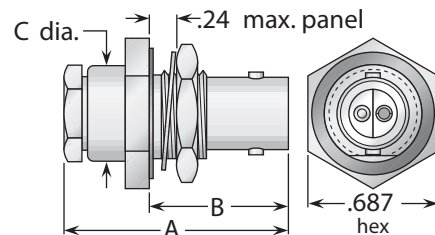

Figure 4
(Bulkhead jack, rear mount, clamp type)



Cable Group	Fig.	Dimensions			Mounting Figure	Plating		Delta P/N	Assembly Procedure/Trim Code
		A	B	C		Body	Contact		
27	1	1.16	.500	—	—	Nickel	Gold (C)	6101099N001-000	***
27	2	1.28	.410	—	—	Nickel	Silver (C)	6102099N001-000	***
27	3	1.13	.500	—	—	Nickel	Gold (C)	6108099N001-000	***
27	4	1.13	.810	.500	59	Nickel	Gold (C)	6116099N591-000	***

Jack Receptacles

Figure 1
(Bulkhead jack receptacle, front mount, solder pot contacts)

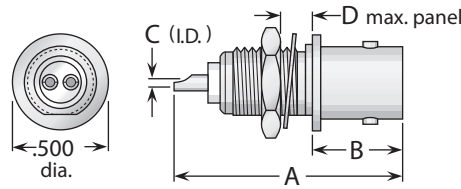

Figure 2
(Straight PCB receptacle)

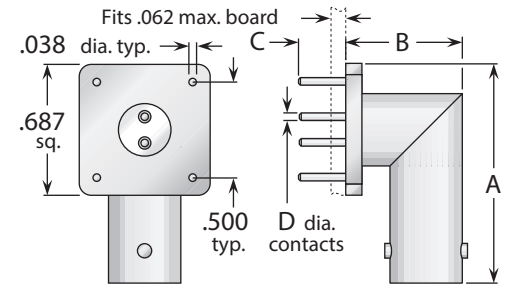
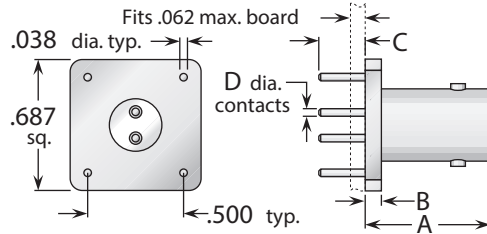

Figure 3
(Right angle PCB receptacle)

Figure	Dimensions				Mounting Figure	Plating		Delta P/N
	A	B	C	D		Body	Contact	
1	1.05	.470	.042	.106	65	Nickel	Gold (C)	612000N651-000
2	.650	.085	.125	.038	PCB04	Nickel	Silver (C)	615800N13P-000
3	1.34	.520	.125	.038	PCB04	Nickel	Silver (C)	616900N13P-000

Adapters

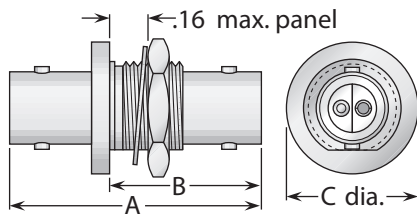

Figure 1
(Straight jack-jack bulkhead adapter; connects two plugs)

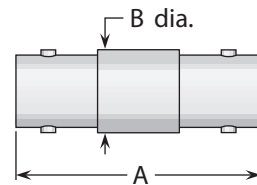

Figure 2
(Straight jack-jack adapter; connects two plugs)

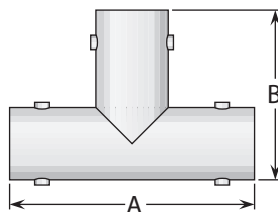

Figure 3
(Tee jack-jack-jack; connects three plugs)

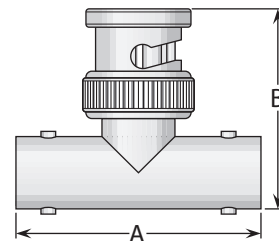

Figure 4
(Tee jack-jack-plug; connects two plugs and one jack)

Figure	Dimensions			Mounting Figure	Plating		Delta P/N
	A	B	C		Body	Contact	
1	1.28	.800	.625	59	Nickel	Gold (C)	612600N591-000
2	1.28	.440	—	—	Nickel	Gold (C)	612800N000-000
3	1.28	.890	—	—	Nickel	Gold (C)	615000N000-000
4	1.28	1.03	—	—	Nickel	Gold (C)	613000N000-000

- See page 209 for cable groups.
- See page 6 for alternate body plating information.
- ***Contact factory for cable assembly instructions.
- See page 208 for mounting dimensions.
- (C) in contact plating column indicates captive contact.

General Description

Delta UHF connectors are economical, medium size, nonconstant impedance connectors with $\frac{5}{8}$ "-24 threaded coupling. These connectors are not weatherproof. UHF connectors are best suited for use in low-frequency applications. Adapters between UHF and other series are shown starting on page 174.

UHF Specifications

Electrical:

Nominal Impedance: Nonconstant.
 Frequency Range: DC–200 MHz, use with caution to 500 MHz.
 Voltage Rating: 500 volts RMS.

Materials/Finishes:

Insulators: Teflon per ASTM D1710.
 Male Contacts: Brass per ASTM B16.
 Female Contacts: Beryllium Copper per ASTM B196.

Contact Plating: Silver per ASTM B700.
 Other Metal Parts: Brass per ASTM B16, plated Silver per ASTM B700, or Nickel per AMS-QQ-N-290.

Straight Plug - For Flexible Cable

Figure 1
(Compression clamp)

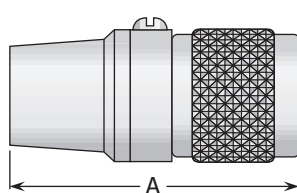
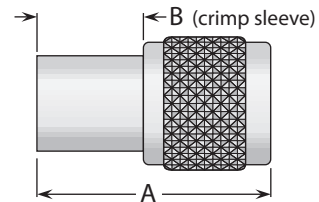

Figure 2
(Crimp type)



Cable Group	Figure	Dimension		Plating		Delta P/N	Assembly Procedure/Trim Code
		A	B	Body	Contact		
2, 3	1	1.56	—	Silver	Silver (C)	PL-259A	***
3	2	1.44	.630	Nickel	Silver (C)	5003005N001-000	***
5	2	1.44	.500	Nickel	Silver (C)	5003012N001-000	***
6	2	1.44	.500	Nickel	Silver (C)	5003013N001-000	***
7	1	1.56	—	Silver	Silver (C)	UG-203/U	***

Bulkhead & Panel Receptacles

Figure 1
(Panel jack receptacle)

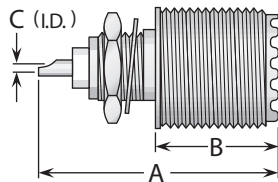
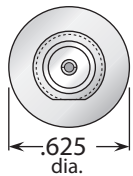
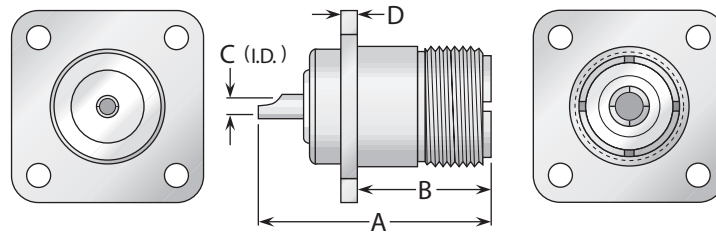

Figure 2
(Bulkhead jack receptacle, front mount)

Figure 3
(Panel plug receptacle)

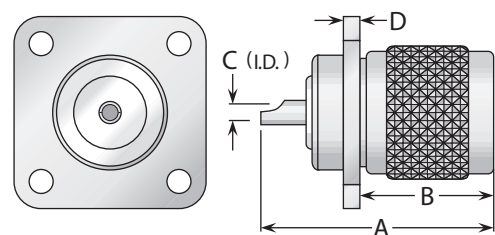

Figure	Dimensions				Mounting Figure	Plating		Delta P/N
	A	B	C	D		Body	Contact	
1	1.18	.700	.100	.080	33	Nickel	Silver (C)	5013000N331-000
2	1.25	.657	.062	.125	65	Nickel	Silver (C)	5020000N651-000
3	1.03	.720	.100	.080	33	Nickel	Silver (C)	5023000N331-001

- See page 209 for cable groups.
- ***Contact factory for cable assembly instructions.
- See page 208 for mounting dimensions.
- (C) in contact plating column indicates captive contact.
- See page 6 for alternate body plating information.

General Description

Delta 1.0 / 2.3 series jacks are compact, high-performance connectors that mate with all five standard types of 50 ohm 1.0 / 2.3 series plugs.

Designed to meet all applicable CECC and DIN requirements, they offer good electrical performance up to 10 GHz.

These connectors are ideal for use in rack-and-panel applications with appropriate slide-on mating plugs.

Current configurations include direct-solder bulkhead jacks for semi-rigid cable, along with two- and four-hole flange panel jacks with post contacts. New types are being added to our product line, so please call with your requirements for other 1.0 / 2.3 configurations.

1.0/2.3 Configurations

Straight P.C. Board Jack Receptacle	164
Panel Jack Receptacles	165
Bulkhead Cable Jacks.....	165

1.0/2.3 Specifications*

Jack Interface**

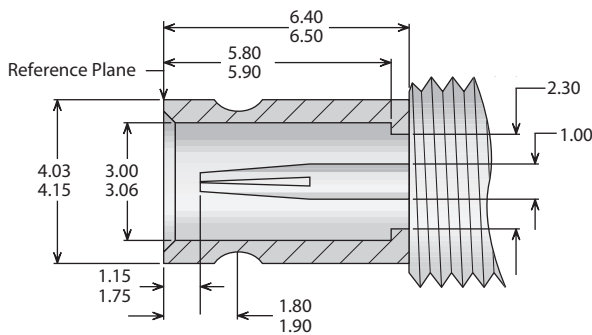

**Some proportions altered to illustrate detail. Dimensions in mm.

Electrical:

Nominal Impedance: 50 ohms.
 Frequency Range: DC-10 GHz.
 Voltage Rating: 250 volts RMS (dependent on cable).
 Dielectric Withstanding Voltage : 750 volts RMS.
 Insulation Resistance: 1,000 megohms.

Materials/Finishes:

Insulators: Teflon per ASTM D1710.
 Female Contacts: Beryllium Copper per ASTM B196.
 Contact Plating : Gold per MIL-DTL-45204.
 Gaskets: Silicone rubber per ZZ-R-765, Class II, Grade 50.
 Other Metal Parts: Brass per ASTM B16, gold plated per MIL-DTL-45204.

All other specifications are in accordance with the latest issues of CECC 22 230, DIN 41626, or DIN 47297, or other applicable specifications, and interfaces are in accordance with IEC 169-29.

*These specifications are typical and may not apply to all connectors. Detailed specifications for individual connectors are available on request.

Printed-Circuit Board Jack Receptacle

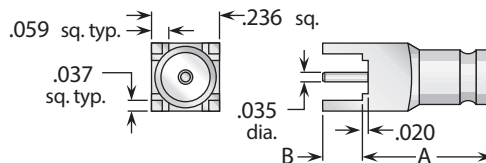

Figure 1
(Straight through-hole mount)

Figure	Dimensions		Max. Board	Mounting Figure	Plating		Delta P/N
	A	B			Body	Contact	
1	.433	.138	.100	PCB06	Gold	Gold (C)	4267000G91P-001

• See page 208 for mounting figures. • (C) in contact plating column indicates captive contact.

Panel Jack Receptacles - Post Contact

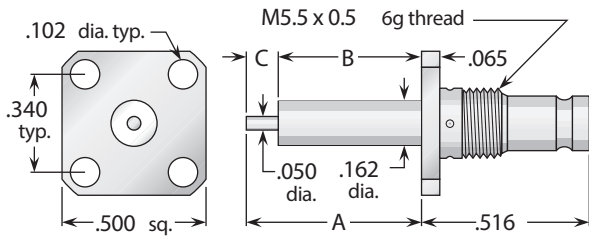

Figure 1 (1/2" square flange)

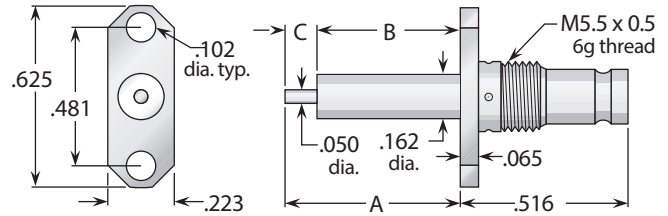
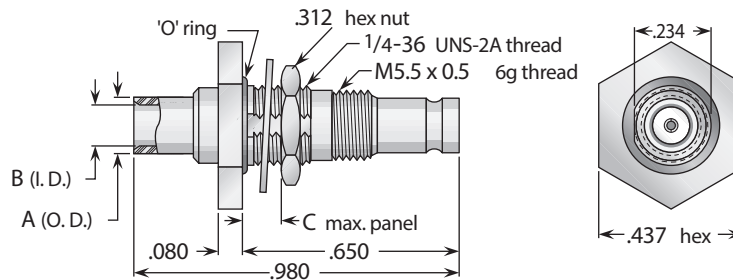

Figure 2 (2-hole flange)

Figure	Dimensions			Plating		Delta P/N
	A	B	C	Body	Contact	
1	.705	.590	.115	Gold	Gold (C)	4258000G051-000
1	.250	.150	.100	Gold	Gold (C)	4258000G051-010
2	.705	.590	.115	Gold	Gold (C)	4258000G921-002
2	.250	.150	.100	Gold	Gold (C)	4258000G921-003

Bulkhead Jacks - Direct Solder For Semi-Rigid Cable



Cable Group	Dimensions			Mounting Figure	Plating		Delta P/N
	A	B	C		Body	Contact	
13	.184	.145	.125	67	Gold	Gold	4217031G673-000
14	.120	.088	.125	67	Gold	Gold	4217025G673-000

Assembly Procedure

- Trim cable as shown.
Remove any burrs from jacket and center conductor.
Tin center conductor.
- Solder contact to center conductor, with end of contact flush with cable dielectric.
Remove any excess solder from outside of contact.
- Insert cable into body until end of cable jacket stops against internal shoulder.
Solder cable jacket to body.

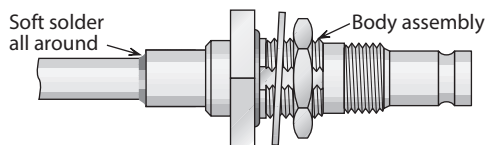
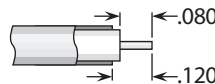

Receptacles also available with other contact / insulator configurations. • (C) in contact plating column indicates captive contact.
See page 208 for mounting figures. • See page 209 for cable groups.

General Description

Delta 7/16 series connectors are medium size, 50 Ω impedance connectors with M29 x 1.5 metric threaded coupling. These rugged connectors conform to DIN 47223, and feature good power-handling capability along with VSWR as low as 1.07:1 @ 2 GHz. Because these connectors are designed to minimize signal distortion from intermodulation, silver plating is standard. The optional Albaloy plating provides greatly increased tarnish resistance while preserving the connectors' low intermodulation characteristics; optional nickel plating should only be specified when low intermodulation is not a concern in your system design.

As with our other connector series, Delta's customer-driven design results in 7/16 series connectors with practical and unique features that make your design and assembly process easier. Some of these include:

- VersaCom combination cable connectors (page 170) let you stock various body and cable attachment subassemblies, and assemble them into straight or right angle connectors as needed.
- PressMount receptacles (pages 171 and 172) mount securely in a single round hole, saving space on your components and reducing your housing fabrication costs.
- Panel receptacles with flange sizes to match the same hole pattern as standard type N connectors, letting you drill one hole pattern and mount BNC, N, SMA, TNC, or 7/16 series connectors as needed.
- All Delta 7/16 series plugs feature a coupling nut with a knurled surface for secure grip when hand-tightening, and a hex for tightening with a wrench. All can be supplied with full-length hex coupling nuts as well.

Our 7/16 series product line is still growing, so please call if you don't see what you need.

7/16 Configurations

Straight Cable Plugs	167
Right Angle Cable Plugs	167
Panel Cable Jacks	168
Bulkhead Cable Jacks	169
VersaCom Combination Cable Connectors	170
PressMount Jack Receptacles	171
Panel Jack Receptacles (Solder pot contact)	171
Panel Jack Receptacles (Threaded contact)	171
Panel Jack Receptacles (Tab contact)	172

Panel Jack Receptacles (Slotted contact)	172
Panel Jack Receptacles (Post contact)	172
PressMount Plug Receptacles	173
Panel Plug Receptacles (Solder pot contact)	173
Panel Plug Receptacles (Threaded contact)	173
Panel Plug Receptacles (Tab contact)	174
Panel Plug Receptacles (Slotted contact)	174
Panel Plug Receptacles (Post contact)	174
Adapters Within and Between Series	175

7/16 Specifications*

Electrical:

Nominal Impedance: 50 ohms.
 Frequency Range: DC–7.5 GHz.
 Voltage Rating: 2,700 volts RMS.
 Dielectric Withstanding Voltage: 4,000 VRMS.
 Insulation Resistance: 10,000 megohms.

Materials/Finishes:

Insulators: Teflon per ASTM D1710.
 Male Contacts: Brass per ASTM B16.
 Female Contacts: Spring Brass per ASTM B16,
 or phosphor bronze per ASTM B139

Contact Plating: Silver per ASTM B700,
 or Gold per MIL-DTL-45204.

Gaskets: Silicone rubber per ZZ-R-765,
 Class II, Grade 50.

Other Metal Parts: Brass per ASTM B16,
 plated Silver per
 ASTM B700.

All other specifications are in accordance with the latest issues of DIN 47223 or other applicable IEC, VG, or CECC specifications.

*These specifications are typical and may not apply to all connectors. Detailed specifications for individual connectors are available on request.

Jack Interface**

(All dimensions in millimeters.)

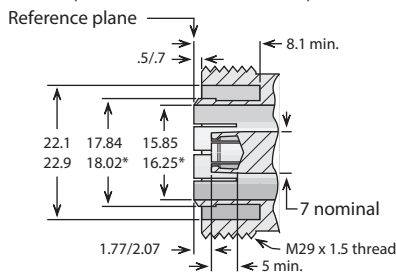

* Dimensions before slotting.
 Inner and outer contacts slotted and flared to meet performance requirements.

Plug Interface**

(All dimensions in millimeters.)

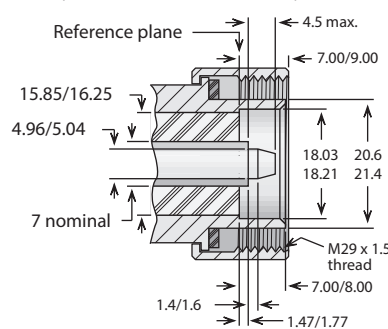

**Some proportions altered to illustrate detail.

Straight Plug - For Flexible & Semi-Rigid Cable

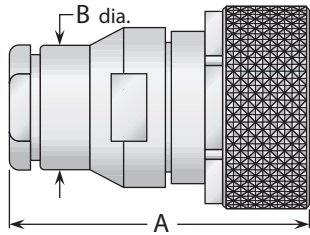

Figure 1
(Clamp type for flexible cable)

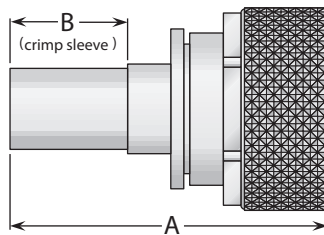

Figure 2
(Crimp type for flexible cable)

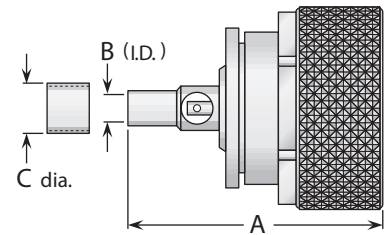

Figure 3
(Solder type for semi-rigid cable)

Cable Group	Figure	Dimensions			Plating		Delta P/N	Assembly Procedure/ Trim Code
		A	B	C	Body	Contact		
2, 3	1	1.85	.750	—	Silver	Gold (C)	9201004A001-000	A/01
4	1	1.85	.750	—	Silver	Gold (C)	9201079A001-000	A/01
3, 4	2	1.89	.630	—	Silver	Silver (C)	9203005A001-000	***
12	3	1.72	.254	.387	Silver	Silver (C)	9201050A003-002	***
13	3	1.59	.148	.319	Silver	Silver (C)	9201031A003-000	***

Right Angle Plug - For Flexible & Semi-Rigid Cable

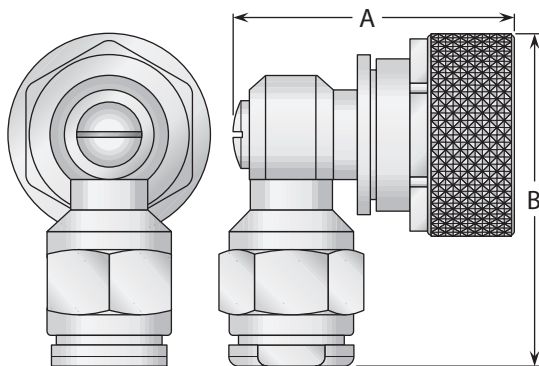

Figure 1
(Clamp type for flexible cable
or solder-clamp for semi-rigid cable)

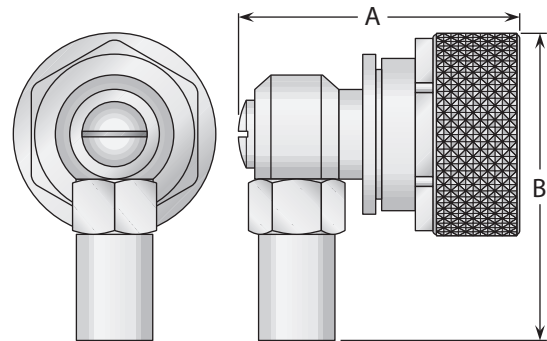

Figure 2
(Crimp type for flexible cable)

Cable Group	Figure	Dimensions		Plating		Delta P/N	Assembly Procedure/ Trim Code
		A	B	Body	Contact		
2, 3	1	1.68	2.04	Silver	Silver (C)	9205005A001-002	A/35
4	1	1.68	2.04	Silver	Silver (C)	9205079A001-001	A/35
5, 6	1	1.68	1.53	Silver	Silver (C)	9205015A001-000	A/36
12	1	1.68	2.04	Silver	Silver (C)	9205050A003-001	***
13	1	1.68	1.53	Silver	Silver (C)	9205031A003-000	***
3, 4	2	1.68	1.86	Silver	Silver (C)	9207005A001-000	B/31
5	2	1.68	1.73	Silver	Silver (C)	9207017A001-000	B/31
6	2	1.68	1.73	Silver	Silver (C)	9207015A001-000	B/31

- See page 209 for cable groups.
- Cable assembly instructions start on page 210.
- ***Contact factory for cable assembly instructions.
- (C) in contact plating column indicates captive contact.
- See page 6 for alternate body plating information.

Panel Mounted Jacks - For Flexible & Semi-Rigid Cable

Figure 1
(Crimp type for flexible cable, standard flange)

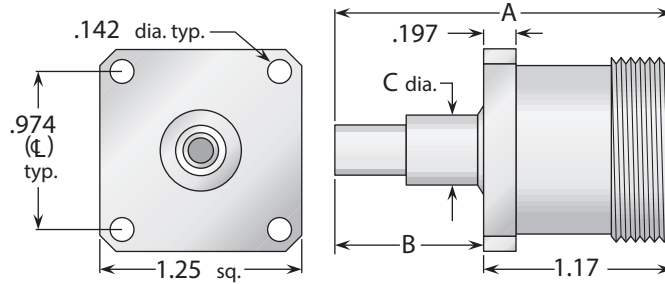

Figure 2
(Crimp type for flexible cable, 1" square flange; interchangeable with type N standard flange)

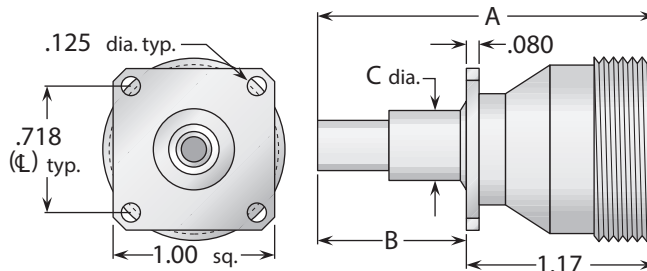

Figure 3
(Solder type for semi-rigid cable, standard flange, with 'O' ring seal)

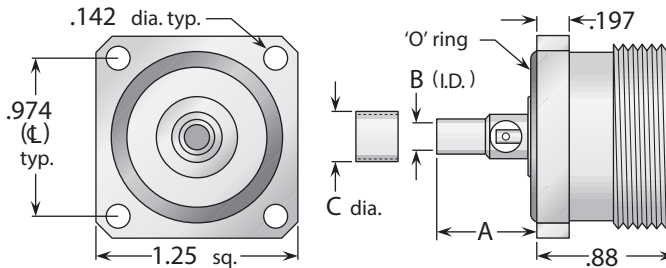
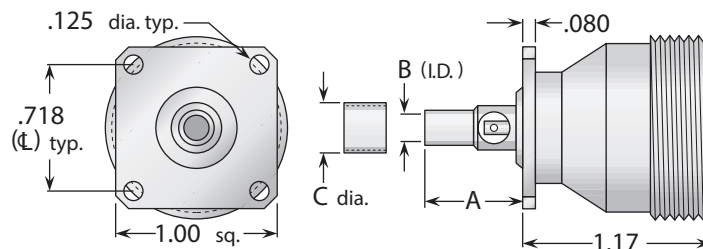

Figure 4
(Solder type for semi-rigid cable, 1" square flange; interchangeable with type N standard flange)



Cable Group	Figure	Dimensions			Plating		Delta P/N	Assembly Procedure/ Trim Code
		A	B	C	Body	Contact		
3, 4	1	2.34	1.17	.625	Silver	Silver	9255005A911-000	B/19
6	1	2.21	1.04	.625	Silver	Silver	9255015A911-000	B/19
3, 4	2	2.34	1.17	.625	Silver	Silver	9255005A331-000	B/19
6	2	2.21	1.04	.625	Silver	Silver	9255015A331-000	B/19
12	3	.600	.254	.387	Silver	Silver (C)	9211050A911-001	***
13	3	.600	.148	.319	Silver	Silver (C)	9211031A911-001	***
12	4	.600	.254	.387	Silver	Gold (C)	9211050A331-000	***
13	4	.600	.148	.319	Silver	Gold (C)	9211031A331-000	***

- See page 209 for cable groups. • Cable assembly instructions start on page 210. • ***Contact factory for cable assembly instructions.
- (C) in contact plating column indicates captive contact. • See page 6 for alternate body plating information.
- 7/16 connectors with 1" square flanges have lower maximum power rating than standard-flange connectors—contact factory for details.

Bulkhead Mounted Jacks - For Flexible & Semi-Rigid Cable

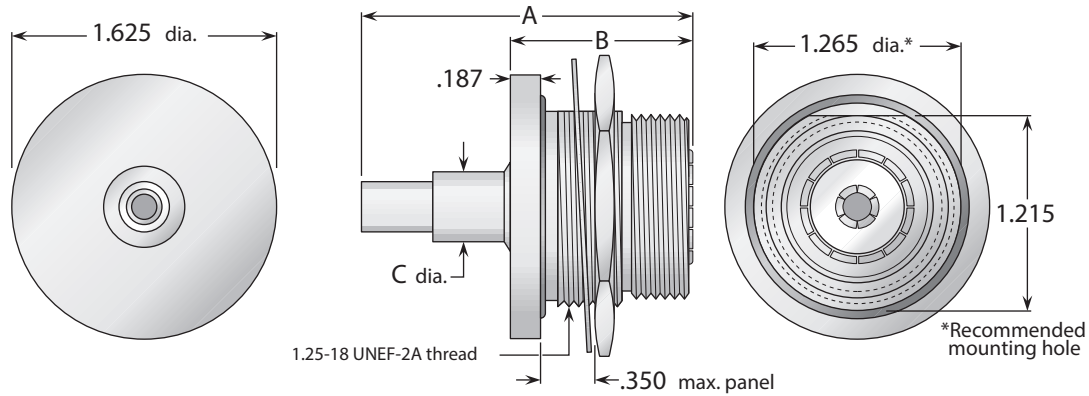

Figure 1
(Crimp type for flexible cable)

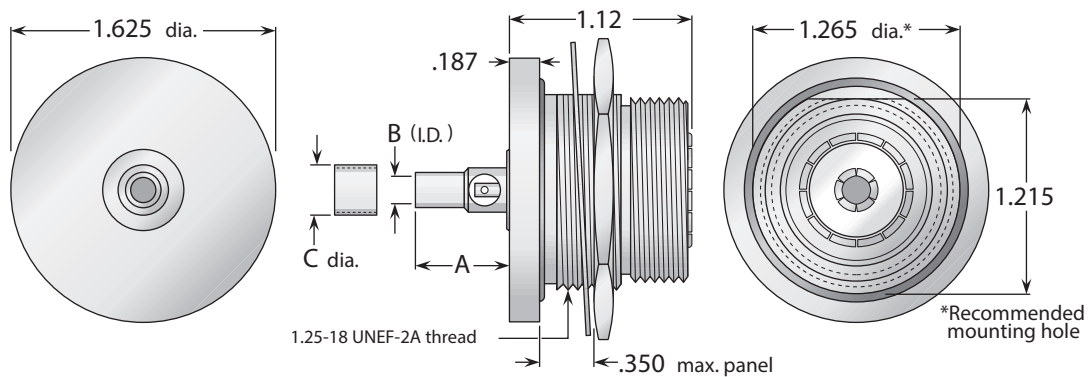

Figure 2
(Solder type for semi-rigid cable)

Cable Group	Figure	Dimensions			Plating		Delta P/N	Assembly Procedure/ Trim Code
		A	B	C	Body	Contact		
3, 4	1	2.34	1.17	.625	Silver	Silver (C)	9219005A911-000	B/19
12	2	.470	.254	.387	Silver	Silver (C)	9216050A911-000	***
13	2	.600	.148	.319	Silver	Silver (C)	9216031A911-000	***

- See page 209 for cable groups.
- Cable assembly instructions start on page 210.
- ***Contact factory for cable assembly instructions.
- (C) in contact plating column indicates captive contact.
- See page 6 for alternate body plating information.

The Delta Versatile Combination Connector System

By purchasing VersaCom body assemblies and cable fittings, you can easily assemble straight or right angle connectors as needed—eliminating separate stocks of complete connectors with different body styles and cable attachments

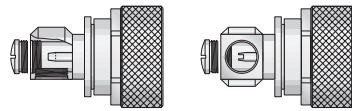

Body assembly (plug type, side and bottom views)

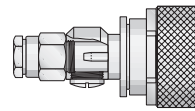

Body assembly and clamp type cable fitting, combined in straight configuration

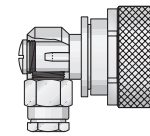

Same parts in right-angle configuration.

VersaCom Body Assemblies

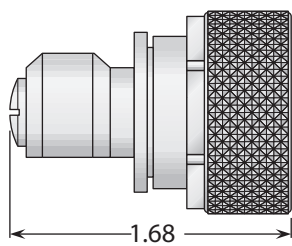

Figure 1

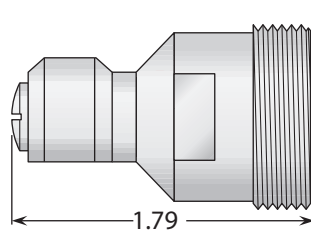

Figure 2

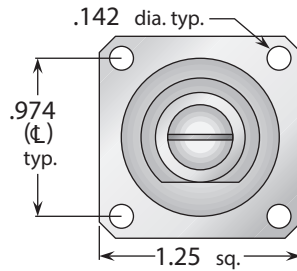

Figure 3

Body Style	Figure	Body Plating	Contact Plating	Delta P/N
Plug	1	Silver	Silver (C)	9203000A001-000
Jack	2	Silver	Silver (C)	9208000A001-000
Panel Jack	3	Silver	Silver (C)	9211000A911-001

Cable Fittings For VersaCom Connectors

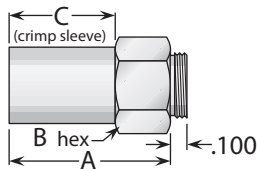

Figure 1
(Crimp type for flexible cable)

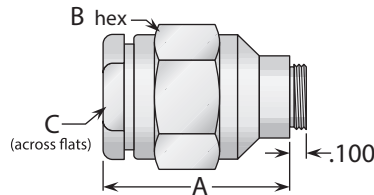

Figure 2
(Clamp type for flexible cable or solder-clamp for semi-rigid cable)

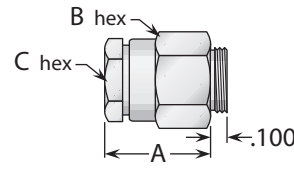

Figure 3
(Clamp type for flexible cable or solder-clamp for semi-rigid cable)

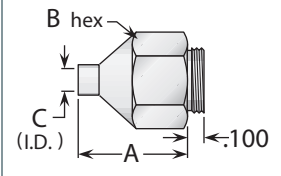

Figure 4
(Direct solder for semi-rigid cable)

Cable Group	Figure	Dimensions			Plating	Delta P/N	Assembly Procedure/Trim Code
		A	B	C			
2	1	.960	.500	.630	Silver	10-10676-01-AG	B/31
2, 3	2	1.14	.750	.625	Silver	10-10681-01-AG	A/35
3, 4	1	.960	.500	.630	Silver	10-10677-01-AG	B/31
4	2	1.14	.750	.625	Silver	10-10682-01-AG	A/35
5, 6	3	.630	.500	.437	Silver	10-10683-01-AG	A/36
5	1	.830	.500	.500	Silver	10-10678-01-AG	B/31
6	1	.830	.500	.500	Silver	10-10679-01-AG	B/31
7	1	.830	.500	.500	Silver	10-10680-01-AG	B/31
7	3	.630	.500	.437	Silver	10-10684-01-AG	A/36
12	2	1.14	.750	.625	Silver	10-10685-01-AG	***
12	4	.630	.500	.254	Silver	10-10687-01-AG	***
13	3	.630	.500	.437	Silver	10-10686-01-AG	***
13	4	.630	.500	.143	Silver	10-10688-01-AG	***

- See page 209 for cable groups.
- Cable assembly instructions start on page 210.
- ***Contact factory for cable assembly instructions.
- (C) in contact plating column indicates captive contact.
- See page 6 for alternate body plating information.

Jack Receptacles - Solder Pot Contact

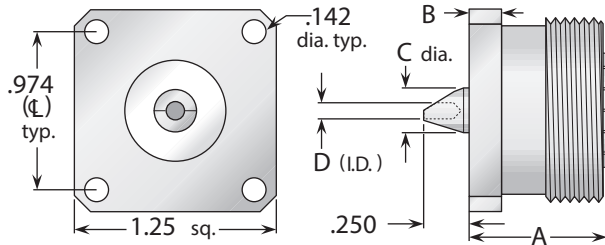

Figure 1
(Standard flange)

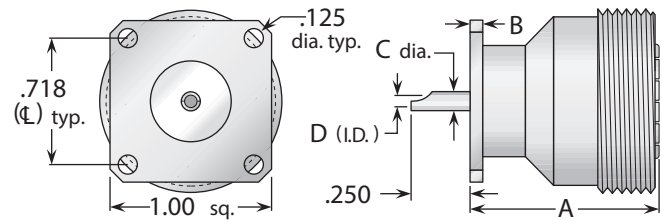
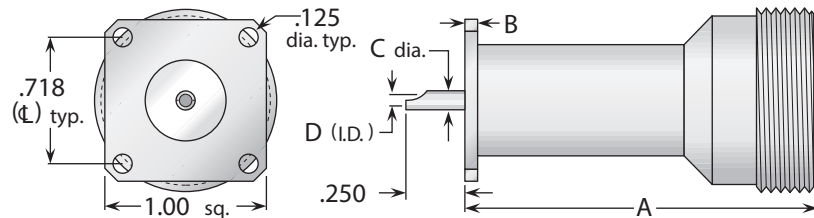
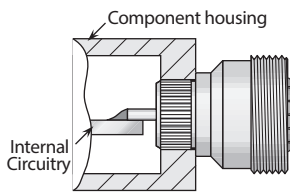

Figure 2
(1" square flange, interchangeable with type N standard flange size)

Figure 3
(1" square flange, interchangeable with type N standard flange size)



Delta PressMount Receptacles



These connectors eliminate the need for complicated mounting hole patterns and mounting hardware. They are simply pressed into a single through hole, and the precisely-engineered knurled mounting section provides retention strength greater than normal mating and unmating forces. An integral shoulder provides a positive stop when mounting.

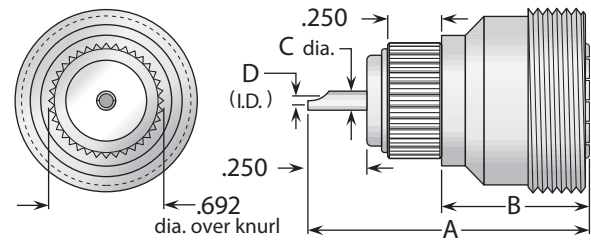

Figure 4
(PressMount)

Figure	Dimensions				Mounting Figure	Plating		Delta P/N
	A	B	C	D		Body	Contact	
1	.850	.197	.274	.100	See above	Silver	Silver (C)	9213000A911-003
2	1.17	.080	.120	.100	33	Silver	Gold (C)	9213000A911-004
3	2.17	.080	.120	.100	33	Silver	Gold (C)	9213000A911-010
4	1.42	.819	.120	.100	.688±.001 dia.	Silver	Gold (C)	9220000A911-000

Panel Jack Receptacles - Threaded Contact

Figure 1
(Standard flange)

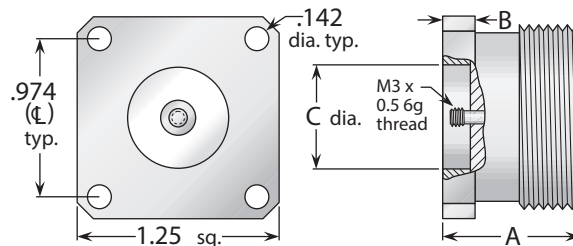

Figure	Dimensions			Mounting Figure	Plating		Delta P/N
	A	B	C		Body	Contact	
1	.850	.197	.630	See above	Silver	Silver (C)	9258000A911-000

- (C) in contact plating column indicates captive contact.
- See page 6 for alternate body plating information.
- All items are available with other flange sizes and contact configurations.

• 7/16 connectors with 1" square flanges have lower maximum power rating than standard-flange connectors—contact factory for details.

Panel Jack Receptacles - Tab Contact

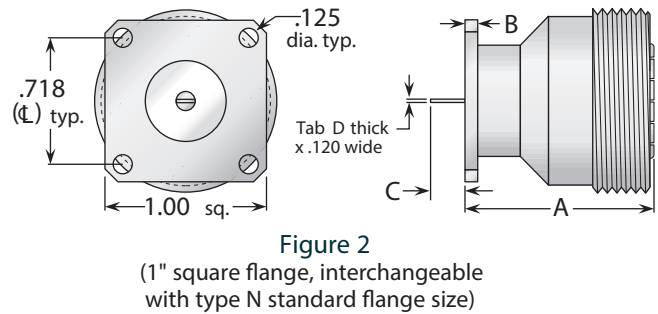
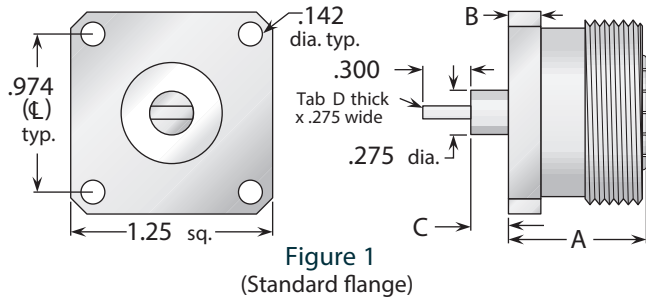

Figure	Dimensions				Mounting Figure	Plating		Delta P/N
	A	B	C	D		Body	Contact	
1	.850	.197	.200	.100	See above	Silver	Silver (C)	9258000A911-006
2	1.17	.080	.100	.005/.008	33	Silver	Gold (C)	9258000A331-000

Panel Jack Receptacles - Slotted Contact

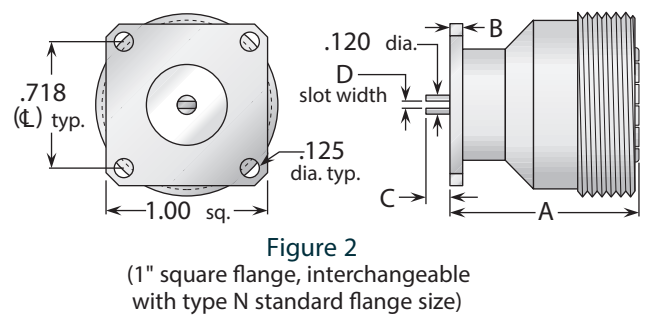
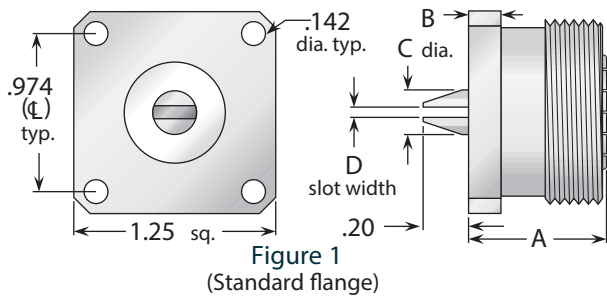

Figure	Dimensions				Mounting Figure	Plating		Delta P/N
	A	B	C	D		Body	Contact	
1	.850	.197	.276	.095	See above	Silver	Silver (C)	9258000A911-007
2	1.17	.080	.050	.013/.017	33	Silver	Gold (C)	9258000A331-010

Panel Jack Receptacles - Post Contact

Figure 1
(1" square flange, interchangeable with type N standard flange size)

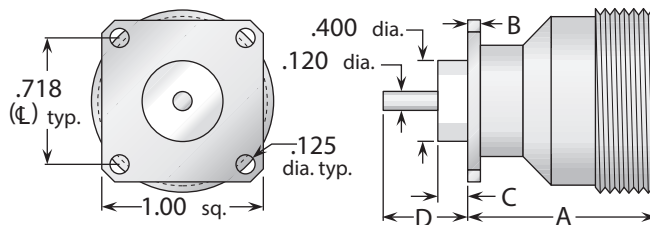

Figure	Dimensions				Mounting Figure	Plating		Delta P/N
	A	B	C	D		Body	Contact	
1	1.17	.080	.325	.500	33	Silver	Silver (C)	9258000A331-005
1	1.17	.080	.000	.750	33	Silver	Silver (C)	9258000A331-002
1	1.17	.080	.000	.562	33	Silver	Silver (C)	9258000A331-003

- (C) in contact plating column indicates captive contact.
- See page 6 for alternate body plating information.
- All items are available with other flange sizes and contact configurations.
- 7/16 connectors with 1" square flanges have lower maximum power rating than standard-flange connectors—contact factory for details.

Plug Receptacles - Solder Pot Contact

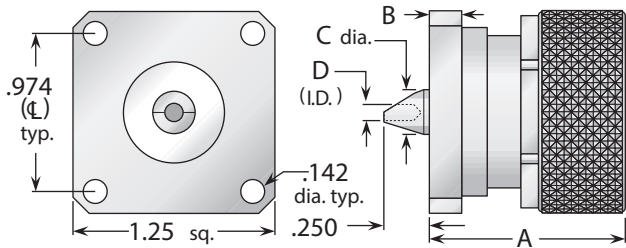

Figure 1
(Standard flange)

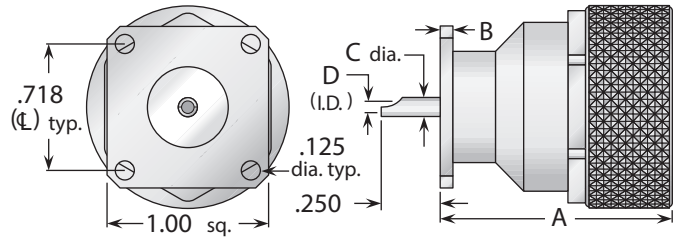
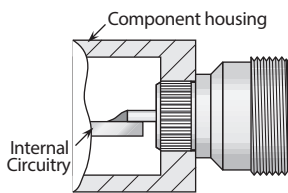

Figure 2
(1" square flange, interchangeable with type N standard flange size)



Delta PressMount Receptacles

These connectors eliminate the need for complicated mounting hole patterns and mounting hardware.

They are simply pressed into a single through hole, and the precisely-engineered knurled mounting section provides retention strength greater than normal mating and unmating forces. An integral shoulder provides a positive stop when mounting.

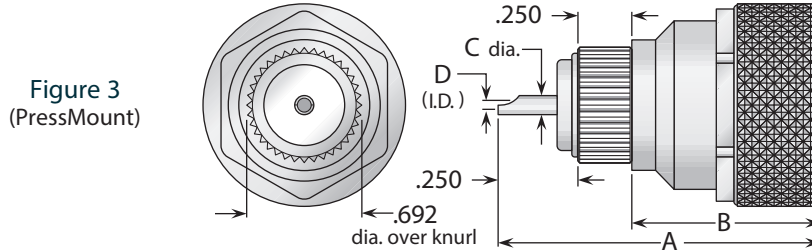

Figure 3
(PressMount)

Figure	Dimensions				Mounting Figure	Plating		Delta P/N
	A	B	C	D		Body	Contact	
1	1.21	.197	.274	.100	See above	Silver	Silver (C)	9223000A911-000
2	1.40	.080	.120	.100	33	Silver	Gold (C)	9223000A911-003
3	1.65	1.05	.120	.100	.688±.001 dia.	Silver	Gold (C)	9224000A911-000

Panel Plug Receptacles - Threaded Contact

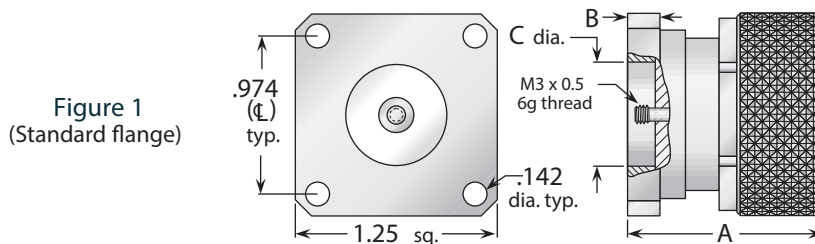

Figure 1
(Standard flange)

Figure	Dimensions			Mounting Figure	Plating		Delta P/N
	A	B	C		Body	Contact	
1	1.21	.197	.630	See above	Silver	Silver (C)	9223000A911-001

- (C) in contact plating column indicates captive contact.
- See page 6 for alternate body plating information.
- All items are available with other flange sizes and contact configurations.

• 7/16 connectors with 1" square flanges have lower maximum power rating than standard-flange connectors—contact factory for details.

Panel Plug Receptacles - Tab Contact

Figure 1
(1" square flange, interchangeable with type N standard flange size)

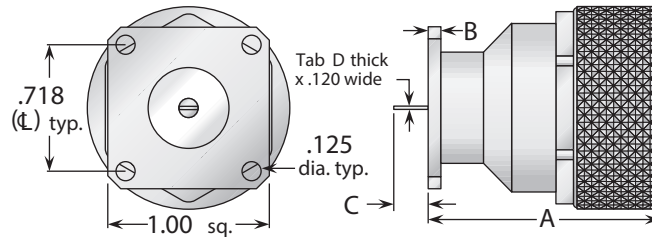

Figure	Dimensions				Mounting Figure	Plating		Delta P/N
	A	B	C	D		Body	Contact	
1	1.40	.080	.100	.005/.008	33	Silver	Gold (C)	9259000A331-000

Panel Plug Receptacles - Slotted Contact

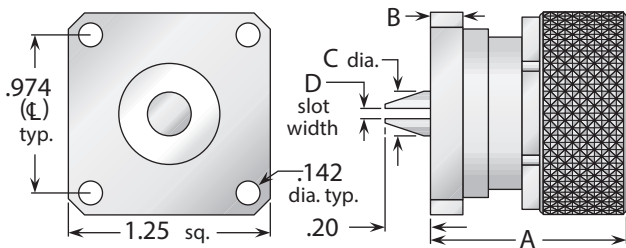

Figure 1
(Standard flange)

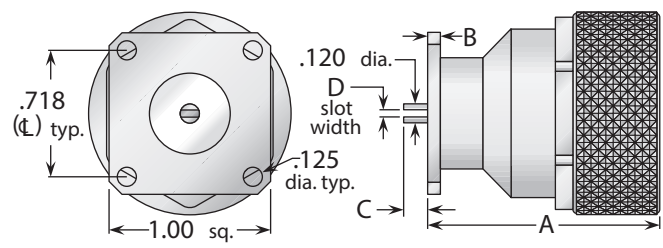

Figure 2
(1" square flange, interchangeable with type N standard flange size)

Figure	Dimensions				Mounting Figure	Plating		Delta P/N
	A	B	C	D		Body	Contact	
1	1.21	.197	.276	.095	See above	Silver	Silver (C)	9223000A911-002
2	1.40	.080	.050	.013/.017	33	Silver	Gold (C)	9259000A331-006

Panel Plug Receptacles - Post Contact

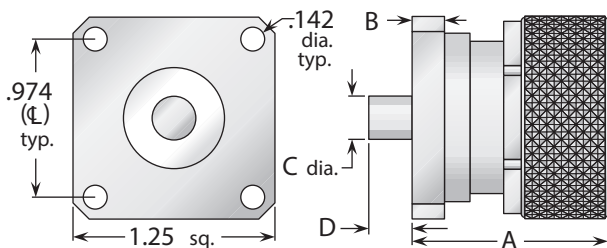

Figure 1
(Standard flange)

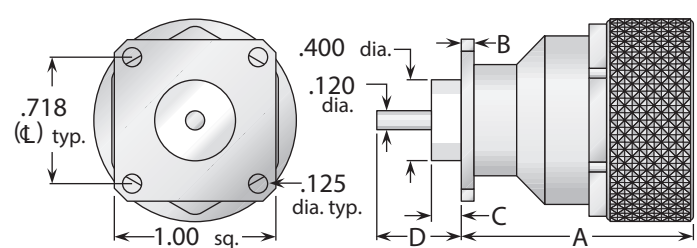

Figure 2
(1" square flange, interchangeable with type N standard flange size)

Figure	Dimensions				Mounting Figure	Plating		Delta P/N
	A	B	C	D		Body	Contact	
1	1.21	.197	.274	.250	See above	Silver	Silver (C)	9259000A911-004
2	1.40	.080	.325	.500	33	Silver	Silver (C)	9259000A331-007
2	1.40	.080	.000	.562	33	Silver	Gold (C)	9259000A331-001

- (C) in contact plating column indicates captive contact.
- See page 6 for alternate body plating information.
- All items are available with other flange sizes and contact configurations.

• 7/16 connectors with 1" square flanges have lower maximum power rating than standard-flange connectors—contact factory for details.

Bulkhead Mounted Jack-Jack Adapter (Connects Two Plugs)

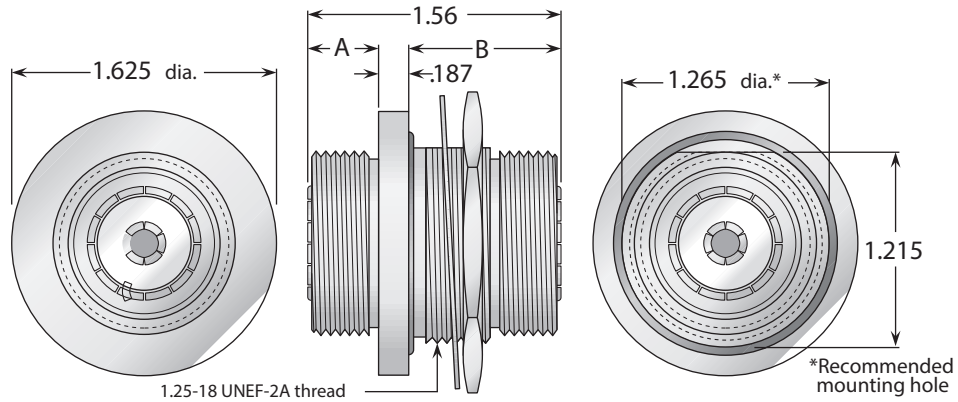

Figure 1

Figure	Dimensions		Max. Panel	Mounting Figure	Plating		Delta P/N
	A	B			Body	Contact	
1	.440	.933	.350	See above	Silver	Silver (C)	9226000A911-001

7/16 To N Adapters

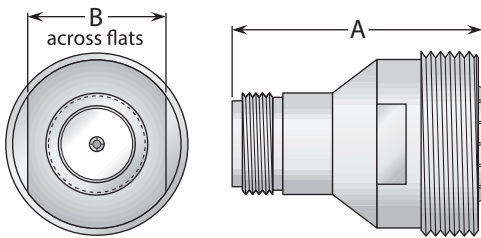

Figure 1
(7/16 jack-N jack)

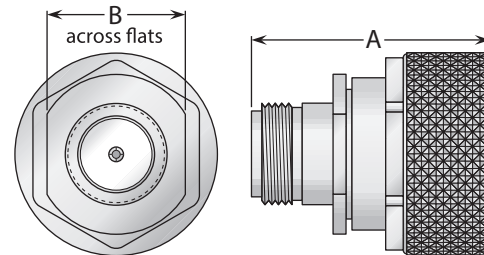

Figure 2
(7/16 plug-N jack)

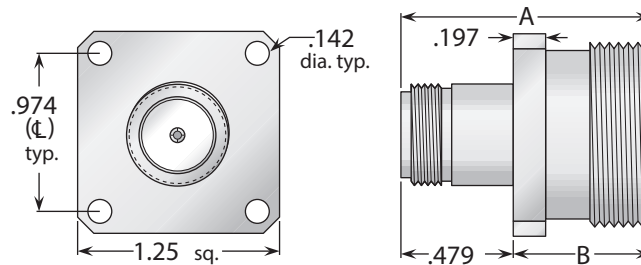

Figure 3
(7/16 jack-N jack, panel mounted)

Figure	Dimensions		Plating		Delta P/N
	A	B	Body	Contact	
1	1.33	.937	Silver	Gold (C)	2228000A001-029
2	1.41	.875	Silver	Gold (C)	2234000A001-122
3	1.33	.850	Silver	Silver (C)	2225000A911-009

• (C) in contact plating column indicates captive contact. • See page 6 for alternate body plating information.

Adapter Finder

Adapters in this chart and on the following pages are listed in alphabetic order—to find an adapter that connects a TNC plug to a BNC jack, look under “BNC plug to TNC jack.”

Left end:	Right end:	Delta P/N	Page	Left end:	Right end:	Delta P/N	Page	
7/16 Plug	N Jack	2234000A001-122	175	G874	Any	see pages	41-42	
7/16 Jack	N Jack	2228000A001-029	175	HN Jack	N Jack	2228000N001-022	180	
	N Jack	2225000A911-009	175		N Jack	2225000N401-000	180	
BNC Jack	C Plug	UG-636A/U	177		N Plug	UG-1108/U	180	
	HN Plug	UG-309/U	177	HN Plug	N Jack	2234000N001-070	180	
	N Jack	2225000N331-006	177		N Plug	UG-1107/U	180	
	N Jack	UG-606/U	177		TNC Plug	2234000N004-011	180	
	N Jack	M55339/25-00606	177	LC Jack	N Plug	2234000N000-078	180	
	N Jack	M55339/01-00001	177	N Jack	SC Jack	2228000N000-012	181	
	N Plug	UG-201A/U	177		SC Plug	2234000N000-055	181	
	N Plug	M55339/20-00201	177		SMA Jack	2225000N331-005	181	
	SC Jack	2228000N000-009	177		SMA Jack	2226000N721-001	181	
	SC Plug	2234000N001-100	177		SMA Jack	2228000N00M-010	181	
	TNC Jack	2234000N000-008	177		SMA Plug	2234000N331-003	181	
	TNC Plug	2234000N000-006	177		TNC Jack	2225000N331-008	181	
	UHF Plug	UG-273/U	177		TNC Jack	2228000N001-002	181	
	BNC Plug	C Jack	UG-635/U		178	TNC Plug	2234000N001-009	181
		HN Jack	2234000N001-010		178	UHF Plug	UG-83B/U	181
HN Plug		2234000N004-010	178	N Plug	SC Jack	2234000N000-065	182	
N Jack		UG-349B/U	178		SC Plug	2227000N000-003	182	
N Jack		M55339/49-00349	178		SMA Plug	2234000N00M-039	182	
N Jack		UG-335A/U	178		SMA Jack	2234000N001-004	182	
N Jack		M55339/24-00335	178		TNC Jack	2234000N001-007	182	
N Plug		UG-1034/U	178		TNC Plug	2234000N000-012	182	
N Plug		M55339/18-01034	178		UHF Jack	UG-146A/U	182	
SC Plug		2227000N000-004	178		UHF Plug	2227000N000-016	182	
TNC Jack		2234000N000-009	178		QDS series	Any	See page	96
TNC Plug		2234000N000-007	178		SMA Jack	SMB Jack	2234000N001-078	183
UHF Jack		UG-255A/U	178	SMB Plug		2228000N001-015	183	
C Jack		HN Plug	2234000N001-051	179		SMC Jack	2234000N001-121	183
		N Plug	UG-564/U	179		SMC Plug	2234000N001-077	183
	TNC Plug	2234000N000-010	179	TNC Jack		2225000K071-002	183	
	UHF Plug	UG-637/U	179	SMA Plug	SMB Jack	2234000N001-082	183	
C Plug	HN Jack	UG-703A/U	179		SMB Plug	2234000N000-069	183	
	N Jack	UG-565A/U	179		SMC Jack	2234000N001-120	183	
	TNC Jack	2234000N000-011	179		SMC Plug	2234000N001-081	183	

Adapters - BNC Jack To Other Series

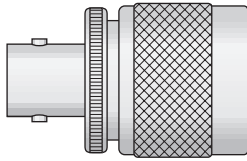

Figure 1
(BNC jack-C plug)

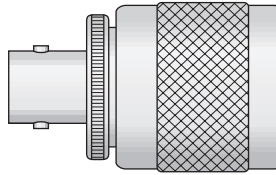

Figure 2
(BNC jack-HN plug)

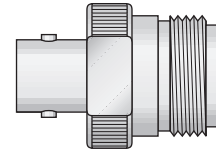

Figure 3
(BNC jack-N jack)

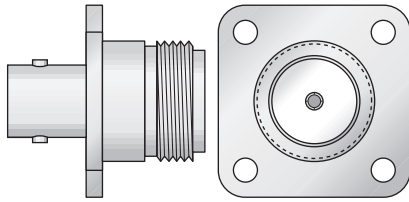

Figure 4
(BNC jack-N jack)

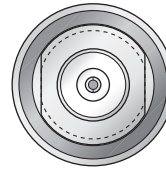

Figure 5
(BNC jack-N jack)

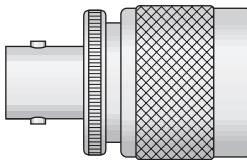
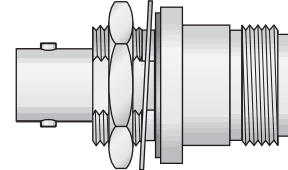

Figure 6
(BNC jack-N plug)

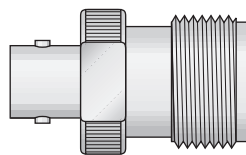

Figure 7
(BNC jack-SC jack)

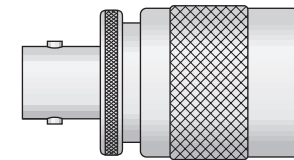

Figure 8
(BNC jack-SC plug)



Figure 9
(BNC jack-TNC jack)

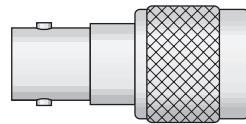

Figure 10
(BNC jack-TNC plug)

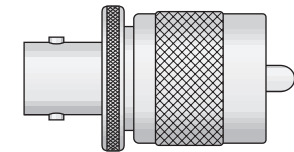

Figure 11
(BNC jack-UHF plug)

Figure	Adapter Ends	Length	Mounting Figure	Plating		Delta P/N
				Body	Contact	
1	BNC jack-C plug	1.23	None	Nickel	Silver (C)	UG-636A/U
2	BNC jack-HN plug	1.50	None	Nickel	Silver (C)	UG-309/U
3	BNC jack-N jack	1.13	None	Silver	Gold (C)	M55339/01-00001
4	BNC jack-N jack	1.39	33	Nickel	Silver (C)	2225000N331-006
5	BNC jack-N jack	1.75	72	Nickel	Silver (C)	UG-606/U
5	BNC jack-N jack	1.75	72	Silver	Gold (C)	M55339/25-00606
6	BNC jack-N plug	1.31	None	Nickel	Silver (C)	UG-201A/U
6	BNC jack-N plug	1.31	None	Silver	Gold (C)	M55339/20-00201
7	BNC jack-SC jack	1.23	None	Nickel	Gold (C)	2228000N000-009
8	BNC jack-SC plug	1.45	None	Nickel	Silver (C)	2234000N001-100
9	BNC jack-TNC jack	1.28	None	Nickel	Silver (C)	2234000N000-008
10	BNC jack-TNC plug	1.23	None	Nickel	Gold (C)	2234000N000-006
11	BNC jack-UHF plug	1.34	None	Nickel	Silver (C)	UG-273/U

See page 208 for mounting dimensions. • (C) in contact plating column indicates captive contact.
See page 6 for alternate body plating information.

Adapters - BNC Plug To Other Series

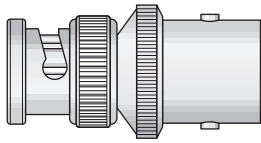

Figure 1
(BNC plug-C jack)

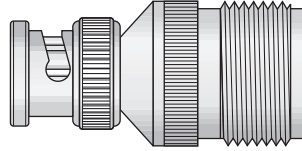

Figure 2
(BNC plug-HN jack)

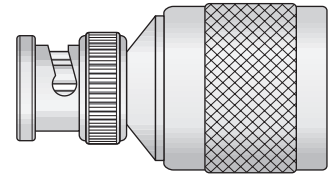

Figure 3
(BNC plug-HN plug)

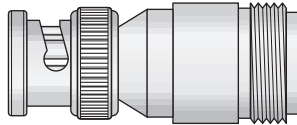

Figure 4
(BNC plug-N jack)

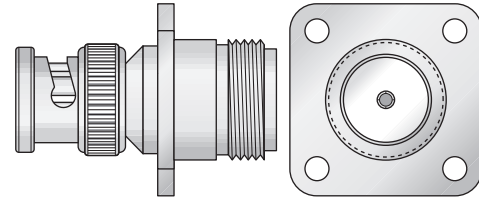

Figure 5
(BNC plug-N jack)

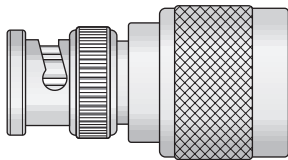

Figure 6
(BNC plug-N plug)

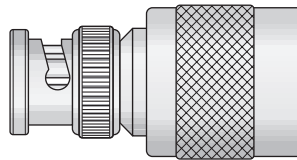

Figure 7
(BNC plug-SC plug)

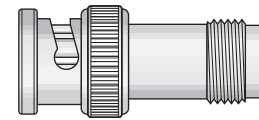

Figure 8
(BNC plug-TNC jack)

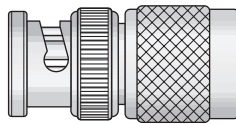

Figure 9
(BNC plug-TNC plug)

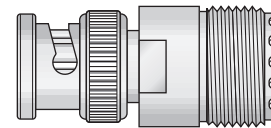

Figure 10
(BNC plug-UHF jack)

Figure	Adapter Ends	Length	Mounting Figure	Plating		Delta P/N
				Body	Contact	
1	BNC plug-C jack	1.27	None	Nickel	Silver (C)	UG-635/U
2	BNC plug-HN jack	1.58	None	Nickel	Silver (C)	2234000N001-010
3	BNC plug-HN plug	1.58	None	Nickel	Silver (C)	2234000N004-010
4	BNC plug-N jack	1.47	None	Nickel	Silver (C)	UG-349B/U
4	BNC plug-N jack	1.47	None	Silver	Gold (C)	M55339/49-00349
5	BNC plug-N jack	1.47	33	Nickel	Silver (C)	UG-335A/U
5	BNC plug-N jack	1.47	33	Silver	Gold (C)	M55339/24-00335
6	BNC plug-N plug	1.48	None	Nickel	Silver (C)	UG-1034/U
6	BNC plug-N plug	1.48	None	Silver	Gold (C)	M55339/18-01034
7	BNC plug-SC plug	1.50	None	Nickel	Silver (C)	2227000N000-004
8	BNC plug-TNC jack	1.25	None	Nickel	Gold (C)	2234000N000-009
9	BNC plug-TNC plug	1.19	None	Nickel	Silver (C)	2234000N000-007
10	BNC plug-UHF jack	1.33	None	Nickel	Silver (C)	UG-255A/U

See page 208 for mounting dimensions. • (C) in contact plating column indicates captive contact.
 See page 6 for alternate body plating information.

Adapters - C Jack To Other Series

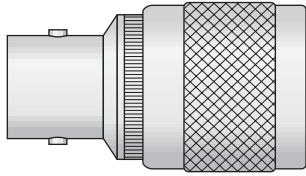

Figure 1
(C jack-HN plug)

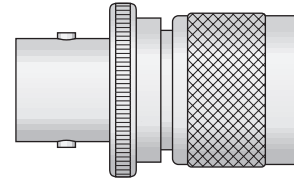

Figure 2
(C jack-N plug)

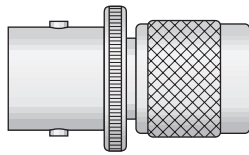

Figure 3
(C jack-TNC plug)

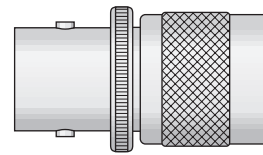

Figure 4
(C jack-UHF plug)

Figure	Adapter Ends	Length	Mounting Figure	Plating		Delta P/N
				Body	Contact	
1	C jack-HN plug	1.50	None	Nickel	Silver (C)	2234000N001-051
2	C jack-N plug	1.42	None	Nickel	Silver (C)	UG-564/U
3	C jack-TNC plug	1.23	None	Nickel	Silver (C)	2234000N000-010
4	C jack-UHF plug	1.38	None	Nickel	Silver (C)	UG-637/U

Adapters - C Plug To Other Series

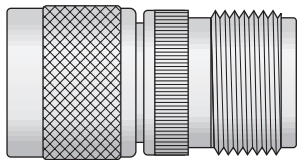

Figure 1
(C plug-HN jack)

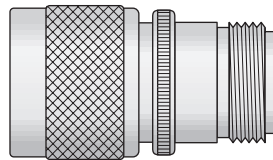

Figure 2
(C plug-N jack)

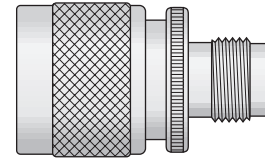

Figure 3
(C plug-TNC jack)

Figure	Adapter Ends	Length	Mounting Figure	Plating		Delta P/N
				Body	Contact	
1	C plug-HN jack	1.46	None	Nickel	Silver (C)	UG-703A/U
2	C plug-N jack	1.53	None	Nickel	Silver (C)	UG-565A/U
3	C plug-TNC jack	1.23	None	Nickel	Silver (C)	2234000N000-011

(C) in contact plating column indicates captive contact.
See page 6 for alternate body plating information.

Adapters - HN Jack To Other Series

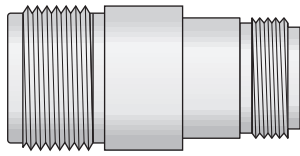

Figure 1
(HN jack-N jack)

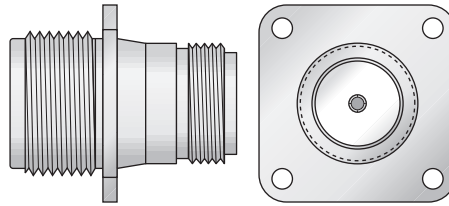

Figure 2
(HN jack-N jack)

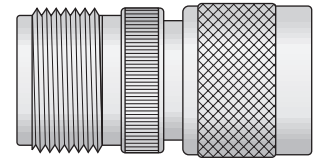

Figure 3
(HN jack-N plug)

Figure	Adapter Ends	Length	Mounting Figure	Plating		Delta P/N
				Body	Contact	
1	HN jack-N jack	1.65	None	Nickel	Silver (C)	2228000N001-022
2	HN jack-N jack	1.83	40	Nickel	Silver (C)	2225000N401-000
3	HN jack-N plug	1.56	None	Nickel	Silver (C)	UG-1108/U

Adapters - HN Plug To Other Series

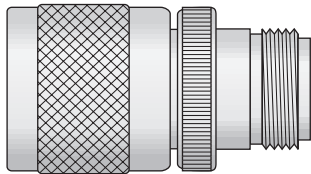

Figure 1
(HN plug-N jack)

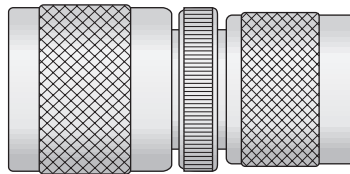

Figure 2
(HN plug-N plug)

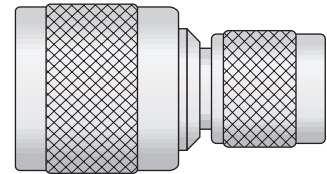

Figure 3
(HN plug-TNC plug)

Figure	Adapter Ends	Length	Mounting Figure	Plating		Delta P/N
				Body	Contact	
1	HN plug-N jack	1.56	None	Nickel	Silver (C)	2234000N001-070
2	HN plug-N plug	1.83	None	Nickel	Silver (C)	UG-1107/U
3	HN plug-TNC plug	1.56	None	Nickel	Silver (C)	2234000N004-011

Adapters - LC Jack To Other Series

Figure 1
(LC jack-N plug)

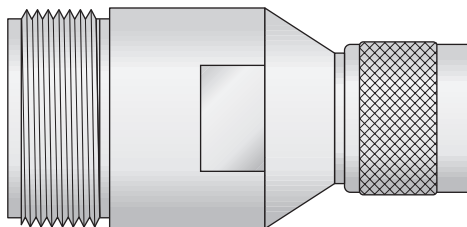

Figure	Adapter Ends	Length	Mounting Figure	Plating		Delta P/N
				Body	Contact	
1	LC jack-N plug	2.39	None	Nickel	Silver (C)	2234000N000-078

- See page 208 for mounting dimensions.
- (C) in contact plating column indicates captive contact.
- See page 6 for alternate body plating information.

Adapters - N Jack To Other Series

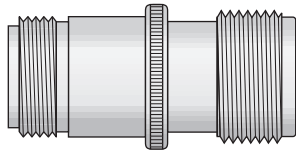

Figure 1
(N jack-SC jack)

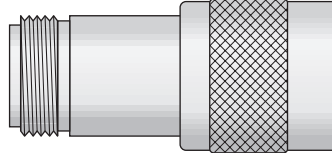

Figure 2
(N jack-SC plug)

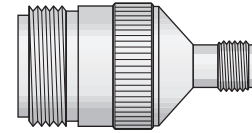

Figure 3
(N jack-SMA jack)

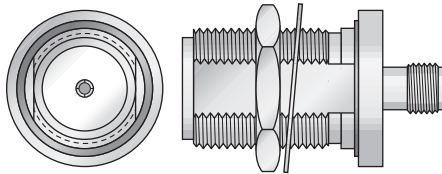

Figure 4
(N jack-SMA jack)

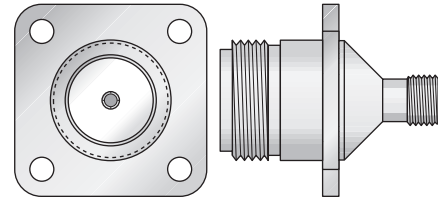

Figure 5
(N jack-SMA jack)

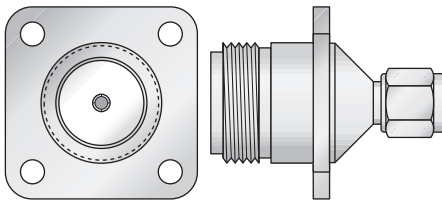

Figure 6
(N jack-SMA plug)

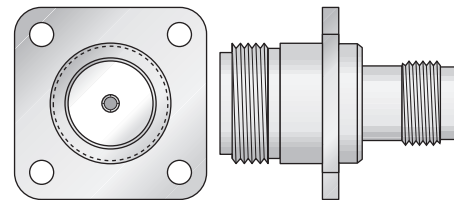

Figure 7
(N jack-TNC jack)

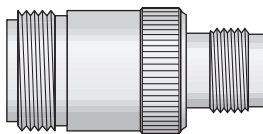

Figure 8
(N jack-TNC jack)

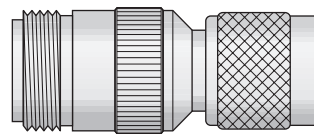

Figure 9
(N jack-TNC plug)

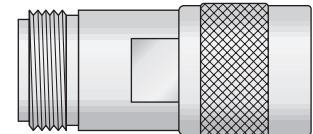

Figure 10
(N jack-UHF plug)

Figure	Adapter Ends	Length	Mounting Figure	Plating		Delta P/N
				Body	Contact	
1	N jack-SC jack	1.63	None	Nickel	Silver (C)	2228000N000-012
2	N jack-SC plug	1.53	None	Nickel	Silver (C)	2234000N000-055
3	N jack-SMA jack	1.24	None	Nickel	Gold (C)	2228000N00M-010
4	N jack-SMA jack	1.26	72	Nickel	Gold (C)	2226000N721-001
5	N jack-SMA jack	1.24	33	Nickel	Gold (C)	2225000N331-005
6	N jack-SMA plug	1.28	33	Nickel	Gold (C)	2234000N331-003
7	N jack-TNC jack	1.39	33	Nickel	Gold (C)	2225000N331-008
8	N jack-TNC jack	1.39	None	Nickel	Gold (C)	2228000N001-002
9	N jack-TNC plug	1.53	None	Nickel	Gold (C)	2234000N001-009
10	N jack-UHF plug	1.56	None	Nickel	Silver (C)	UG-83B/U

See page 208 for mounting dimensions. • (C) in contact plating column indicates captive contact.
 See page 6 for alternate body plating information.

Adapters - N Jack To Other Series

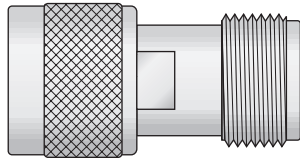

Figure 1
(N plug-SC jack)

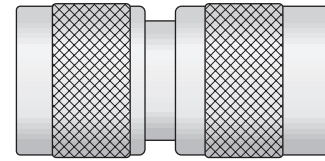

Figure 2
(N plug-SC plug)

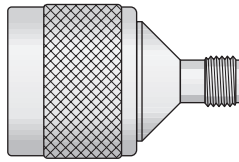

Figure 3
(N plug-SMA jack)

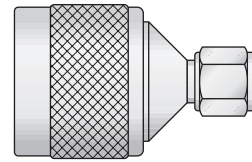

Figure 4
(N plug-SMA plug)

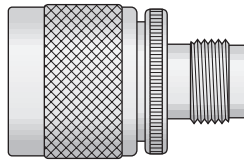

Figure 5
(N plug-TNC jack)

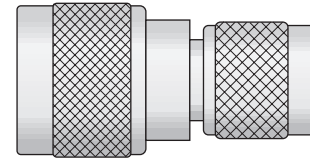

Figure 6
(N plug-TNC plug)

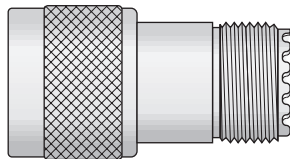

Figure 7
(N plug-UHF jack)

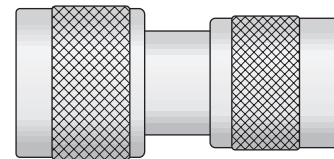

Figure 8
(N plug-UHF plug)

Figure	Adapter Ends	Length	Mounting Figure	Plating		Delta P/N
				Body	Contact	
1	N plug-SC jack	1.38	None	Nickel	Silver (C)	2234000N000-065
2	N plug-SC plug	1.70	None	Nickel	Silver (C)	2227000N000-003
3	N plug-SMA jack	1.23	None	Nickel	Gold (C)	2234000N001-004
4	N plug-SMA plug	1.28	None	Nickel	Gold (C)	2234000N00M-039
5	N plug-TNC jack	1.31	None	Nickel	Silver (C)	2234000N001-007
6	N plug-TNC plug	1.44	None	Nickel	Silver (C)	2234000N000-012
7	N plug-UHF jack	1.50	None	Nickel	Silver (C)	UG-146A/U
8	N plug-UHF plug	1.59	None	Nickel	Silver (C)	2227000N000-016

(C) in contact plating column indicates captive contact.
See page 6 for alternate body plating information.

Adapters - SMA Jack To Other Series

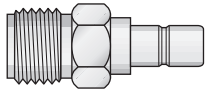

Figure 1
(SMA jack-SMB jack)

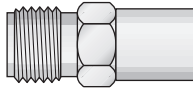

Figure 2
(SMA jack-SMB plug)

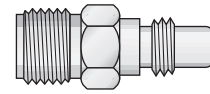

Figure 3
(SMA jack-SMC jack)

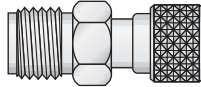

Figure 4
(SMA jack-SMC plug)

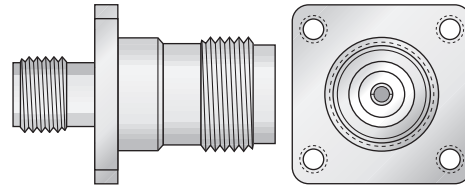

Figure 5
(SMA jack-TNC jack)

Figure	Adapter Ends	Length	Mounting Figure	Plating		Delta P/N
				Body	Contact	
1	SMA jack-SMB jack	.650	None	Nickel	Gold (C)	2234000N001-078
2	SMA jack-SMB plug	.640	None	Nickel	Gold (C)	2228000N001-015
3	SMA jack-SMC jack	.650	None	Nickel	Gold (C)	2234000N001-121
4	SMA jack-SMC plug	.690	None	Nickel	Gold (C)	2234000N001-077
5	SMA jack-TNC jack	1.00	07	PSS*	Gold (C)	2225000K071-002

* Passivated stainless steel.

Adapters - SMA Plug To Other Series

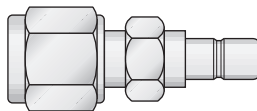

Figure 1
(SMA plug-SMB jack)

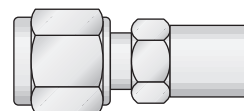

Figure 2
(SMA plug-SMB plug)

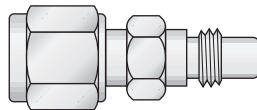

Figure 3
(SMA plug-SMC jack)

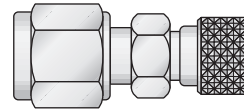

Figure 4
(SMA plug-SMC plug)

Figure	Adapter Ends	Length	Mounting Figure	Plating		Delta P/N
				Body	Contact	
1	SMA plug-SMB jack	.810	None	Nickel	Gold (C)	2234000N001-082
2	SMA plug-SMB plug	.880	None	Nickel	Gold (C)	2234000N000-069
3	SMA plug-SMC jack	.810	None	Nickel	Gold (C)	2234000N001-120
4	SMA plug-SMC plug	.820	None	Nickel	Gold (C)	2234000N001-081

- See page 208 for mounting dimensions.
- (C) in contact plating column indicates captive contact.
- See page 6 for alternate body plating information.



DELTA
Electronics Mfg. Corp.



MIL-PRF-39012

QPL Connectors

MIL-PRF-55339

QPL Adapters

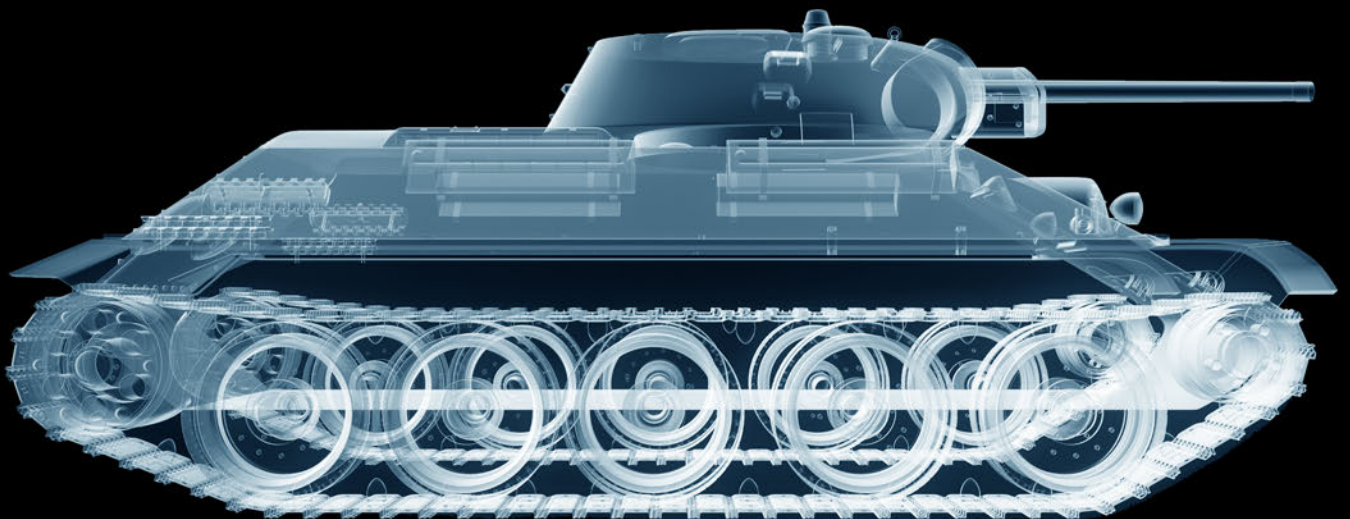

Experience The Delta Difference.



“Our Troops Depend On Delta.”



MIL-PRF-39012 & MIL-PRF-55339

M39012 Categories and Cable Groups

MIL-PRF-39012 QPL cable connectors are divided into categories which define the characteristics of their cable assembly method, and in some cases the actual assembly method:

Category A: Field-serviceable, with no special tools required for assembly. Our Category A connectors in series BNC, N, and TNC are standard military-clamp types; Category A connectors in SMA series are solder type.

Category B: Special tools may be required for assembly. Our Category B connectors in N series are crimp types which use standard, commercially-available crimp tools.

Category C: Crimp-type connectors which can be assembled with specified tools and die sizes.

Category D: Crimp-type connectors which can be assembled with specified tools and die sizes, and also have defined sizes for crimp sleeves, contacts, and other parts. Category D connectors have crimpable center contacts.

MIL-PRF-39012 Cable Groups

Group		Cables (M17/)
I		93-178,169-00001
II	IIA	113-RG316, 119-RG174, 173-00001, 172-00001, 196-00001
	IIB	94-RG179
III		152-00001
IV		54-RG122, 157-00001, 187-00001, 198-00001
V		95-RG180
VI	VIA	28-RG58, 111-RG303, 155-00001, 170-00001, 183-00001, 197-00001
	VIB	60-RG142, 84-RG223, 128-RG400, 158-00001, 167-00001, 175-00001, 194-00001, 200-00001
VII	VIIA	29-RG58, 30-RG62, 90-RG71, 97-RG210, 110-RG302, 184-00001, 185-00001
	VIIIB	90-RG71, 195-00001
VIII		2-RG6, 73-RG212, 112-RG304, 162-00001, 171-00001, 180-00001, 188-00001, 199-00001
X	XA	65-RG165, 74-RG213, 159-00001, 163-00001, 189-00001
	XB	75-RG214, 86-00001, 127-RG393, 164-00001, 174-00001, 190-00001
	XC	6-RG11, 62-RG144, 181-00001
	XD	77-RG216, 191-00001
XI		74-RG215, 189-00002
XII		78-RG217, 165-00001, 192-00001

MIL-PRF-39012 Cable Group Finder

Cable M17/	Category		Cable M17/	Category		Cable M17/	Category		Cable M17/	Category	
	A	B, C, D		A	B, C, D		A	B, C, D		A	B, C, D
2-RG6	VIII	VIII	90-RG71	VII	VIIIB	159-00001	X	XA	185-00001	VII	VIIA
6-RG11	X	XC	93-RG178	I	I	162-00001	VIII	VIII	187-00001	IV	IV
28-RG58	VI	VIA	94-RG179	II	IIB	163-00001	X	XA	188-00001	VIII	VIII
29-RG59	VII	VIIA	95-RG180	V	V	164-00001	X	XB	189-00001	X	XA
30-RG62	VII	VIIA	97-RG210	VII	VIIA	165-00001	XII	XII	189-00002	XI	—
54-RG122	IV	IV	110-RG302	VII	VIIA	167-00001	VI	VIB	190-00001	X	XB
60-RG142	VI	VIB	111-RG303	VI	VIA	169-00001	I	I	191-00001	X	XD
62-RG144	X	XC	112-RG304	VIII	VIII	170-00001	VI	VIA	192-00001	XII	XII
65-RG165	X	XA	113-RG316	II	IIA	171-00001	VIII	VIII	194-00001	VI	VIB
73-RG212	VIII	VIII	119-RG174	II	IIA	172-00001	II	IIA	196-00001	II	IIA
74-RG213	X	XA	127-RG393	X	XB	173-00001	II	IIA	197-00001	VI	VIA
74-RG215	XI	—	128-RG400	VI	VIB	174-00001	X	XB	198-00001	IV	IV
75-RG214	X	XB	133-RG316	II	IIA	175-00001	VI	VIB	199-00001	VIII	VIII
77-RG216	X	XD	152-00001	III	III	180-00001	VIII	VIII	200-00001	VI	VIB
78-RG217	XII	XII	155-00001	VI	VIA	181-00001	X	XC			
84-RG223	VI	VIB	157-00001	IV	IV	183-00001	VI	VIA			
86-00001	X	XB	158-00001	VI	VIB	184-00001	VII	VIIA			

M39012/16 - BNC Straight Plug

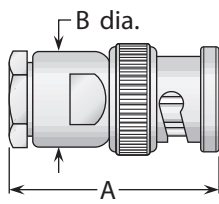

Figure 1

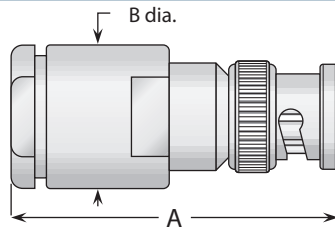

Figure 2

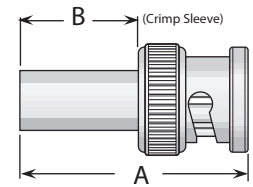

Figure 3

M39012 P/N	Category	Cable Group	Figure	Dimensions		Plating		Assembly Procedure/ Trim Code
				A	B	Body	Contact	
M39012/16-0013	C	VIA	3	1.13	.500	Silver	Gold (C)	B / 19
M39012/16-0014	C	VIB	3	1.13	.500	Silver	Gold (C)	B / 19
M39012/16-0015	C	VIIA	3	1.10	.500	Silver	Gold (C)	B / 19
M39012/16-0016	C	IV	3	1.13	.500	Silver	Gold (C)	B / 19
M39012/16-0017	C	VIIB	3	1.13	.500	Silver	Gold (C)	B / 19
M39012/16-0101	A	VI	1	1.06	.500	Silver	Gold (C)	A / 17
M39012/16-0102	A	VII	1	1.06	.500	Silver	Gold (C)	A / 17
M39012/16-0103	A	IV	1	1.06	.500	Silver	Gold (C)	A / 17
M39012/16-0111	A	VI	1	1.06	.500	Silver	Gold (C)	A / 17
M39012/16-0118	A	VII	1	1.06	.500	Silver	Gold (C)	A / 17
M39012/16-0220	A	II	1	1.06	.500	Silver	Gold (C)	A / 37
M39012/16-0222	A	II	3	.920	.307	Silver	Gold (C)	B / 19
M39012/16-0225	A	X	2	1.66	.750	Silver	Gold (C)	A / 01

M39012/17 - BNC Straight Jack & M39012/18 - BNC Panel Jack

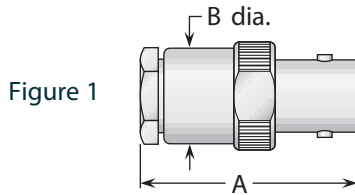
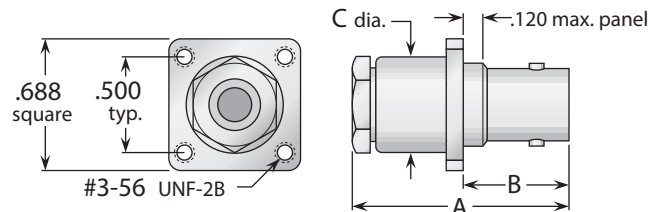

Figure 1

Figure 2



M39012 P/N	Category	Cable Group	Figure	Dimensions		Plating		Assembly Procedure/ Trim Code
				A	B	Body	Contact	
M39012/17-0101	A	VI	1	1.16	.500	Silver	Gold (C)	A / 17
M39012/17-0102	A	VII	1	1.16	.500	Silver	Gold (C)	A / 17
M39012/17-0103	A	IV	1	1.16	.500	Silver	Gold (C)	A / 17
M39012/17-0111	A	VI	1	1.16	.500	Silver	Gold (C)	A / 17
M39012/17-0118	A	VII	1	1.16	.500	Silver	Gold (C)	A / 17

M39012 P/N	Category	Cable Group	Figure	Dimensions			Plating		Assembly Procedure/ Trim Code
				A	B	C	Body	Contact	
M39012/18-0101	A	VII	2	1.16	.550	.500	Silver	Gold (C)	A / 17
M39012/18-0102	A	VI	2	1.16	.550	.500	Silver	Gold (C)	A / 17
M39012/18-0103	A	IV	2	1.16	.550	.500	Silver	Gold (C)	A / 17
M39012/18-0111	A	VI	2	1.16	.550	.500	Silver	Gold (C)	A / 17
M39012/18-0118	A	VII	2	1.16	.550	.500	Silver	Gold (C)	A / 17
M39012/18-0220	A	II	2	1.16	.550	.500	Silver	Gold (C)	A / 38

See page 186 for cable groups and category definitions. • Assembly procedures start on page 205. • (C) indicates captive contact.

M39012/19 - BNC Bulkhead Jack

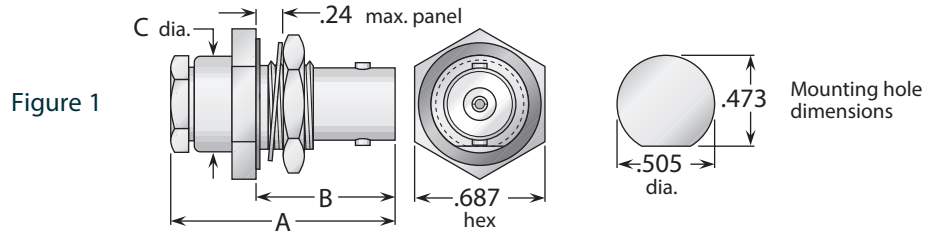

M39012 P/N	Category	Cable Group	Figure	Dimensions			Plating		Assembly Procedure/ Trim Code
				A	B	C	Body	Contact	
M39012/19-0101	A	VI	1	1.16	.810	.500	Silver	Gold (C)	A / 17
M39012/19-0102	A	VII	1	1.16	.810	.500	Silver	Gold (C)	A / 17
M39012/19-0110	A	IV	1	1.16	.810	.500	Silver	Gold (C)	A / 17
M39012/19-0111	A	VI	1	1.16	.810	.500	Silver	Gold (C)	A / 17
M39012/19-0118	A	VII	1	1.16	.810	.500	Silver	Gold (C)	A / 17
M39012/19-0220	A	II	1	1.16	.810	.500	Silver	Gold (C)	A / 17

M39012/20 - BNC Right Angle Plug

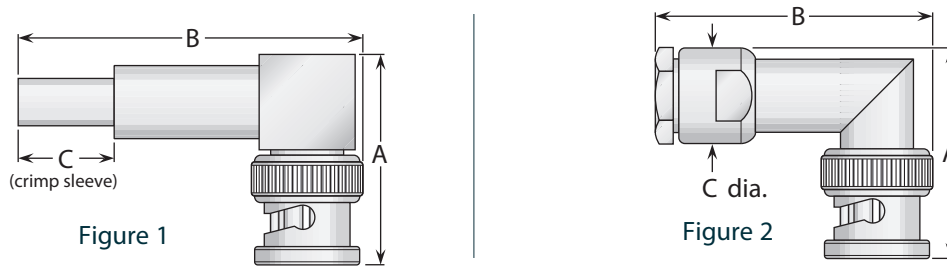

M39012 P/N	Category	Cable Group	Figure	Dimensions			Plating		Assembly Procedure/ Trim Code
				A	B	C	Body	Contact	
M39012/20-0006	C	VIA	1	1.07	1.63	.500	Silver	Gold (C)	B / 19
M39012/20-0007	C	VIB	1	1.07	1.63	.500	Silver	Gold (C)	B / 19
M39012/20-0101	A	VI	2	1.09	1.61	.500	Silver	Gold (C)	A / 17
M39012/20-0102	A	VII	2	1.09	1.61	.500	Silver	Gold (C)	A / 17
M39012/20-0108	A	VII	2	1.09	1.61	.500	Silver	Gold (C)	A / 17

M39012/21 - BNC Bulkhead Receptacle

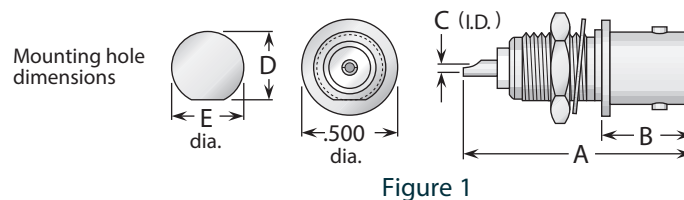

M39012 P/N	Figure	Dimensions					Maximum Panel	Plating	
		A	B	C	D	E		Body	Contact
M39012/21-0001	1	1.06	.490	.062	.410	.442	.130	Silver	Gold (C)
M39012/21-0002	1	1.19	.470	.062	.348	.380	.260	Silver	Gold (C)
M39012/21-0003	1	1.19	.470	.062	.410	.442	.260	Silver	Gold (C)

See page 186 for cable groups and category definitions. • Assembly procedures start on page 205. • (C) indicates captive contact.

M39012/22 - BNC Panel Receptacle

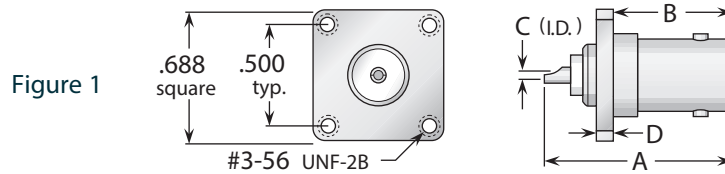

M39012 P/N	Figure	Dimensions				Maximum Panel	Plating	
		A	B	C	D		Body	Contact
M39012/22-0001	1	1.06	.63	.062	.090	.149	Silver	Gold (C)

M39012/24 - BNC Bulkhead Receptacle (Hermetically Sealed)

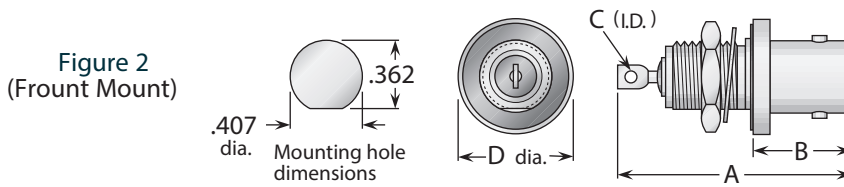
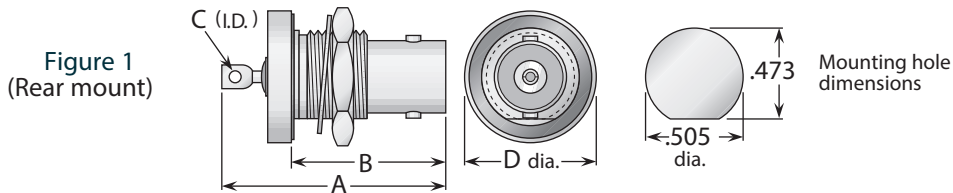

M39012 P/N	Figure	Dimensions				Maximum Panel	Plating	
		A	B	C	D		Body	Contact
M39012/24-0001	1	1.20	.83	.062	.687	2.60	Silver	Gold (C)
M39012/24-0002	2	1.20	.52	.062	.594	2.60	Silver	Gold (C)

M39012/25 - BNC Dust Caps

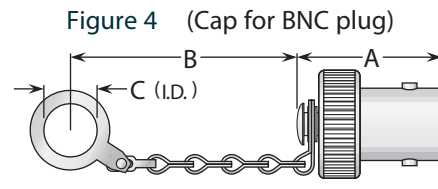
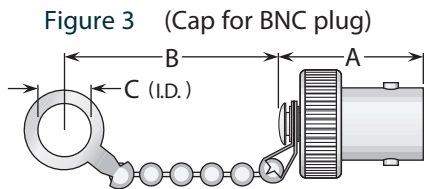
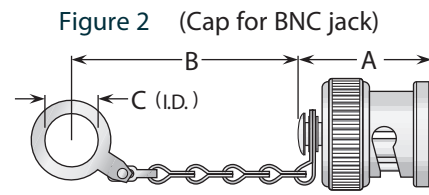
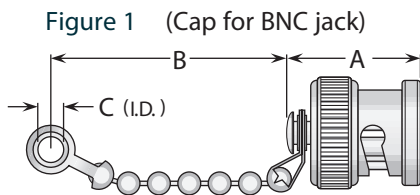

M39012 P/N	Figure	Dimensions			Chain Type	Plating	
		A	B	C		Body	Contact
M39012/25-0006	1	.670	2.25	.144	Bead	Silver	—
M39012/25-0007	2	.670	2.70	.520	Safety	Silver	—
M39012/25-0008	3	.690	3.25	.281	Bead	Silver	—
M39012/25-0009	4	.690	3.25	.281	Safety	Silver	—

(C) indicates captive contact.

M55339 - BNC Adapters Within Series

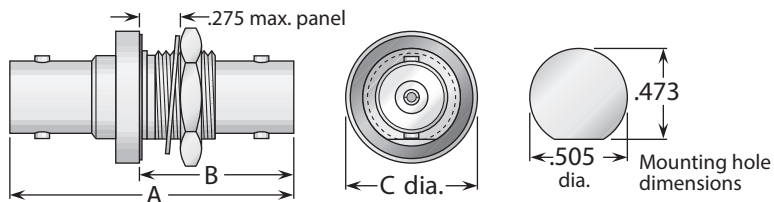

Figure 1 (Bulkhead mounted jack-jack, hermetically sealed)

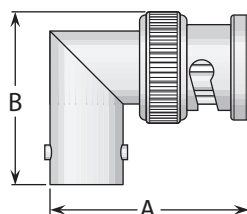

Figure 2
(Right angle jack-plug)

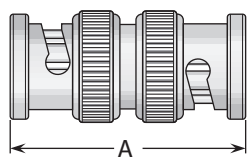

Figure 3 (Straight plug-plug)

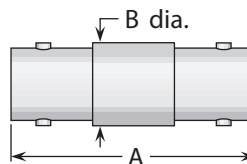

Figure 4 (Straight jack-jack)

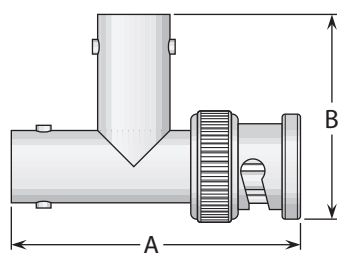

Figure 5 (Tee, jack-jack-plug)

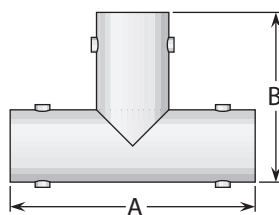

Figure 6 (Tee, jack-jack-jack)

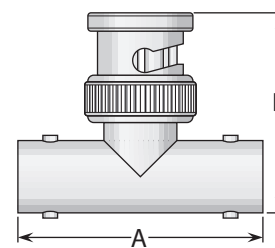
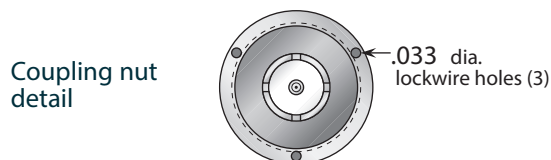
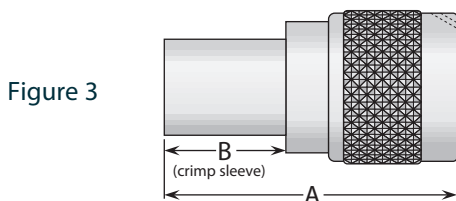
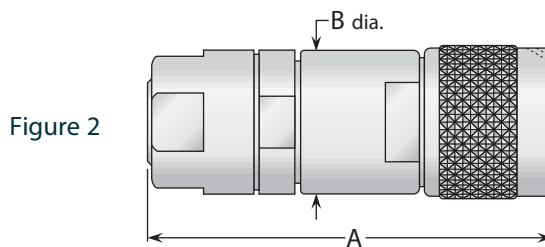
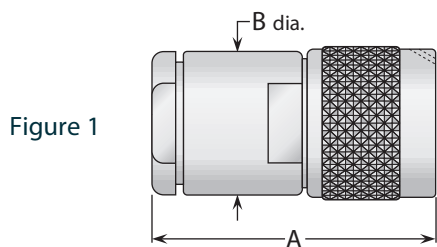

Figure 7 (Tee, jack-plug-jack)

M55339 P/N	Figure	Dimensions			Plating	
		A	B	C	Body	Contact
M55339/13-00492	1	1.53	.860	.690	Silver	Gold (C)
M55339/14-00306	2	1.06	.880	—	Silver	Gold (C)
M55339/15-00491	3	1.22	—	—	Silver	Gold (C)
M55339/16-00914	4	1.28	.440	—	Silver	Gold (C)
M55339/17-00001	5	1.50	1.06	—	Silver	Gold (C)
M55339/17-00002	6	1.28	.970	—	Silver	Gold (C)
M55339/17-00274	7	1.28	1.03	—	Silver	Gold (C)

(C) indicates captive contact.

M39012/01 - N Straight Plug



M39012 P/N	Category	Cable Group	Figure	Dimensions		Plating		Assembly Procedure/ Trim Code
				A	B	Body	Contact	
M39012/01-0005	A	X	1	1.50	.750	Silver	Gold (C)	A / 01
M39012/01-0015	A	XII	1	1.80	.880	Silver	Gold (C)	A / 01
M39012/01-0016	C	VIII	3	2.00	.781	Silver	Gold (C)	B / 03
M39012/01-0017	C	XA	3	2.00	.781	Silver	Gold (C)	B / 03
M39012/01-0018	C	XB	3	2.00	.781	Silver	Gold (C)	B / 03
M39012/01-0023	C	XC	3	2.00	.781	Silver	Gold (C)	B / 03
M39012/01-0024	C	XD	3	1.55	.781	Silver	Gold (C)	B / 03
M39012/01-0125	A	XI	2	2.42	.750	Silver	Gold (C)	Contact Factory
M39012/01-0501	D	XB	3	1.55	.600	Silver	Gold (C)	B / 03
M39012/01-0502	D	XA	3	1.55	.600	Silver	Gold (C)	B / 03
M39012/01-0503	D	VIB	3	1.45	.500	Silver	Gold (C)	B / 03
M39012/01B0007	B	XA	3	1.55	.600	Silver	Gold (C)	B / 03
M39012/01B0008	B	XB	3	1.55	.600	Silver	Gold (C)	B / 03

M39012/02 - N Straight Jack

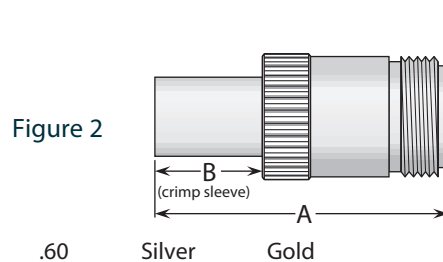
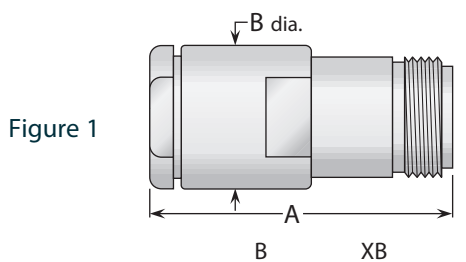

M39012 P/N	Category	Cable Group	Figure	Dimensions		Plating		Assembly Procedure/ Trim Code
				A	B	Body	Contact	
M39012/02-0003	A	X	1	1.67	.750	Silver	Gold (C)	A / 01
M39012/02-0101	A	VIII	1	1.67	.750	Silver	Gold (C)	A / 01
M39012/02-0501	D	XB	2	1.64	.600	Silver	Gold (C)	B / 03
M39012/02-0502	D	XA	2	1.64	.600	Silver	Gold (C)	B / 03
M39012/02-0503	D	VIB	2	1.54	.500	Silver	Gold (C)	B / 03
M39012/02B0008	B	XA	2	1.64	.600	Silver	Gold	B / 10
M39012/02B0009	B	XB	2	1.64	.600	Silver	Gold	B / 10

See next page for panel-mounted M39012/02 cable jacks.

See page 186 for cable groups and category definitions. • Assembly procedures start on page 205. • (C) indicates captive contact.

M39012/02 - N Panel Jack

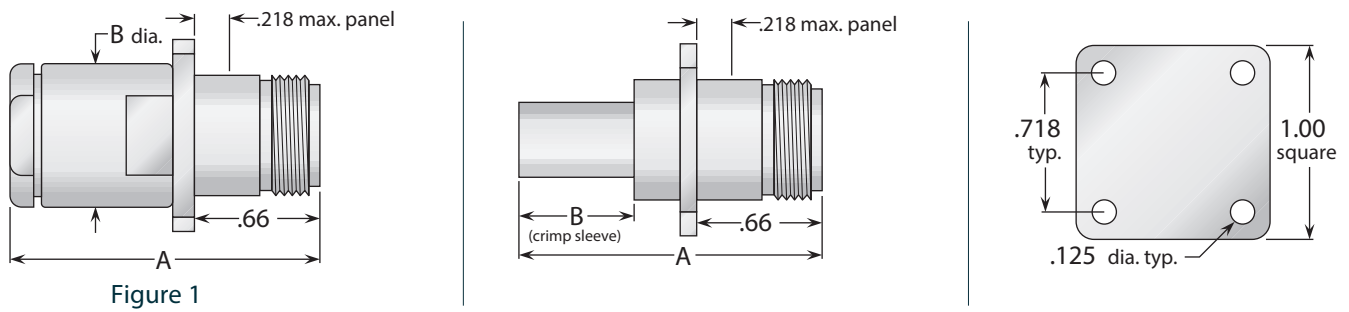

Figure 1

M39012 P/N	Category	Cable Group	Figure	Dimensions		Plating		Assembly Procedure/ Trim Code
				A	B	Body	Contact	
M39012/02-0006	A	X	1	1.67	.750	Silver	Gold (C)	A / 01
M39012/02-0104	A	VIII	1	1.67	.750	Silver	Gold (C)	A / 01
M39012/02-0511	D	XB	2	1.64	.600	Silver	Gold (C)	B / 03
M39012/02-0512	D	XA	2	1.64	.600	Silver	Gold (C)	B / 03
M39012/02-0513	D	VIB	2	1.54	.500	Silver	Gold (C)	B / 03

M39012/03 - N Bulkhead Jack

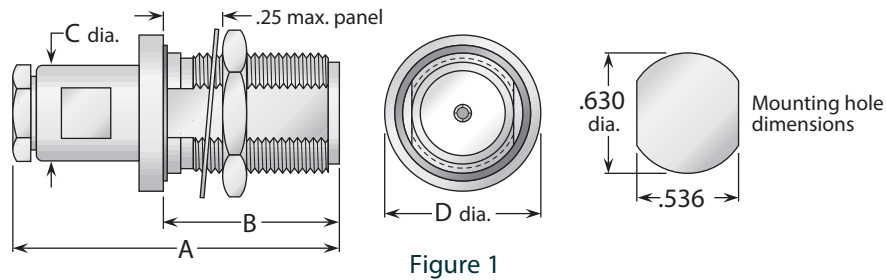

Figure 1

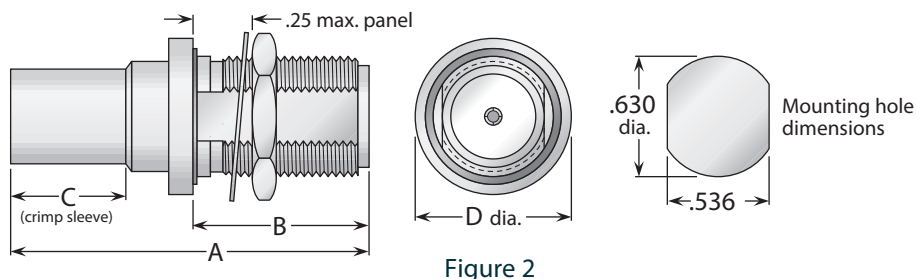

Figure 2

M39012 P/N	Category	Cable Group	Figure	Dimensions				Plating		Assembly Procedure/ Trim code
				A	B	C	D	Body	Contact	
M39012/03-0101	A	VIII	1	1.75	.920	.750	.900	Silver	Gold (C)	A / 01
M39012/03-0102	A	XII	1	1.90	.920	.880	.875	Silver	Gold (C)	A / 01
M39012/03-0501	D	XB	2	1.84	.920	.600	.875	Silver	Gold (C)	B / 03
M39012/03-0502	D	XA	2	1.84	.920	.600	.875	Silver	Gold (C)	B / 03
M39012/03-0503	D	VIB	2	1.74	.920	.500	.875	Silver	Gold (C)	B / 03
M39012/03B0004	B	XA	2	1.84	.920	.600	.875	Silver	Gold (C)	B / 03
M39012/03B0005	B	XB	2	1.84	.920	.600	.875	Silver	Gold (C)	B / 03

See page 186 for cable groups and category definitions. • Assembly procedures start on page 205. • (C) indicates captive contact.

M39012/04 - N Receptacles

Figure 1 (Bulkhead jack, hermetically sealed)

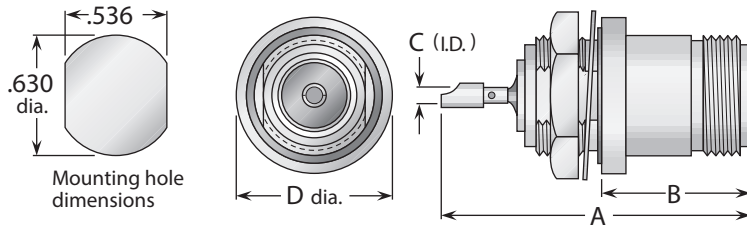
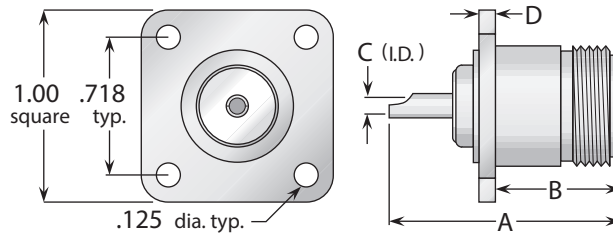

Figure 2 (Panel jack)



M39012 P/N	Figure	Dimensions				Maximum Panel	Plating	
		A	B	C	D		Body	Contact
M39012/04-0001	1	1.62	.707	.099	.812	.100	Silver	Gold (C)
M39012/04-0002	2	1.13	.660	.100	.080	.110	Silver	Gold (C)

M39012/05 - N Right Angle Plug

Figure 1

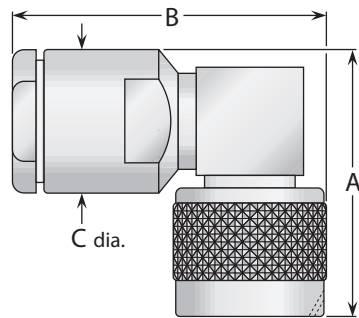

Coupling nut detail

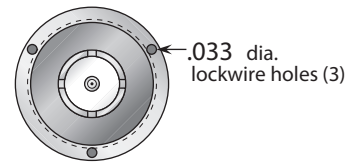

M39012 P/N	Category	Cable Group	Figure	Dimensions			Plating		Assembly Procedure/ Trim Code
				A	B	C	Body	Contact	
M39012/05-0101	A	X	1	1.36	1.66	.75	Silver	Gold (C)	A / 07

M39012/25 - N Dust Caps

Figure 1 (Cap for N jack)

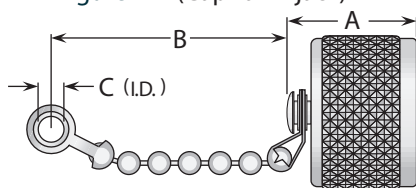
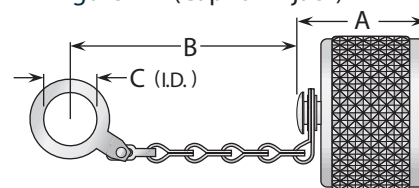

Figure 2 (Cap for N jack)



M39012 P/N	Figure	Dimensions			Chain Type	Plating	
		A	B	C		Body	Contact
M39012/25-0011	1	.56	2.50	.144	Bead	Silver	—
M39012/25-0012	2	.56	3.75	.635	Safety	Silver	—

See page 186 for cable groups and category definitions. • Assembly procedures start on page 205. • (C) indicates captive contact.

M55339 - N Adapters Within Series

Figure 1
(Right angle jack-plug)

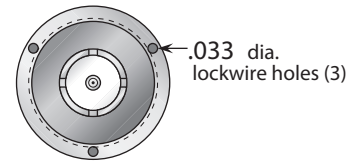
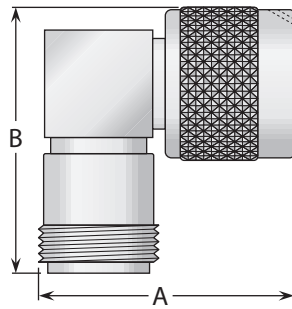

Coupling nut detail
(For figures 1, 3, and 4)

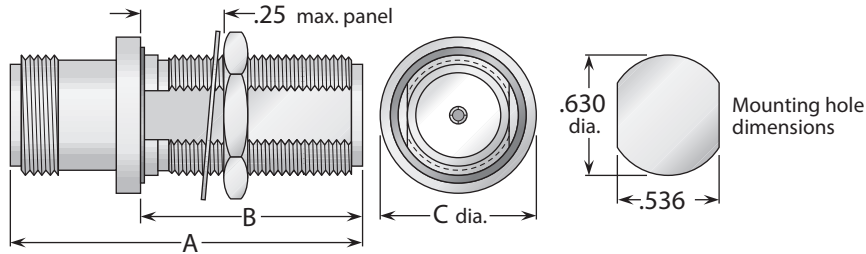

Figure 2 (Bulkhead mounted jack-jack, hermetically sealed)

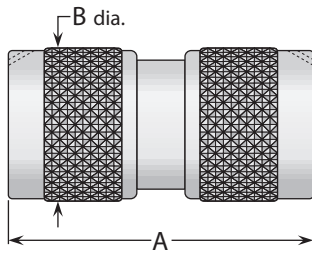

Figure 3
(Straight plug-plug)

Figure 4
(Tee, jack-plug-jack)

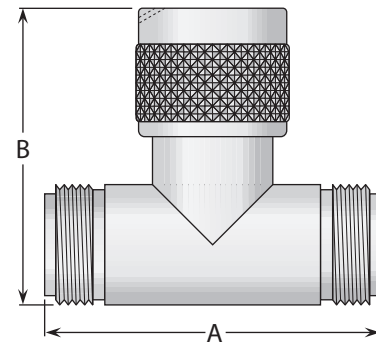

Figure 5
(Tee, jack-jack-jack)

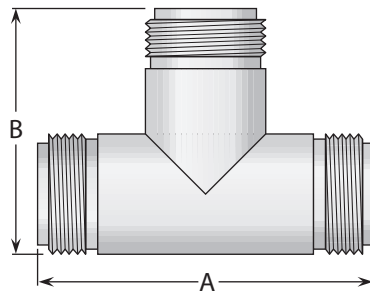
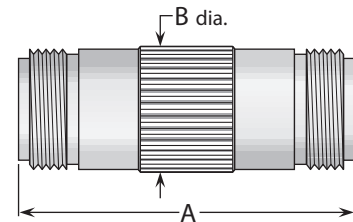

Figure 6 (Straight jack-jack)



M55339 P/N	Figure	Dimensions			Plating	
		A	B	C	Body	Contact
M55339/03-00027	1	1.30	1.38	—	Silver	Gold (C)
M55339/04-00030	2	1.54	.860	.875	Silver	Gold (C)
M55339/05-00057	3	1.59	—	—	Silver	Gold (C)
M55339/06-00001	4	1.75	1.47	—	Silver	Gold (C)
M55339/06-00028	5	1.75	1.22	—	Silver	Gold (C)
M55339/07-00029	6	1.75	.660	—	Silver	Gold (C)

(C) indicates captive contact.

M39012/25- SMA Dust Caps

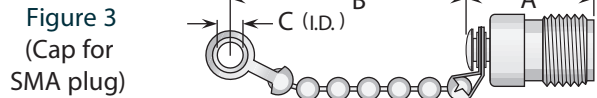
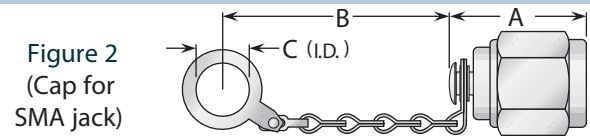
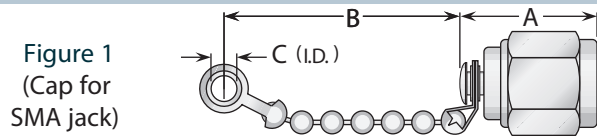

M39012 P/N	Figure	Dimensions			Chain Type	Plating	
		A	B	C		Body	Contact
M39012/25-3024	1	.50	2.25	.144	Bead	Passivated	—
M39012/25-3025	2	.50	3.25	.281	Safety	Passivated	—
M39012/25-3026	3	.50	3.25	.144	Bead	Passivated	—
M39012/25-3027	4	.50	3.25	.281	Safety	Passivated	—

M39012/55 - SMA Straight Plug

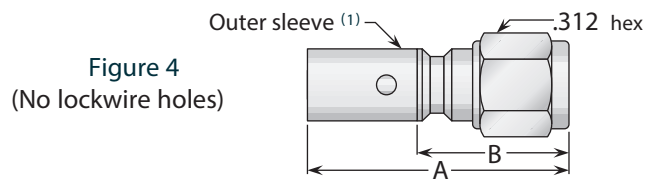
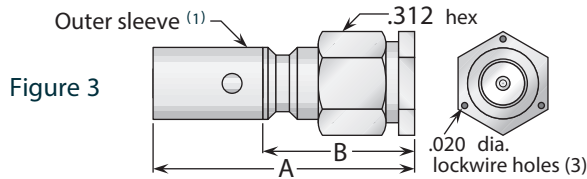
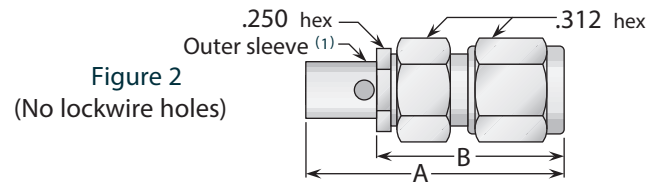
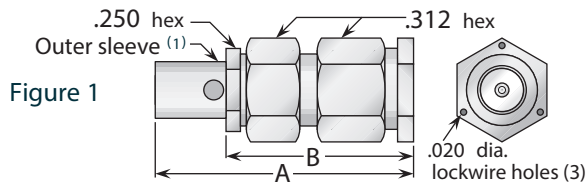

M39012 P/N	Category	Cable Group	Figure	Dimensions		Plating		Assembly Procedure/ Trim Code
				A	B	Body	Contact	
M39012/55-3006	A	I	1	.910	.670	Gold (2)	Gold (C)	M / 01
M39012/55-3007	A	II	1	.910	.670	Gold (2)	Gold (C)	M / 01
M39012/55-3008	A	IV	3	.940	.570	Gold (2)	Gold (C)	K / 12
M39012/55-3009	A	VI	3	.940	.570	Gold (2)	Gold (C)	K / 12
M39012/55-3025	C	I	1	.910	.670	Passivated	Gold (C)	M / 01
M39012/55-3026	C	IIA	1	.970	.670	Passivated	Gold (C)	M / 01
M39012/55-3027	C	IV	3	.940	.570	Passivated	Gold (C)	K / 12
M39012/55-3028	C	VIB	3	.950	.570	Passivated	Gold (C)	K / 12
M39012/55-3029	C	VIA	3	.970	.570	Passivated	Gold (C)	K / 12
M39012/55-3030	A	III	1	.910	.670	Gold (2)	Gold (C)	M / 01
M39012/55-3106	A	I	2	.910	.670	Gold (2)	Gold (C)	M / 01
M39012/55-3107	A	II	2	.910	.670	Gold (2)	Gold (C)	M / 01
M39012/55-3108	A	IV	4	.940	.570	Gold (2)	Gold (C)	K / 12
M39012/55-3109	A	VI	4	.940	.570	Gold (2)	Gold (C)	K / 12
M39012/55-3125	C	I	2	.910	.670	Passivated	Gold (C)	M / 01
M39012/55-3126	C	IIA	2	.970	.570	Passivated	Gold (C)	M / 01
M39012/55-3127	C	IV	4	.940	.570	Passivated	Gold (C)	K / 12
M39012/55-3128	C	VIB	4	.950	.570	Passivated	Gold (C)	K / 12
M39012/55-3129	C	VIA	4	.970	.570	Passivated	Gold (C)	K / 12
M39012/55-3130	A	III	2	.910	.670	Gold (2)	Gold (C)	M / 01

(1) Category A: Solder sleeve with access hole as shown; Category C: Crimp sleeve without access hole.
 (2) Coupling nut is passivated; body tail is gold plated for soldering of cable braid.

See page 186 for cable groups and category definitions. • Assembly procedures start on page 205. • (C) indicates captive contact.

M39012/55 - SMA Straight Plug - Continued

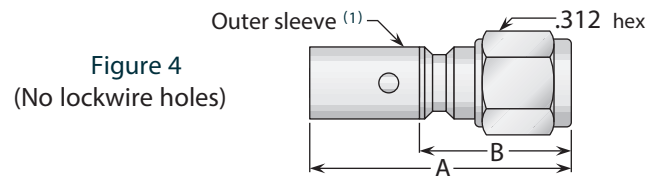
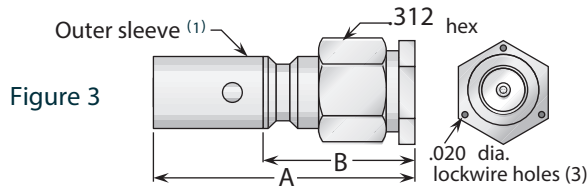
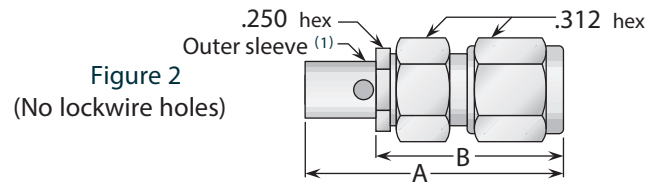
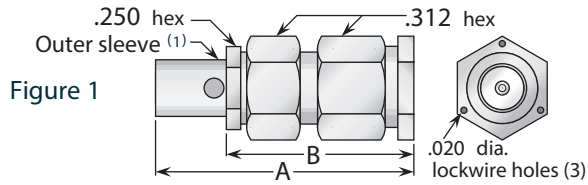

M39012 P/N	Category	Cable Group	Figure	Dimensions		Plating		Assembly Procedure/ Trim Code
				A	B	Body	Contact	
M39012/55-4006	A	I	1	1.25	.670	Gold ⁽³⁾	Gold (C)	M/01
M39012/55-4007	A	II	1	1.25	.670	Gold ⁽³⁾	Gold (C)	M/01
M39012/55-4008	A	IV	1	1.25	.670	Gold ⁽³⁾	Gold (C)	K/12
M39012/55-4009	A	VI	3	.940	.568	Gold ⁽³⁾	Gold (C)	K/12
M39012/55-4030	A	III	3	.940	.568	Gold ⁽³⁾	Gold (C)	M/01
M39012/55-4106	A	I	2	1.25	.670	Gold ⁽³⁾	Gold (C)	M/01
M39012/55-4107	A	II	2	1.25	.670	Gold ⁽³⁾	Gold (C)	M/01
M39012/55-4108	A	IV	4	.940	.568	Gold ⁽³⁾	Gold (C)	K/12
M39012/55-4109	A	VI	4	.940	.568	Gold ⁽³⁾	Gold (C)	K/12
M39012/55-4130	A	III	4	.940	.568	Gold ⁽³⁾	Gold (C)	M/01

(1) Category A: Solder sleeve with access hole as shown; Category C: Crimp sleeve without access hole.

(2) Coupling nut is passivated; body tail is gold plated for soldering of cable braid.

(3) All material is Beryllium Copper and Gold Plated.

•Assembly procedures start on page 205.

•See page 186 for cable groups and categories.

M39012/56- SMA Right Angle Plug

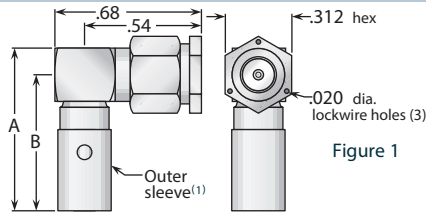

Figure 1

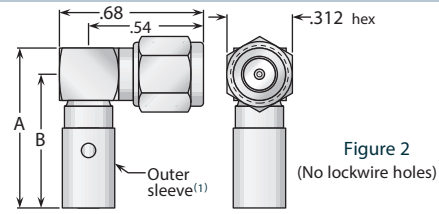

Figure 2
(No lockwire holes)

M39012 P/N	Category	Cable Group	Figure	Dimensions		Plating		Assembly Procedure/ Trim Code
				A	B	Body	Contact	
M39012/56-3006	A	I	1	.680	.550	Gold ⁽²⁾	Gold (C)	L / 06
M39012/56-3007	A	II	1	.680	.550	Gold ⁽²⁾	Gold (C)	L / 06
M39012/56-3008	A	IV	1	.760	.630	Gold ⁽²⁾	Gold (C)	L / 01
M39012/56-3009	A	VI	1	.760	.630	Gold ⁽²⁾	Gold (C)	L / 01
M39012/56-3025	C	I	1	.680	.550	Passivated	Gold (C)	L / 06
M39012/56-3026	C	IIA	1	.740	.610	Passivated	Gold (C)	L / 06
M39012/56-3027	C	IV	1	.680	.550	Passivated	Gold (C)	L / 06
M39012/56-3028	C	VIB	1	.690	.560	Passivated	Gold (C)	L / 06
M39012/56-3029	C	VIA	1	.710	.580	Passivated	Gold (C)	L / 06
M39012/56-3030	A	III	1	.680	.550	Gold ⁽²⁾	Gold (C)	L / 06
M39012/56-3106	A	I	2	.680	.550	Gold ⁽²⁾	Gold (C)	L / 06
M39012/56-3107	A	II	2	.680	.550	Gold ⁽²⁾	Gold (C)	L / 06
M39012/56-3108	A	IV	2	.760	.630	Gold ⁽²⁾	Gold (C)	L / 01
M39012/56-3109	A	VI	2	.760	.630	Gold ⁽²⁾	Gold (C)	L / 01
M39012/56-3125	C	I	2	.680	.550	Passivated	Gold (C)	L / 06
M39012/56-3126	C	IIA	2	.740	.610	Passivated	Gold (C)	L / 06
M39012/56-3127	C	IV	2	.680	.550	Passivated	Gold (C)	L / 06
M39012/56-3128	C	VIB	2	.690	.560	Passivated	Gold (C)	L / 06
M39012/56-3129	C	VIA	2	.710	.580	Passivated	Gold (C)	L / 06
M39012/56-3130	A	III	2	.680	.550	Gold ⁽²⁾	Gold (C)	L / 06
M39012/56-3502	D	XA	1	1.13	1.01	Passivated	Gold (C)	B / 40
M39012/56-3602	D	XA	2	1.13	1.01	Gold ⁽³⁾	Gold (C)	B / 40
M39012/56-4502	D	XA	1	1.13	1.01	Passivated	Gold (C)	B / 40
M39012/56-4602	D	XA	2	1.13	1.01	Gold ⁽³⁾	Gold (C)	B / 40

(1) (2) (3) See page 12 for notes.

M39012/57 - SMA Straight Jack

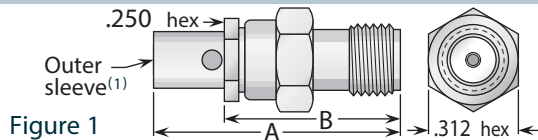

Figure 1

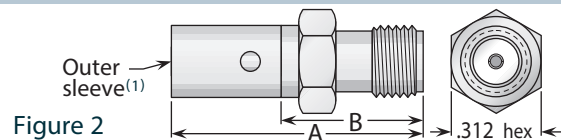
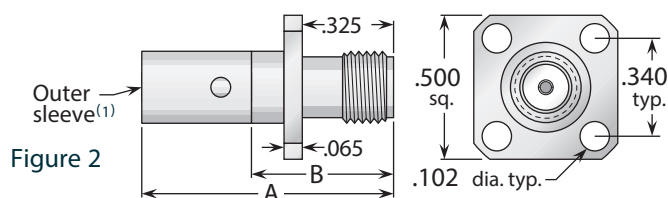
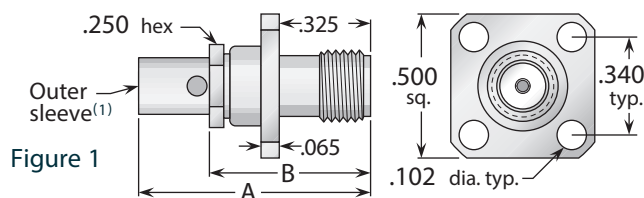

Figure 2

M39012 P/N	Category	Cable Group	Figure	Dimensions		Plating		Assembly Procedure/ Trim Code
				A	B	Body	Contact	
M39012/57-3006	A	I	1	.870	.630	Gold ⁽²⁾	Gold (C)	M / 01
M39012/57-3007	A	II	1	.870	.630	Gold ⁽²⁾	Gold (C)	M / 01
M39012/57-3008	A	IV	2	.900	.530	Gold	Gold (C)	K / 12
M39012/57-3009	A	VI	2	.900	.530	Gold	Gold (C)	K / 12
M39012/57-3025	C	I	1	.870	.630	Passivated	Gold (C)	M / 01
M39012/57-3026	C	IIA	1	.930	.630	Passivated	Gold (C)	M / 01
M39012/57-3027	C	IV	2	.910	.530	Passivated	Gold (C)	K / 12
M39012/57-3028	C	VIB	2	.910	.530	Passivated	Gold (C)	K / 12
M39012/57-3029	C	VIA	2	.930	.530	Passivated	Gold (C)	K / 12
M39012/57-3030	A	III	1	.870	.630	Gold ⁽²⁾	Gold (C)	M / 01
M39012/57-4007	A	II	1	.960	.630	Gold ⁽³⁾	Gold (C)	M / 01

(1) (2) (3) See page 196 for notes. •See page 186 for cable groups and category and definitions. •Assembly procedures start on page 205. •(C) indicates captive contact.

M39012/58 - SMA Panel Jack



M39012 P/N	Category	Cable Group	Figure	Dimensions		Plating		Assembly Procedure/ Trim Code
				A	B	Body	Contact	
M39012/58-3006	A	I	1	.870	.630	Gold ⁽²⁾	Gold (C)	M / 01
M39012/58-3007	A	II	1	.870	.630	Gold ⁽²⁾	Gold (C)	M / 01
M39012/58-3008	A	IV	2	.900	.530	Gold	Gold (C)	K / 12
M39012/58-3009	A	VI	2	.900	.530	Gold	Gold (C)	K / 12
M39012/58-3025	C	I	1	.870	.630	Passivated	Gold (C)	M / 01
M39012/58-3026	C	IIA	1	.930	.630	Passivated	Gold (C)	M / 01
M39012/58-3027	C	IV	2	.910	.530	Passivated	Gold (C)	K / 12
M39012/58-3028	C	VIB	2	.910	.530	Passivated	Gold (C)	K / 12
M39012/58-3029	C	VIA	2	.930	.530	Passivated	Gold (C)	K / 12
M39012/58-3030	A	III	1	.870	.630	Gold ⁽²⁾	Gold (C)	M / 01

M39012/59 - SMA Bulkhead Jack

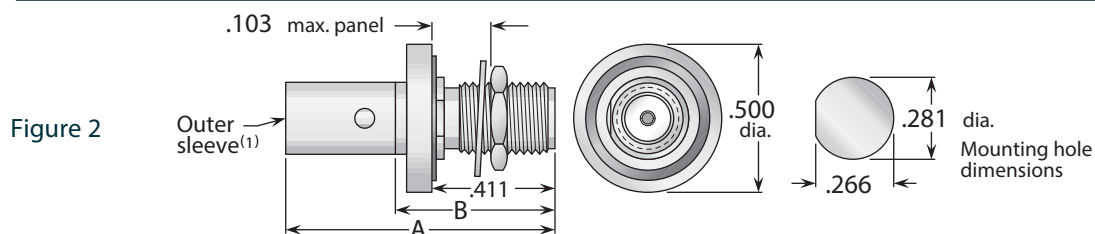
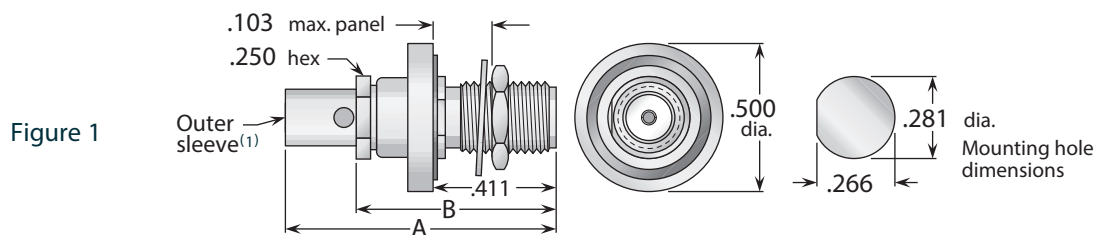

M39012 P/N	Category	Cable Group	Figure	Dimensions		Plating		Assembly Procedure/ Trim Code
				A	B	Body	Contact	
M39012/59-3006	A	I	1	.870	.630	Gold ⁽²⁾	Gold (C)	M / 01
M39012/59-3007	A	II	1	.870	.630	Gold ⁽²⁾	Gold (C)	M / 01
M39012/59-3008	A	IV	2	.900	.530	Gold	Gold (C)	K / 12
M39012/59-3009	A	VI	2	.900	.530	Gold	Gold (C)	K / 12
M39012/59-3025	C	I	1	.870	.630	Passivated	Gold (C)	M / 01
M39012/59-3026	C	IIA	1	.930	.630	Passivated	Gold (C)	M / 01
M39012/59-3027	C	IV	2	.910	.530	Passivated	Gold (C)	K / 12
M39012/59-3028	C	VIB	2	.910	.530	Passivated	Gold (C)	K / 12
M39012/59-3029	C	VIA	2	.930	.530	Passivated	Gold (C)	K / 12
M39012/59-3030	A	III	1	.870	.630	Gold ⁽²⁾	Gold (C)	M / 01
M39012/59-4009	A	IV	2	.960	.530	Gold ⁽³⁾	Gold (C)	K / 12

⁽¹⁾ Category A: Solder sleeve with access hole as shown; Category C: Crimp sleeve without access hole.

⁽²⁾ Mating thread area is passivated; body tail is gold plated for soldering of cable braid.

⁽³⁾ All Material is Beryllium Copper and Gold plated.

See page 186 for cable groups and category definitions. • Assembly procedures start on page 205. • (C) indicates captive contact.

M39012/60 - SMA Panel Jack Receptacle

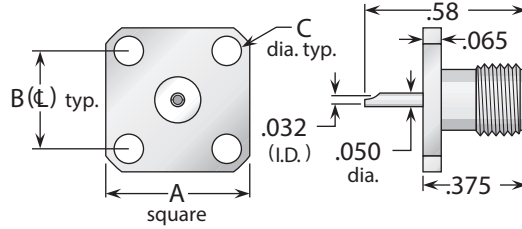

Figure 1

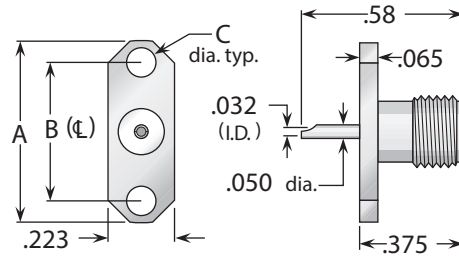

Figure 2

M39012 P/N	Figure	Dimensions			Plating	
		A	B	C	Body	Contact
M39012/60-3001	1	.500	.340	.102	Passivated	Gold (C)
M39012/60-3002	2	.625	.481	.102	Passivated	Gold (C)

M39012/61 - SMA Bulkhead Jack Receptacle

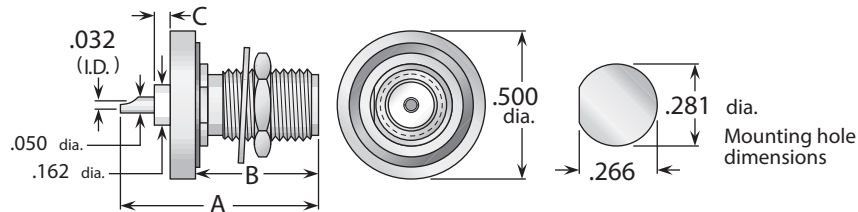

Figure 1 (Rear mount)

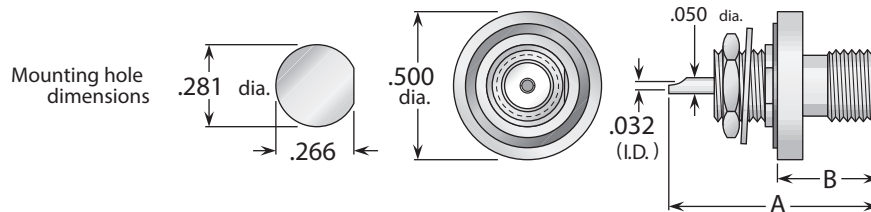

Figure 2 (Front mount)

M39012 P/N	Figure	Dimensions			Maximum Panel	Plating	
		A	B	C		Body	Contact
M39012/61-3001	1	.690	.415	.062	.103	Passivated	Gold (C)
M39012/61-3002	2	.690	.310	—	.103	Passivated	Gold (C)

(C) indicates captive contact.

M39012/25 - TNC Dust Caps

Figure 1 (Cap for TNC plug)

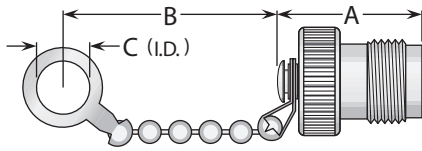

Figure 2 (Cap for TNC plug)

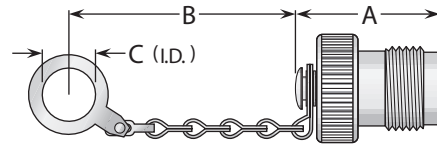

Figure 3 (Cap for TNC jack)

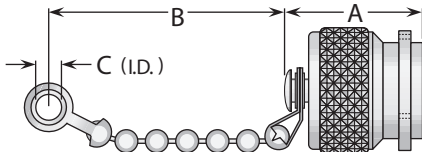
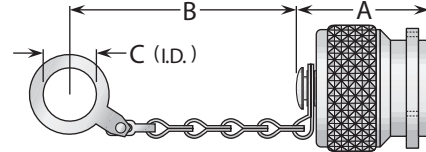

Figure 4 (Cap for TNC jack)



M39012 P/N	Figure	Dimensions			Chain Type	Plating	
		A	B	C		Body	Contact
M39012/25-0018	1	.680	3.25	.281	Bead	Silver	—
M39012/25-0019	2	.680	3.25	.281	Safety	Silver	—
M39012/25-0020	3	.700	2.25	.144	Bead	Silver	—
M39012/25-0021	4	.700	2.70	.515	Safety	Silver	—

M39012/26 - TNC Straight Plug

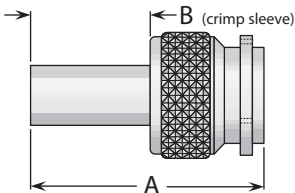

Figure 1

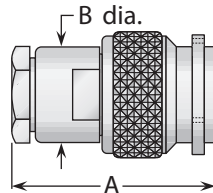

Figure 2



Coupling nut detail

M39012 P/N	Category	Cable Group	Figure	Dimensions		Plating		Assembly Procedure/ Trim Code
				A	B	Body	Contact	
M39012/26-0010	C	VIA	1	1.10	.500	Silver	Gold (C)	B / 19
M39012/26-0011	C	VIB	1	1.10	.500	Silver	Gold (C)	B / 19
M39012/26-0012	C	VIIA	1	1.10	.500	Silver	Gold (C)	B / 19
M39012/26-0013	C	IV	1	1.10	.500	Silver	Gold (C)	B / 19
M39012/26-0014	C	VIIB	1	1.10	.500	Silver	Gold (C)	B / 19
M39012/26-0018	A	II	2	1.06	.500	Silver	Gold (C)	A / 17
M39012/26-0022	C	IIA	1	1.04	.440	Silver	Gold (C)	Contact Factory
M39012/26-0023	C	V	1	1.10	.500	Silver	Gold (C)	B / 19
M39012/26-0101	A	VI	2	1.06	.500	Silver	Gold (C)	A / 17
M39012/26-0102	A	VII	2	1.06	.500	Silver	Gold (C)	A / 17
M39012/26-0103	A	IV	2	1.06	.500	Silver	Gold (C)	A / 17

See page 186 for cable groups and category definitions. • Assembly procedures start on page 205. • (C) indicates captive contact.

M39012/27 - TNC Straight Jack

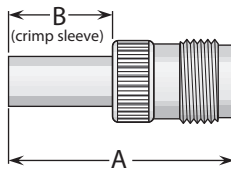

Figure 1

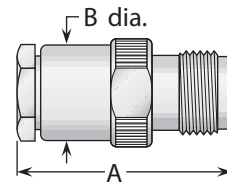

Figure 2

M39012 P/N	Category	Cable Group	Figure	Dimensions		Plating		Assembly Procedure/ Trim Code
				A	B	Body	Contact	
M39012/27-0010	C	VIA	1	1.19	.500	Silver	Gold (C)	B / 19
M39012/27-0011	C	VIB	1	1.19	.500	Silver	Gold (C)	B / 19
M39012/27-0012	C	VIIA	1	1.19	.500	Silver	Gold (C)	B / 19
M39012/27-0013	C	IV	1	1.19	.500	Silver	Gold (C)	B / 19
M39012/27-0014	C	VIIB	1	1.19	.500	Silver	Gold (C)	B / 19
M39012/27-0018	A	II	2	1.16	.500	Silver	Gold (C)	A / 17
M39012/27-0022	C	IIA	1	1.13	.440	Silver	Gold (C)	Contact Factory
M39012/27-0023	C	V	1	1.19	.500	Silver	Gold (C)	B / 19
M39012/27-0101	A	VI	2	1.16	.500	Silver	Gold (C)	A / 17
M39012/27-0102	A	VII	2	1.16	.500	Silver	Gold (C)	A / 17
M39012/27-0103	A	IV	2	1.16	.500	Silver	Gold (C)	A / 17

M39012/28 - TNC Bulkhead Jack

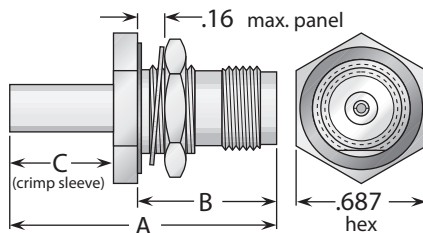

Figure 1

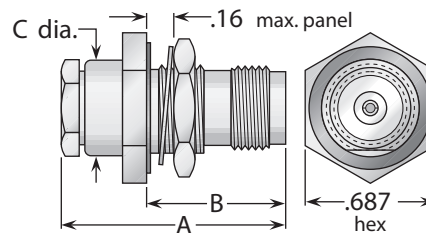
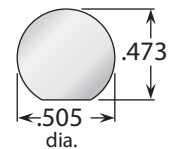

Figure 2



Mounting hole dimensions

M39012 P/N	Category	Cable Group	Figure	Dimensions			Plating		Assembly Procedure/ Trim Code
				A	B	C	Body	Contact	
M39012/28-0010	C	VIA	1	1.43	.810	.500	Silver	Gold (C)	B / 19
M39012/28-0011	C	VIB	1	1.43	.810	.500	Silver	Gold (C)	B / 19
M39012/28-0012	C	VIIA	1	1.43	.810	.500	Silver	Gold (C)	B / 19
M39012/28-0013	C	IV	1	1.43	.810	.500	Silver	Gold (C)	B / 19
M39012/28-0014	C	VIIB	1	1.43	.810	.500	Silver	Gold (C)	B / 19
M39012/28-0018	A	II	2	1.16	.810	.500	Silver	Gold (C)	A / 17
M39012/28-0022	C	IIA	1	1.37	.810	.440	Silver	Gold (C)	Contact Factory
M39012/28-0023	C	V	1	1.43	.810	.500	Silver	Gold (C)	B / 19
M39012/28-0101	A	VI	2	1.16	.810	.500	Silver	Gold (C)	A / 17
M39012/28-0102	A	VII	2	1.16	.810	.500	Silver	Gold (C)	A / 17
M39012/28-0103	A	IV	2	1.16	.810	.500	Silver	Gold (C)	A / 17

See page 186 for cable groups and category definitions. • Assembly procedures start on page 205. • (C) indicates captive contact.

M39012/29 - TNC Panel Jack

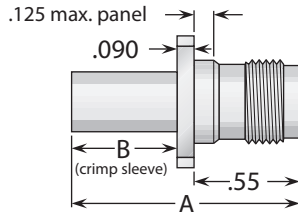

Figure 1

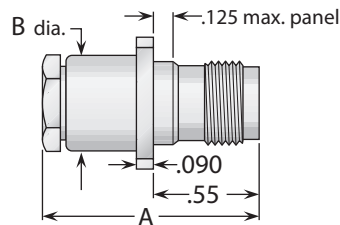
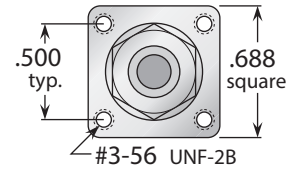

Figure 2



Flange dimensions

M39012 P/N	Category	Cable Group	Figure	Dimensions		Plating		Assembly Procedure/ Trim Code
				A	B	Body	Contact	
M39012/29-0010	C	VIA	1	1.17	.500	Silver	Gold (C)	B / 19
M39012/29-0011	C	VIB	1	1.17	.500	Silver	Gold (C)	B / 19
M39012/29-0012	C	VIIA	1	1.43	.500	Silver	Gold (C)	B / 19
M39012/29-0013	C	IV	1	1.17	.500	Silver	Gold (C)	B / 19
M39012/29-0014	C	VIIIB	1	1.17	.500	Silver	Gold (C)	B / 19
M39012/29-0018	A	II	2	1.16	.500	Silver	Gold (C)	A / 17
M39012/29-0022	C	IIA	1	1.13	.440	Silver	Gold (C)	Contact Factory
M39012/29-0023	C	V	1	1.17	.500	Silver	Gold (C)	B / 19
M39012/29-0101	A	VI	2	1.16	.500	Silver	Gold (C)	A / 17
M39012/29-0102	A	VII	2	1.16	.500	Silver	Gold (C)	A / 17
M39012/29-0103	A	IV	2	1.16	.500	Silver	Gold (C)	A / 17

M39012/31 - TNC Bulkhead Receptacle

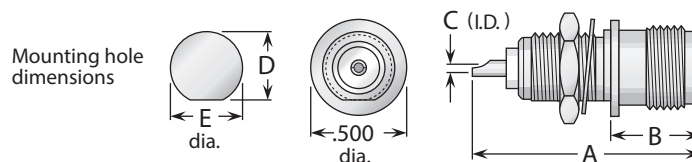

Figure 1

M39012 P/N	Figure	Dimensions					Maximum Panel	Plating	
		A	B	C	D	E		Body	Contact
M39012/31-0001	1	1.06	.470	.062	.410	.442	.130	Silver	Gold (C)
M39012/31-0002	1	1.19	.470	.062	.348	.380	.250	Silver	Gold (C)

(C) indicates captive contact.

M39012/32 - TNC Panel Receptacle

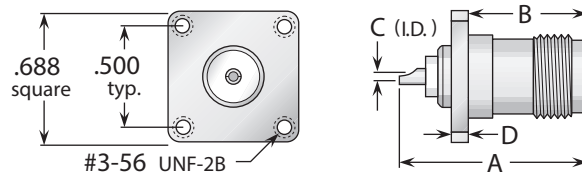

Figure 1

M39012 P/N	Figure	Dimensions				Maximum Panel	Plating	
		A	B	C	D		Body	Contact
M39012/32-0001	1	1.06	.630	.062	.090	.125	Silver	Gold (C)

M39012/34 - TNC Bulkhead Receptacle (Hermetically Sealed)

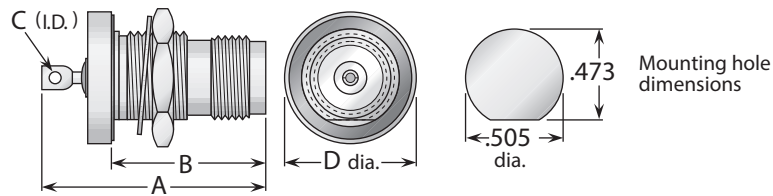

Figure 1
(Rear mount)

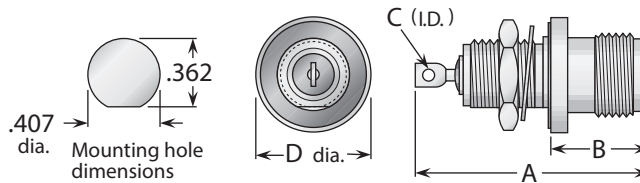

Figure 2
(Front Mount)

M39012 P/N	Figure	Dimensions				Maximum Panel	Plating	
		A	B	C	D		Body	Contact
M39012/34-0001	1	1.20	.830	.062	.687	.250	Silver	Gold (C)
M39012/34-0002	2	1.20	.520	.062	.594	.250	Silver	Gold (C)

(C) indicates captive contact.

M55339 - Adapters Between Series

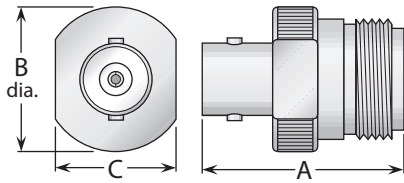

Figure 1 (BNC jack—N jack)

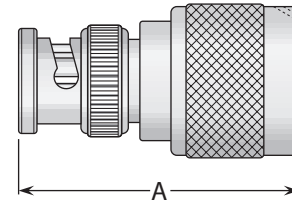

Figure 2 (BNC plug—N plug)

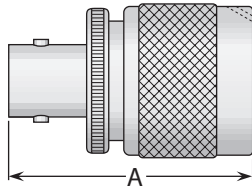

Figure 3 (BNC jack—N plug)

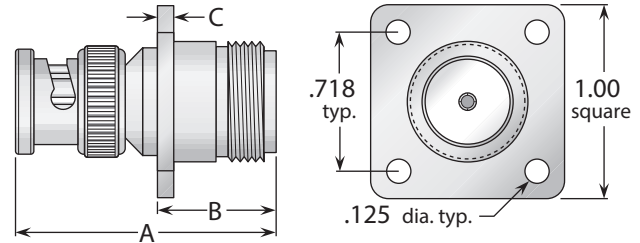

Figure 4
(BNC plug—N jack, panel mounted)

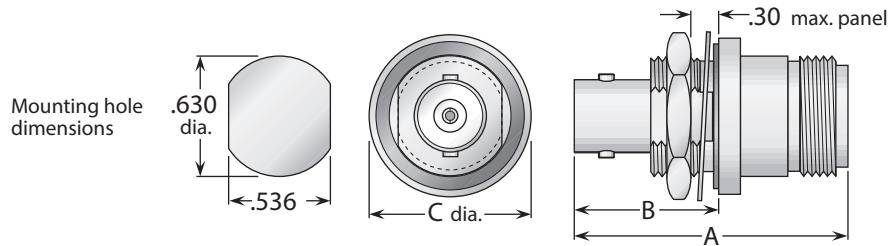

Figure 5
(BNC jack—N jack, bulkhead mounted, pressurized)

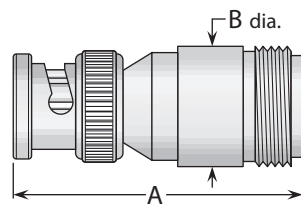

Figure 6 (BNC plug—N jack)

M55339 P/N	Figure	Dimensions			Plating	
		A	B	C	Body	Contact
M55339/01-00001	1	1.13	.75	.625	Silver	Gold (C)
M55339/18-01034	2	1.48	—	—	Silver	Gold (C)
M55339/20-00201	3	1.31	—	—	Silver	Gold (C)
M55339/24-00335	4	1.47	.736	.080	Silver	Gold (C)
M55339/25-00606	5	1.75	1.026	.812	Silver	Gold (C)
M55339/49-00349	6	1.47	.625	—	Silver	Gold (C)

(C) indicates captive contact.

Assembly Procedure A

Cable Trim Codes			
Code	A	B	C
A/01	.375	.047	.203
A/07	.375	.047	.125
A/17	.375	.109	.125
A/37	.281	.038	.188
A/38	.281	.069	.156

- 1) Trim cable jacket to dimension A. Slide backnut, washer, V-gasket, and braid clamp onto cable as shown. Cable jacket should bottom on step inside braid clamp.

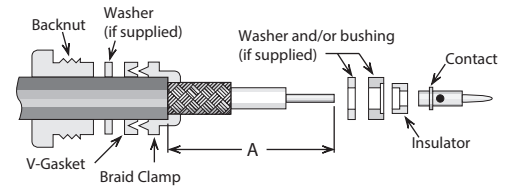

- 2) Comb braid wires out straight and fold back over front shoulder of braid clamp (braid wires should not overlap after folding). Trim braid wires flush with step of braid clamp. Trim cable dielectric and center conductor to dimensions B and C.

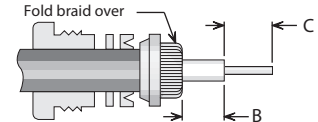

- 3) If support insulator is provided for RG-62 or 71 cable, insert into hollow in dielectric. Assemble rear bushing or washer (if supplied), rear insulator, and contact, and solder contact to center conductor. Rear of contact should be flush with cable dielectric end.

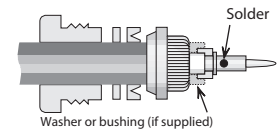

- 4) Insert prepared cable and hardware into body and tighten backnut.

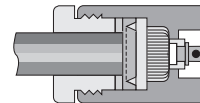

Assembly Procedure B

Cable Trim Codes			
Code	A	B	C
B/03	.406	.500	.187
B/10	.280	.436	.187
B/19	.343	.437	.156
B/40	.281	.390	.140

- 1) Trim cable per chart. Slide crimp sleeve back onto cable.

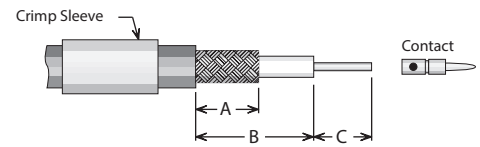

- 2) If support insulator is provided for RG-62 or 71 cable, insert into hollow in dielectric. Solder or crimp contact onto center conductor; back of contact flush with trimmed end of cable dielectric. Flare cut end of braid slightly by rotating dielectric.

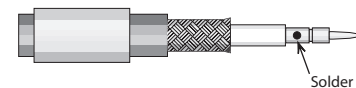

- 3) Insert cable/contact into rear of body, with all braid wires on outside of crimp tail. Push cable in until contact snaps into insulator. Slide crimp sleeve forward until flush with body and crimp (see page 20 for hex die sizes).

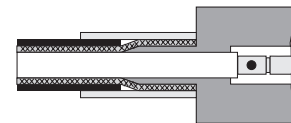

Assembly Procedure K

Cable Trim Codes			
Code	A	B	C
K/12	.281	.390	.140

- 1) Trim cable per chart. Slide crimp (or solder) sleeve onto cable.

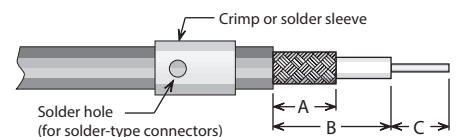

- 2) Solder contact onto center conductor, fixturing to maintain gap as shown. Flare cut end of braid slightly by rotating dielectric.

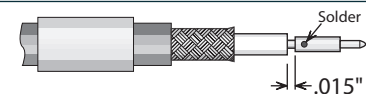

- 3) Insert cable/contact into rear of body, with all braid wires on outside of crimp tail. Push cable in until cable dielectric bottoms in connector. Slide crimp sleeve forward until flush with body and crimp (see page 20 for hex die sizes). (For solder-type connectors, solder braid to body and sleeve through hole in sleeve.)

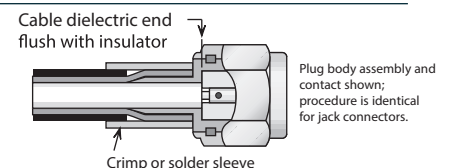

Assembly Procedure L

Cable Trim Codes

Code	A	B	C
L/01	.250	.438	.109
L/06	.281	.390	.070

- 1) Trim cable per chart. Slide crimp (or solder) sleeve onto cable.

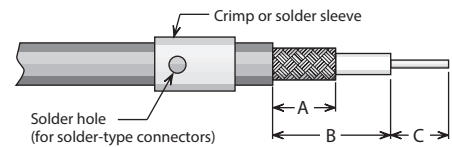

- 2) Insert cable into rear of body, with all braid wires on outside of crimp tail. Push cable in until end of braid touches connector body shoulder and center conductor rests in contact slot.

Slide crimp sleeve forward until flush with body and crimp (see page 20 for hex die sizes). (For solder-type connectors, solder braid to body and sleeve through hole in sleeve.)

Solder center conductor into contact slot, assemble insulator disc (if supplied), then press cap into body until seated or screw into place.

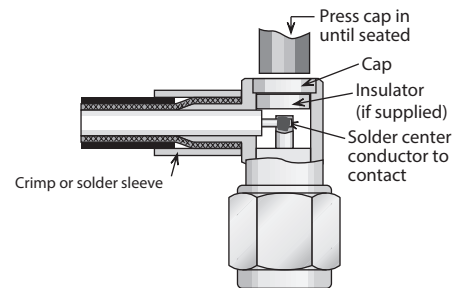

Assembly Procedure M

Cable Trim Codes

Code	A	B	C
M/01	.281	.390	.140

- 1) Trim cable per chart. Slide crimp (or solder) sleeve and backnut onto cable.

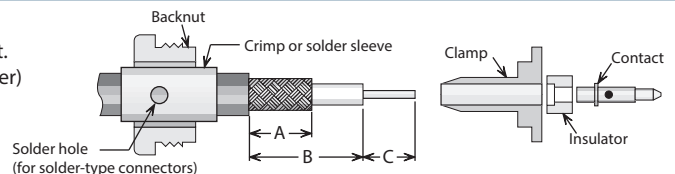

- 2) Flare cut end of braid slightly by rotating dielectric. Insert cable into rear of clamp, with all braid wires on outside of crimp tail. Slide insulator over cable dielectric until it is flush with front of clamp, and cable insulation bottoms inside insulator. Slide contact onto center conductor, with contact shoulder flush with front of insulator. Solder contact to center conductor.

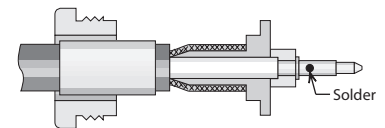

- 3) Slide crimp sleeve forward until flush with clamp shoulder; crimp as close to shoulder as possible. (see page 20 for hex die sizes). (For solder-type connectors, solder braid to body and sleeve through hole in sleeve.)

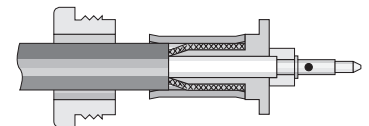

- 4) Insert prepared cable into back of body. Slide nut forward and tighten to 8-10 inch-pounds.

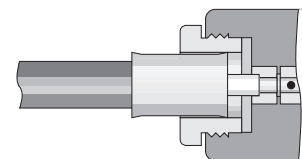

Crimp Tools for Flexible Cable



Frame only—P/N M22520/5-01 —Use with interchangeable dies listed below.

Hex Die Size	Die Set P/N	Closure
.429 hex, .400 wide	M22520/5-61	A
.213 hex, .400 wide	M22520/5-19	B
.255 hex, .400 wide	M22520/5-19	A
.128 hex, .400 wide	M22520/5-35	B
.151 hex, .400 wide	M22520/5-37	B
.105 hex, .400 wide	M22520/5-33	B

Part Number	Page	Part Number	Page	Part Number	Page	Part Number	Page	Part Number	Page
M39012/01-0005	191	M39012/17-0103	187	M39012/27-0010	201	M39012/55-3125	195	M39012/58-3006	198
M39012/01-0015	191	M39012/17-0111	187	M39012/27-0011	201	M39012/55-3126	195	M39012/58-3007	198
M39012/01-0016	191	M39012/17-0118	187	M39012/27-0012	201	M39012/55-3127	195	M39012/58-3008	198
M39012/01-0017	191	M39012/18-0101	187	M39012/27-0013	201	M39012/55-3128	195	M39012/58-3009	198
M39012/01-0018	191	M39012/18-0102	187	M39012/27-0014	201	M39012/55-3129	195	M39012/58-3025	198
M39012/01-0023	191	M39012/18-0103	187	M39012/27-0018	201	M39012/55-3130	195	M39012/58-3026	198
M39012/01-0024	191	M39012/18-0111	187	M39012/27-0022	201	M39012/55-4006	196	M39012/58-3027	198
M39012/01-0125	191	M39012/18-0118	187	M39012/27-0023	201	M39012/55-4007	196	M39012/58-3028	198
M39012/01-0501	191	M39012/18-0220	187	M39012/27-0101	201	M39012/55-4008	196	M39012/58-3029	198
M39012/01-0502	191	M39012/19-0101	188	M39012/27-0102	201	M39012/55-4009	196	M39012/58-3030	198
M39012/01-0503	191	M39012/19-0102	188	M39012/27-0103	201	M39012/55-4030	196	M39012/59-3006	198
M39012/01B0007	191	M39012/19-0110	188	M39012/28-0010	201	M39012/55-4106	196	M39012/59-3007	198
M39012/01B0008	191	M39012/19-0111	188	M39012/28-0011	201	M39012/55-4107	196	M39012/59-3008	198
M39012/02-0003	191	M39012/19-0118	188	M39012/28-0012	201	M39012/55-4108	196	M39012/59-3009	198
M39012/02-0006	192	M39012/19-0220	188	M39012/28-0013	201	M39012/55-4109	196	M39012/59-3025	198
M39012/02-0101	191	M39012/20-0006	188	M39012/28-0014	201	M39012/55-4130	196	M39012/59-3026	198
M39012/02-0104	192	M39012/20-0007	188	M39012/28-0018	201	M39012/56-3006	197	M39012/59-3027	198
M39012/02-0501	191	M39012/20-0101	188	M39012/28-0022	201	M39012/56-3007	197	M39012/59-3028	198
M39012/02-0502	191	M39012/20-0102	188	M39012/28-0023	201	M39012/56-3008	197	M39012/59-3029	198
M39012/02-0503	191	M39012/20-0108	188	M39012/28-0101	201	M39012/56-3009	197	M39012/59-3030	198
M39012/02-0511	192	M39012/21-0001	188	M39012/28-0102	201	M39012/56-3025	197	M39012/59-4009	198
M39012/02-0512	192	M39012/21-0002	188	M39012/28-0103	201	M39012/56-3026	197	M39012/60-3001	199
M39012/02-0513	192	M39012/21-0003	188	M39012/29-0010	202	M39012/56-3027	197	M39012/60-3002	199
M39012/02B0008	191	M39012/22-0001	189	M39012/29-0011	202	M39012/56-3028	197	M39012/61-3001	199
M39012/02B0009	191	M39012/24-0001	189	M39012/29-0012	202	M39012/56-3029	197	M39012/61-3002	199
M39012/03-0101	192	M39012/24-0002	189	M39012/29-0013	202	M39012/56-3030	197	M55339/01-00001	204
M39012/03-0102	192	M39012/25-0006	189	M39012/29-0014	202	M39012/56-3106	197	M39012/56-3106	197
M39012/03-0501	192	M39012/25-0007	189	M39012/29-0018	202	M39012/56-3107	197	M55339/04-00030	194
M39012/03-0502	192	M39012/25-0008	189	M39012/29-0022	202	M39012/56-3108	197	M55339/05-00057	194
M39012/03-0503	192	M39012/25-0009	189	M39012/29-0023	202	M39012/56-3109	197	M55339/06-00001	194
M39012/03B0004	192	M39012/25-0011	193	M39012/29-0101	202	M39012/56-3125	197	M55339/06-00028	194
M39012/03B0005	192	M39012/25-0012	193	M39012/29-0102	202	M39012/56-3126	197	M55339/07-00029	194
M39012/04-0001	193	M39012/25-0018	200	M39012/29-0103	202	M39012/56-3127	197	M55339/13-00492	190
M39012/04-0002	193	M39012/25-0019	200	M39012/31-0001	202	M39012/56-3128	197	M39012/56-3128	197
M39012/05-0101	193	M39012/25-0020	200	M39012/31-0002	202	M39012/56-3129	197	M39012/56-3129	197
M39012/16-0013	187	M39012/25-0021	200	M39012/32-0001	203	M39012/56-3130	197	M39012/56-3130	197
M39012/16-0014	187	M39012/25-3024	195	M39012/34-0001	203	M39012/56-3502	197	M39012/56-3502	197
M39012/16-0015	187	M39012/25-3025	195	M39012/34-0002	203	M39012/56-3602	197	M39012/56-3602	197
M39012/16-0016	187	M39012/25-3026	195	M39012/55-3006	195	M39012/56-4502	197	M39012/56-4502	197
M39012/16-0017	187	M39012/25-3027	195	M39012/55-3007	195	M39012/56-4602	197	M39012/56-4602	197
M39012/16-0101	187	M39012/26-0010	200	M39012/55-3008	195	M39012/57-3006	197	M39012/57-3006	197
M39012/16-0102	187	M39012/26-0011	200	M39012/55-3009	195	M39012/57-3007	197	M39012/57-3007	197
M39012/16-0103	187	M39012/26-0012	200	M39012/55-3025	195	M39012/57-3008	197	M39012/57-3008	197
M39012/16-0111	187	M39012/26-0013	200	M39012/55-3026	195	M39012/57-3009	197	M39012/57-3009	197
M39012/16-0118	187	M39012/26-0014	200	M39012/55-3027	195	M39012/57-3025	197	M39012/57-3025	197
M39012/16-0220	187	M39012/26-0018	200	M39012/55-3028	195	M39012/57-3026	197	M39012/57-3026	197
M39012/16-0222	187	M39012/26-0022	200	M39012/55-3029	195	M39012/57-3027	197	M39012/57-3027	197
M39012/16-0225	187	M39012/26-0023	200	M39012/55-3030	195	M39012/57-3028	197	M39012/57-3028	197
M39012/17-0101	187	M39012/26-0101	200	M39012/55-3106	195	M39012/57-3029	197	M39012/57-3029	197
M39012/17-0102	187	M39012/26-0102	200	M39012/55-3107	195	M39012/57-3030	197	M39012/57-3030	197
		M39012/26-0103	200	M39012/55-3108	195	M39012/57-4007	197		
				M39012/55-3109	195				

Other Military Part numbers: We still manufacture a broad line of older CW-, MX-, and UG- connectors, as listed below— for given UG numbers we can provide all letter variations (A/U, B/U, etc.).

CW-123/U	UG-83/U	UG-244/U	UG-423/U	UG-568/U	UG-633/U	UG-912/U	UG-997/U	UG-1148/U
CW-155/U	UG-88/U	UG-253/U	UG-427/U	UG-569/U	UG-634/U	UG-913/U	UG-1003/U	UG-1174/U
CW-159/U	UG-89/U	UG-255/U	UG-447/U	UG-570/U	UG-635/U	UG-914/U	UG-1016/U	UG-1185/U
CW-282/U	UG-94/U	UG-259/U	UG-464/U	UG-571/U	UG-636/U	UG-925/U	UG-1019/U	UG-1186/U
MX-554/U	UG-95/U	UG-260/U	UG-491/U	UG-572/U	UG-637/U	UG-926/U	UG-1033/U	UG-1187/U
MX-913/U	UG-105/U	UG-261/U	UG-492/U	UG-573/U	UG-642/U	UG-927/U	UG-1034/U	UG-1213/U
MX-1142/U	UG-107/U	UG-262/U	UG-493/U	UG-574/U	UG-643/U	UG-928/U	UG-1050/U	UG-1214/U
MX-1143/U	UG-108/U	UG-271/U	UG-494/U	UG-589/U	UG-657/U	UG-931/U	UG-1055/U	UG-1287/U
UG-18/U	UG-146/U	UG-273/U	UG-495/U	UG-593/U	UG-680/U	UG-932/U	UG-1056/U	UG-1320/U
UG-19/U	UG-154/U	UG-274/U	UG-496/U	UG-594/U	UG-690/U	UG-935/U	UG-1094/U	UG-1364/U
UG-20/U	UG-157/U	UG-290/U	UG-532/U	UG-602/U	UG-692/U	UG-937/U	UG-1095/U	UG-1365/U
UG-21/U	UG-159/U	UG-291/U	UG-533/U	UG-603/U	UG-701/U	UG-938/U	UG-1098/U	UG-1366/U
UG-22/U	UG-160/U	UG-306/U	UG-534/U	UG-604/U	UG-702/U	UG-940/U	UG-1098/U	UG-1412/U
UG-23/U	UG-167/U	UG-309/U	UG-535/U	UG-606/U	UG-703/U	UG-941/U	UG-1104/U	UG-1413/U
UG-27/U	UG-185/U	UG-333/U	UG-536/U	UG-624/U	UG-704/U	UG-943/U	UG-1107/U	UG-1424/U
UG-28/U	UG-201/U	UG-335/U	UG-556/U	UG-625/U	UG-705/U	UG-944/U	UG-1108/U	UG-1463/U
UF-29/U	UG-202/U	UG-349/U	UG-557/U	UG-626/U	UG-706/U	UG-945/U	UG-1109/U	UG-1464/U
UG-30/U	UG-203/U	UG-352/U	UG-559/U	UG-627/U	UG-707/U	UG-945/U	UG-1111/U	UG-1465/U
UG-57/U	UG-204/U	UG-394/U	UG-560/U	UG-628/U	UG-709/U	UG-961/U	UG-1132/U	UG-1487/U
UG-58/U	UG-212/U	UG-413/U	UG-564/U	UG-629/U	UG-710/U	UG-968/U	UG-1134/U	UG-1820/U
UG-59/U	UG-220/U	UG-414/U	UG-565/U	UG-630/U	UG-909/U	UG-972/U	UG-1138/U	UG-1841/U
UG-60/U	UG-225/U	UG-421/U	UG-566/U	UG-631/U	UG-910/U	UG-973/U	UG-1144/U	UG-1873/U
UG-61/U	UG-240/U	UG-422/U	UG-567/U	UG-632/U	UG-911/U	UG-981/U	UG-1146/U	UG-1915/U

Connector Flanges (Panel Mounted Connectors)

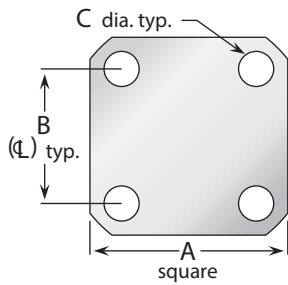

4-hole flanges			
Figure	A	B	C
04	1/2	.360	.089
05	1/2	.340	.102
07	11/16	.500	#3-56 tap
08	11/16	.500	.136
09	11/16	.500	.125
10	11/16	.500	.120
12	11/16	.500	.109
18	3/4	.531	.136
26	1	.718	#6-32 tap
27	1	.718	#4-40 tap
30	1	.718	.166
32	1	.718	.136
32A	1	.718	.136*
33	1	.718	.125
34	1 3/32	.812	.150
36	1 3/16	.906	#6-32 tap
39	1 3/16	.906	.152
40	1 3/16	.906	.125
45	2	1.437	.257
91	.375	.250	.067
91A	.375	.232	.093

* Countersunk to .245 dia.

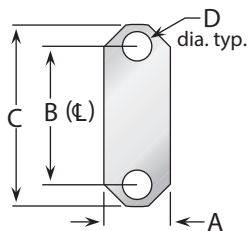

2-hole flanges				
Figure	A	B	C	D
92	.223	.481	.625	.102
92A	.260	.481	.625	.102
95	.640	1.015	1.30	.125

Panel Cutouts (Bulkhead Mounted Connectors)

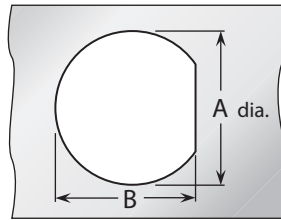

D-Hole		
Figure	A	B
51	.755	.723
54	.630	.598
55	.630	.583
57	.557	.531
59	.505	.473
62	.442	.410
63	.407	.362
65	.380	.348
66	.319	.292
67	.255	.236
68	.195	.176

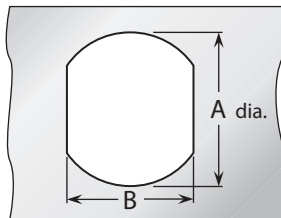

Double D-Hole		
Figure	A	B
69	.755	.692
72	.630	.536
75	.380	.341
84	.319	.278

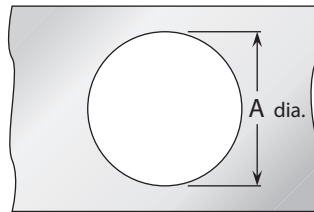

Round Hole	
Figure	A
82	.255
89	.380

P.C. Board Drilling

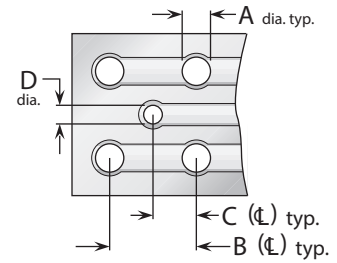

(PCB traces are shown for illustrative purpose only, and are not representative of actual circuitry.)

Coaxial connectors				
Figure	A	B	C	D
PCB01	.067	.400	.200	.045
PCB02	.045	.500	.250	.045
PCB03	.067	.300	.150	.035
PCB05	.067	.200	.100	.055
PCB06	.067	.200	.100	.045
PCB07	.045	.177	.088	.045
PCB08	.032	.100	.050	.032

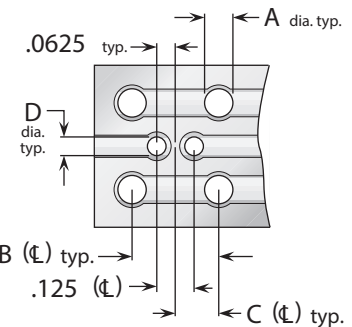

(PCB traces are shown for illustrative purpose only, and are not representative of actual circuitry.)

Twinax Connectors				
Figure	A	B	C	D
PCB04	.045	.500	.250	.045

Delta Cable Groups

Group	Cables
1	1A RG-5, 5A, 5B, 21, 21A; M17/73, /162
	1B RG-6, 6A; M17/2
	1C RG-143, 143A, 212, 222; M17/73, /112, /162
2	2A RG-8, 8A, 213; M17/74
	2B RG-11, 11A; M17/6
3	3A RG-9, 9A, 9B, 214; M17/75
	3B RG-13A, 216; M17/77
	3C RG-225; M17/127
4	RG-393; M17/127
5	RG-58, 58A, 58C, 141, 141A; M17/28, /111
6	6A RG-55A, 142, 142A, 223, 400; M17/60, /84, /128
	6B RG-55, 55B, 142B; M17/60, /84
7	7A RG-59, 59A, 59B, 62, 62A, 62B, 62C, 210; M17/29, /30, /97
	7B RG-71, 71A, 71B; M17/90
8	8A RG-122; M17/54
	8B RG-180, 180A, 180B, 195; M17/95, /137
9	9A RG-174, 188, 188A, 316; M17/152
	9B RG-179A, 179B, 187, 187A; M17/94, /136
10	Double-Shielded RG-174, 316; M17/152
11	RG-178, 178A, 178B, 196, 196A; M17/93
12	.250" semi-rigid; RG-401; M17/129
13	.141" semi-rigid; RG-402; M17/130
14	.085" semi-rigid; RG-405; M17/133
15	RG-10, 12, 215; M17/6, /74
16	RG-14A, 217; M17/78, /165
17	RG-17A, 218
18	RG-18A, 219
19	RG-115A
20	RG-118A, 228A
21	RG-126
22	RG-302
23	RG-303
24	RG-304
25	Special 8X cable; contact factory for details.
26	Belden 8281
27	RG-108, 108A; M17/45
28	RG-22, 22A, 22B; M17/15
29	Belden 9207; Dearborn 6207; IBM 7362211
30	M17/176
31	AT&T 735A

Cable Group Finder

Cable	Group	Cable	Group
RG-5, 5A, B	1A	RG-225	3C
RG-6, 6A	1B	RG-228A	20
RG-8, 8A	2A	RG-302	22
RG-9, 9A, B	3A	RG-303	23
RG-10	15	RG-304	24
RG-11, 11A	2B	RG-316	9A
RG-12	15	RG-316DS	10
RG-13A	3B	RG-393	4
RG-14A	16	RG-400	6A
RG-17A	17	RG-401	12
RG-18A	18	RG-402	13
RG-21, 21A	1A	RG-405	14
RG-22, 22A, B	28	M17/2	1B
RG-55, 55B	6B	M17/6	2B
RG-55A	6A	M17/15	28
RG-58, 58A, C	5	M17/28	5
RG-59, 59A, B	7A	M17/29	7A
RG-62, 62A, B, C	7A	M17/30	7A
RG-71, 71A, B	7B	M17/45	27
RG-108, 108A	27	M17/73	1A
RG-115A	19	M17/162	1A
RG-118A	20	M17/112	1C
RG-122	8A	M17/74	2A
RG-126	21	M17/75	3A
RG-141, 141A	5	M17/127	3C
RG-142, 142A	6A	M17/77	3B
RG-142B	6B	M17/60	6A
RG-143, 143A	1C	M18/84	6A
RG-174	9A	M17/128	6A
RG-174DS	10	M17/97	7A
RG-178, 178A, B	11	M17/54	8A
RG-179A, 179B	9B	M17/95	8B
RG-180, 180A, B	8B	M17/137	8B
RG-187, 187A	9B	M17/152	9A
RG-188, 188A	9A	M17/93	11
RG-195	8B	M17/129	12
RG-196, 196A	11	M17/130	13
RG-210	7A	M17/133	14
RG-212	1C	M17/78	16
RG-213	2A	M17/165	16
RG-214	3A	M17/176	30
RG-215	15	AT&T 735A	31
RG-217	16	Belden 8281	26
RG-218	17	Belden 9207	29
RG-219	18	Dearborn 6207	29
RG-222	1C	IBM 7362211	29
RG-223	6A		

Note: MIL-PRF-39012 QPL connectors have cable groups defined by the MIL specification, not the Delta cable groups shown here. See page 185 for M39012 cable groups.

Assembly Procedure A

- 1) Trim cable jacket to dimension A. Slide backnut, washer, V-gasket, and braid clamp onto cable as shown. Cable jacket should bottom on step in braid clamp.

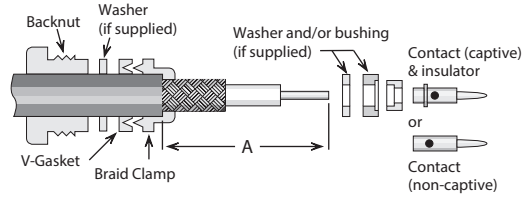

- 2) Comb braid wires out straight and fold back over front shoulder of braid clamp (braid wires should not overlap one another after folding). Trim braid wires flush with step of braid clamp. Trim cable dielectric and center conductor to dimensions B and C.

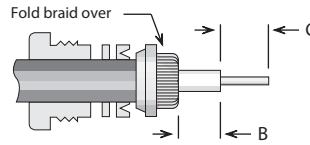

- 3) If support insulator is provided for RG-62 or 71 cable, insert into hollow in dielectric. Assemble rear bushing or washer (if supplied), rear insulator (if captive contact) and contact, and solder contact to center conductor. Rear of contact should be flush with cable dielectric end. For right angle connectors with access cap, omit this step entirely.

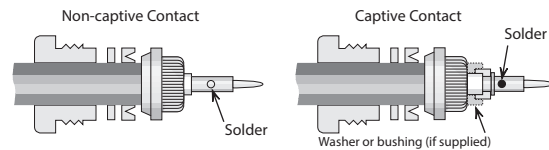

- 4) Insert prepared cable and hardware into body and tighten backnut. For right angle connectors with access cap, solder center conductor into slot in contact and tighten access cap.

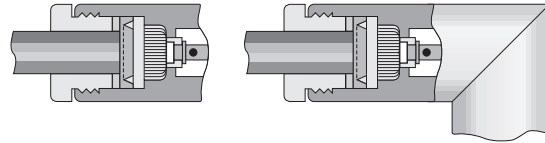

Trim Codes For Assembly Procedure A

Code	A	B	C	Code	A	B	C
A/01	.375 (3/8)	.047 (3/64)	.203 (13/64)	A/20	.375 (3/8)	.047 (3/64)	.172 (11/64)
A/02	.375 (3/8)	.109 (7/64)	.203 (13/64)	A/21	.500 (1/2)	.313 (5/16)	.172 (11/64)
A/03	.438 (7/16)	.250 (1/4)	.188 (3/16)	A/22	.375 (3/8)	.188 (3/16)	.141 (9/64)
A/04	.281 (9/32)	.047 (3/64)	.125 (1/8)	A/23	.438 (7/16)	.078 (5/64)	.172 (11/64)
A/05	.313 (5/16)	.125 (1/8)	.109 (7/64)	A/24	.500 (1/2)	.094 (3/32)	.141 (9/64)
A/06	.594 (19/32)	.391 (25/64)	.156 (5/32)	A/25	.438 (7/16)	.141 (9/64)	.172 (11/64)
A/07	.375 (3/8)	.047 (3/64)	.125 (1/8)	A/26	.625 (5/8)	.281 (9/32)	.250 (1/4)
A/08	.281 (9/32)	.109 (7/64)	.094 (3/32)	A/27	.688 (11/16)	.281 (9/32)	.125 (1/8)
A/09	.344 (11/32)	.109 (7/64)	.094 (3/32)	A/28	.656 (21/32)	.297 (19/64)	.250 (1/4)
A/10	.406 (13/32)	.109 (7/64)	.203 (13/64)	A/29	.688 (11/16)	.125 (1/8)	.313 (5/16)
A/11	.500 (1/2)	.281 (9/32)	.156 (5/32)	A/30	.688 (11/16)	.469 (15/32)	.156 (5/32)
A/12	.343	.040	.219	A/31	.700 (21/32)	.453 (29/64)	.250 (1/4)
A/13	.375 (3/8)	.125 (1/8)	.156 (5/32)	A/32	.313 (5/16)	.078 (5/64)	.188 (3/16)
A/14	.355	.090	.188 (3/16)	A/33	.250 (1/4)	.078 (5/64)	.094 (3/32)
A/15	.425	.094 (3/32)	.259	A/34	.250 (1/4)	.062 (1/16)	.109 (7/64)
A/16	.328 (21/64)	.094 (3/32)	.188 (3/16)	A/35	.837	.575	.150
A/17	.375 (3/8)	.109 (7/64)	.125 (1/8)	A/36	.450	.250	.150
A/18	.375 (3/8)	.062 (1/16)	.172 (11/64)	A/37	.281	.038	.188
A/19	.375 (3/8)	.188 (3/16)	.094 (3/32)	A/38	.281	.069	.156

Assembly Procedure B

- 1) Trim cable per chart. Slide crimp sleeve back onto cable.

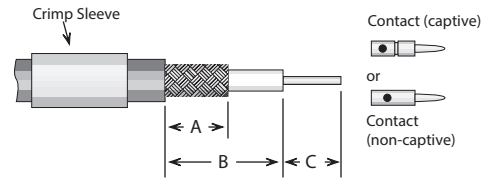

- 2) If support insulator is provided for RG-62 or 71 cable, insert into hollow in dielectric. Solder contact onto center conductor; back of contact flush with trimmed end of cable dielectric (omit this step for right angle connectors with access caps). Flare cut end of braid slightly by rotating dielectric.



- 3) Insert cable/contact into rear of body, with all braid wires on outside of crimp tail.
 - a) For captive contact connectors, push cable in until contact snaps into insulator.
 - b) For noncaptive contact connectors, push cable in until cable dielectric bottoms in connector.
 - c) For right angle or tee connectors with access caps, push cable in until end of braid touches connector body shoulder, and cable center conductor rests in contact slot.

Trim excess braid wires even with shoulder of body. Slide crimp sleeve forward until flush with body and crimp (see page 211 for hex die sizes).

For right angle or tee connectors with access caps: Solder center conductor into contact slot, assemble insulator disc (if supplied), then press cap into body until seated or screw into place.

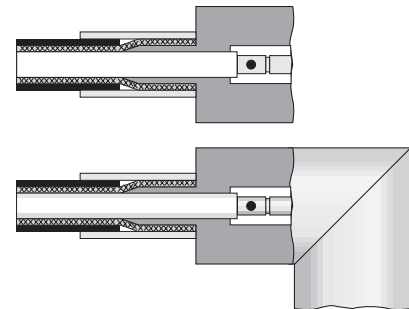

Trim Codes For Assembly Procedure B

Code	A	B	C	Code	A	B	C
B/01	.320	.470	.140	B/20	.250	.375	.156
B/02	.422	.578	.172	B/21	.425	.550	.156
B/03	.406	.500	.187	B/22	.375	.500	.156
B/04	.285	.505	.140	B/23	.281	.469	.125
B/05	.335	.460	.140	B/24	.250	.700	.109
B/06	.187	.437	.219	B/25	.343	.775	.125
B/07	.422	.610	.156	B/26	.343	.437	.109
B/08	.422	.562	.219	B/27	.313	.437	.187
B/09	.313	.610	.203	B/28	.219	.271	.078
B/10	.280	.436	.187	B/29	.200	.320	.060
B/11	.430	.542	.156	B/30	.500	.650	.219
B/12	.300	.434	.156	B/31	.350	.840	.150
B/13	.300	.447	.156	B/32	.175	.260	.095
B/14	.420	.645	.187	B/33	.195	.270	.045
B/15	.300	.420	.120	B/34	.150	.250	.105
B/16	.312	.609	.125	B/35	.195	.280	.170
B/17	.250	.500	.156	B/36	.150	.325	.090
B/18	.437	.562	.109	B/37	.195	.295	.075
B/19	.343	.437	.156	B/38	.150	.225	.095
				B/39	.250	.300	.135

Assembly Procedure C

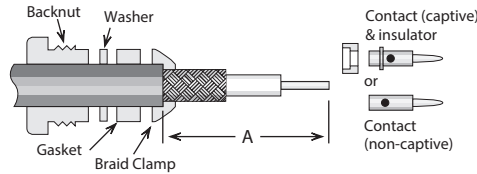

- 1) Trim cable jacket to dimension A. Slide backnut, washer, gasket, and braid clamp onto cable as shown. Cable jacket should bottom on step in braid clamp.

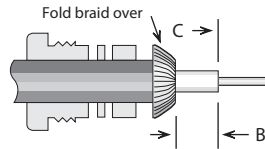

- 2) Comb braid wires out straight and fold back over front shoulder of braid clamp (braid wires should not overlap one another after folding). Trim braid wires flush with edge of braid clamp. Trim cable dielectric and center conductor to dimensions B and C.

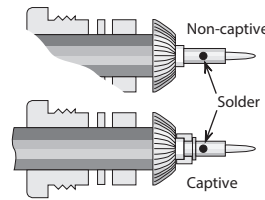

- 3) If support insulator is provided for RG-62 or 71 cable, insert into hollow in dielectric. Assemble rear insulator (if captive contact) and contact, and solder contact to center conductor. Rear of contact should be flush with cable dielectric end.

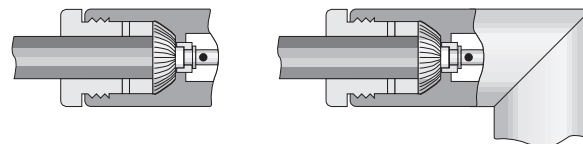

- 4) Insert prepared cable and hardware into body and tighten backnut. For right angle connectors with access cap, solder cable center conductor to slot in contact and tighten access cap.

Trim Codes			
Code	A	B	C
C/01	.656 (21/32)	.141 (9/64)	.250 (1/4)
C/02	.500 (1/2)	.125 (1/8)	.250 (1/4)
C/03	.450	.136	.187
C/04	.375 (3/8)	.109 (7/64)	.125 (1/8)
C/05	.375 (3/8)	.062 (1/16)	.250 (1/4)
C/06	.500 (1/2)	.188 (3/16)	.125 (1/8)
C/07	.575	.438	.094
C/08	.625 (5/8)	.141 (9/64)	.219 (7/32)

Assembly Procedure D

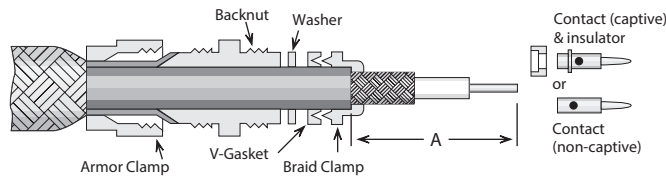

- 1) Slide armor clamp over cable. Push armor back to expose cable end. Slide backnut, washer (if supplied), gasket, and braid clamp onto cable as shown. Cable jacket should bottom on step in braid clamp. Trim cable jacket to dimension A.

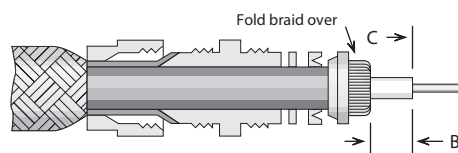

- 2) Comb braid wires out straight and fold back over front shoulder of braid clamp (braid wires should not overlap one another after folding). Trim braid wires flush with edge of braid clamp. Trim cable dielectric and center conductor to dimensions B and C.

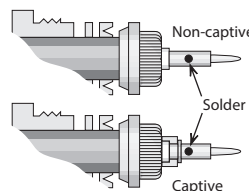

- 3) Assemble rear insulator (if captive contact) and contact, and solder contact to center conductor. Rear of contact should be flush with cable dielectric end.

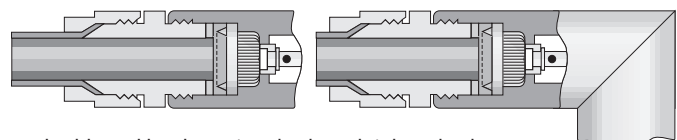

- 4) Insert prepared cable and hardware into body and tighten backnut. Trim armor to fit between armor clamp and braid clamp. Tighten armor clamp.

Trim Codes			
Code	A	B	C
D/01	.375 (3/8)	.047 (3/64)	.250 (1/4)
D/02	.500 (1/2)	.188 (3/16)	.219 (7/32)
D/03	.344 (11/32)	.047 (3/64)	.219 (7/32)
D/04	.313 (5/16)	.047 (3/64)	.172 (11/64)
D/05	.625 (5/8)	.281 (9/32)	.250 (1/4)
D/06	.313 (5/16)	.062 (1/16)	.109 (7/64)

Assembly Procedure E

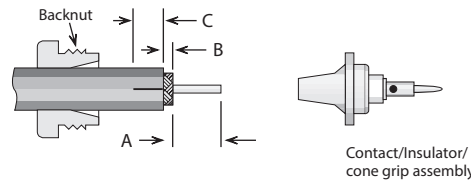

- 1) Slide backnut onto cable as shown. Trim cable to dimensions A and B as shown. Slit jacket to dimension C in two places, 180° apart.

Trim Codes			
Code	A	B	C
E/01	.250 (1/4)	.141 (9/64)	.313 (5/16)
E/02	.219 (7/32)	.063 (1/16)	.250 (1/4)
E/03	.250 (1/4)	.031 (1/32)	.250 (1/4)

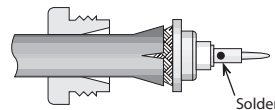

- 2) Slide cone/insulator/contact assembly under braid until braid is flush with shoulder. Solder contact to center conductor.

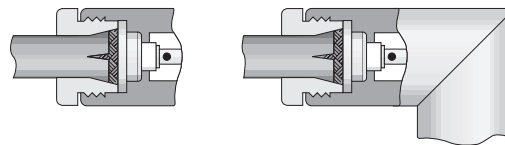

- 3) Insert prepared cable and hardware into body; tighten assembly by holding nut stationary and turning body.

Assembly Procedure F

Trim Codes		
Code	A	B
F/01	.250 (1/4)	.219 (7/32)
F/02	.250 (1/4)	.172 (11/64)
F/03	.188 (3/16)	.188 (3/16)
F/04	.109 (7/64)	.265 (17/64)
F/05	.156 (5/32)	.250 (1/4)
F/06	.219 (7/32)	.250 (1/4)
F/07	.156 (5/32)	.172 (11/64)
F/08	.109 (7/64)	.219 (7/32)

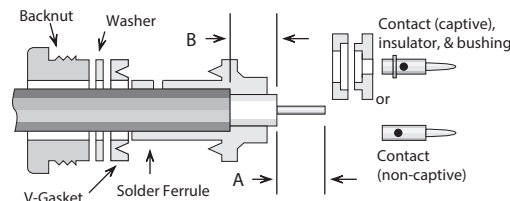

- 1) Trim cable per chart. Slide backnut, washer, v-gasket, and solder ferrule onto cable. Trimmed end of cable jacket should bottom on step in solder ferrule.

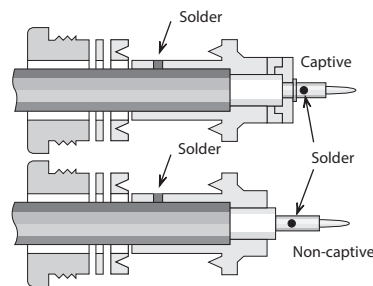

- 2) Solder ferrule to cable jacket as shown. Retrim cable dielectric to proper length if it has extruded from soldering heat. Slide bushing and rear insulator over cable dielectric if captive contact. Solder contact onto center conductor; back of contact flush with trimmed end of cable dielectric.

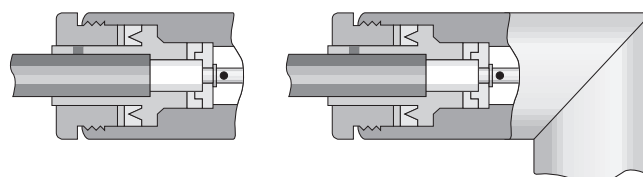

- 3) Insert prepared cable and hardware into body and tighten backnut.

Assembly Procedure G

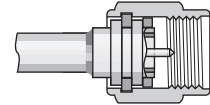
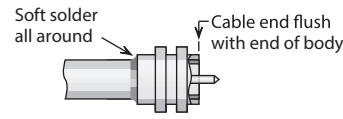
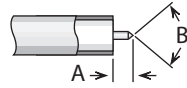
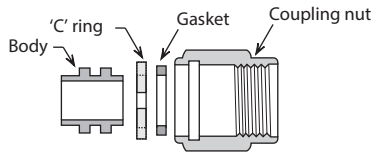

Trim Codes		
Code	A	B
G/01	.090	70-90°

1) Trim cable as shown. Remove any burrs from jacket and center conductor.

2) Soft solder cable jacket to body, making sure that end of cable is flush with end of body. After solder joint has cooled, retrim any protruding dielectric flush with end of body.

3) Assemble 'C' ring and gasket to body. Compress 'C' ring and slide body assembly into coupling nut until ring is seated in groove.

Assembly Procedure H

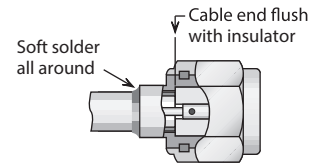
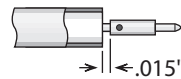
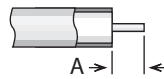
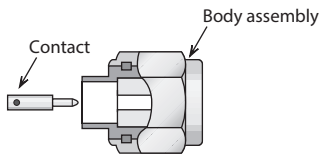

Trim Codes	
Code	A
H/01	.090
H/02	.060
H/03	.115
H/04	.150

1) Trim cable as shown. Remove any burrs from jacket and center conductor.

2) Solder contact to center conductor, fixturing to maintain gap as shown. Remove any excess solder from outside of contact.

3) Insert cable into body and solder cable jacket to body, keeping end of cable flush with insulator as shown.

Plug body assembly and contact shown; procedure is identical for jack connectors.

Assembly Procedure I

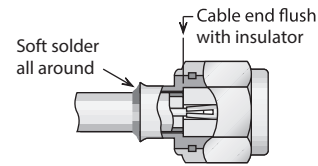
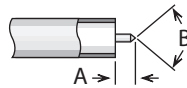
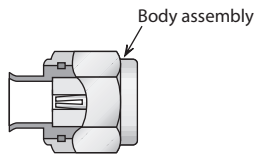

Trim Codes		
Code	A	B
I/01	.090	70-90°

1) Trim cable as shown. Remove any burrs from jacket and center conductor.

2) Insert cable into body and solder cable jacket to body, keeping end of cable flush with insulator as shown.

Plug body assembly and contact shown; procedure is identical for jack connectors.

Cable Positioner

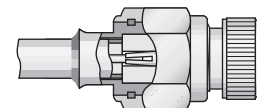
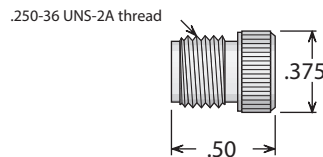

For .085" Cable:
P/N 63-10072-2

For .141" Cable:
P/N 63-10072-1

Using this positioner in the final step of assembly procedure H or I (for plugs only) will ensure that the contact and insulator are retained in the proper position to meet MIL-C-39012 requirements. The positioner should be screwed finger-tight into the mating end of the connector (as shown at right) before the cable jacket is soldered to the body assembly.

Assembly Procedure J

Trim Codes		
Code	A	B
J/01	.109	.047
J/02	.059	.039
J/03	.059	.079
J/04	.050	.059

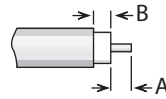

1) Trim cable as shown. Remove any burrs from jacket and center conductor.

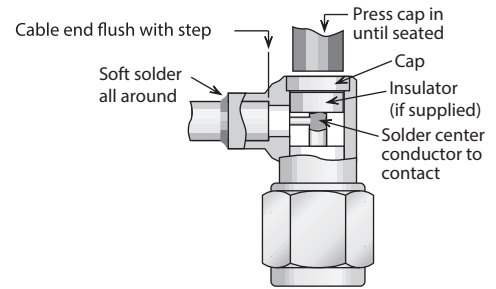

2) Soft solder cable jacket to body, making sure that end of cable is flush with step in body. Solder center conductor into contact slot, assemble insulator disc (if supplied), then press cap into body until seated or screw into place.

Assembly Procedure K

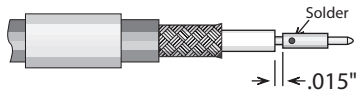
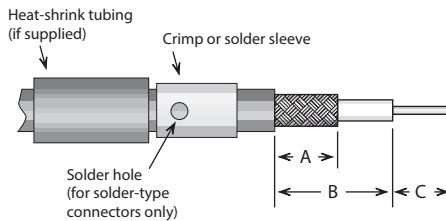

1) Trim cable per chart. Slide crimp (or solder) sleeve and heat-shrink tubing (if supplied) back onto cable.

2) Solder contact onto center conductor, fixturing to maintain gap as shown. Flare cut end of braid slightly by rotating dielectric.

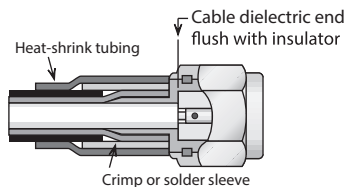

3) Insert cable/contact into rear of body, with all braid wires on outside of crimp tail. Push cable in until cable dielectric bottoms in connector. Trim excess braid wires even with shoulder of body. Slide crimp sleeve forward until flush with body and crimp (see page 211 for hex die sizes). (For solder-type connectors, solder braid to body and sleeve through hole in sleeve.) Slide heat-shrink tubing into place and shrink with hot-air gun.

Plug body assembly and contact shown; procedure is identical for jack connectors.

Trim Codes							
Code	A	B	C	Code	A	B	C
K/01	.250	.270	.110	K/07	.220	.290	.135
K/02	.200	.270	.140	K/08	.420	.620	.090
K/03	.225	.290	.110	K/09	.090	.135	.160
K/04	.225	.330	.110	K/10	.250	.415	.115
K/05	.250	.330	.110	K/11	.250	.400	.150
K/06	.250	.315	.095	K/12	.282	.390	.140

Assembly Procedure L

Trim Codes

Code	A	B	C
L/01	.250	.438	.109
L/02	.125	.219	.109
L/03	.234	.344	.109
L/04	.195	.270	.050
L/05	.095	.155	.050
L/06	.281	.390	.070

- 1) Trim cable per chart. Slide crimp (or solder) sleeve onto cable.

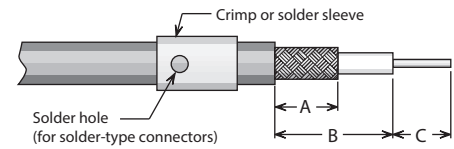

- 2) Insert cable into rear of body, with all braid wires on outside of crimp tail. Push cable in until end of braid touches connector body shoulder and center conductor rests in contact slot.

Slide crimp sleeve forward until flush with body and crimp (see page 211 for hex die sizes). (For solder-type connectors, solder braid to body and sleeve through hole in sleeve.)

Solder center conductor into contact slot, assemble insulator disc (if supplied), then press cap into body until seated or screw into place.

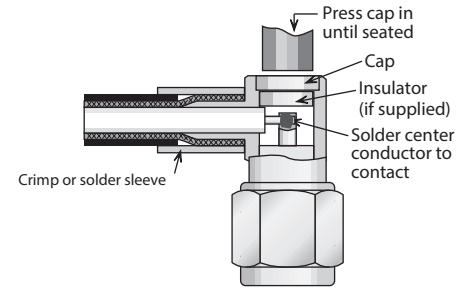

Assembly Procedure M

Cable Trim Codes

Code	A	B	C
M/01	.281	.390	.140

- 1) Trim cable per chart. Slide crimp (or solder) sleeve and backnut onto cable.

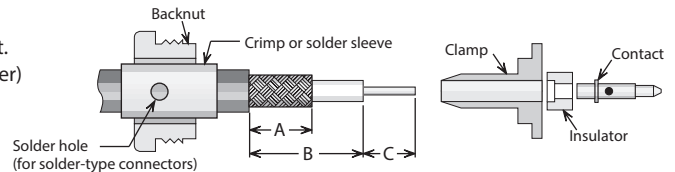

- 2) Flare cut end of braid slightly by rotating dielectric. Insert cable into rear of clamp, with all braid wires on outside of crimp tail. Slide insulator over cable dielectric until it is flush with front of clamp, and cable insulation bottoms inside insulator. Slide contact onto center conductor, with contact shoulder flush with front of insulator. Solder contact to center conductor.

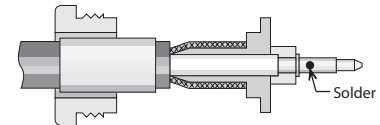

- 3) Slide crimp sleeve forward until flush with clamp shoulder; crimp as close to shoulder as possible. (see page 211 for hex die sizes). (For solder-type connectors, solder braid to body and sleeve through hole in sleeve.)

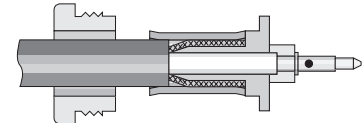

- 4) Insert prepared cable into back of body. Slide nut forward and tighten to 12–15 inch-pounds.

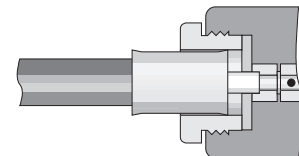

Crimp Tools For Flexible Cable



Frame only—P/N M22520/5-01 —Use with interchangeable dies listed below.

Cable Group*	Hex Die Size	Die Set P/N	Closure
2, 3, 4	.429 hex, .400 wide	M22520/5-61	A
5, 6	.213 hex, .400 wide	M22520/5-19	B
7	.255 hex, .400 wide	M22520/5-19	A
9	.128 hex, .400 wide	M22520/5-35	B
10	.151 hex, .400 wide	M22520/5-37	B
11	.105 hex, .400 wide	M22520/5-33	B

* For Delta cable groups. See MIL-PRF-39012 specifications for dies sizes used with M39012 cable groups.

Delta P/N	Page	Delta P/N	Page	Delta P/N	Page
10-10676-01-AG.....	170	1004019N005-000.....	16	1011036N070-000.....	20
10-10677-01-AG.....	170	1004021N000-000.....	15	1011036N071-000.....	20
10-10678-01-AG.....	170	1004021N001-000.....	15	1011037N075-000.....	21
10-10679-01-AG.....	170	1004025N003-000.....	15	1011038N070-000.....	20
10-10680-01-AG.....	170	1004029N005-000.....	16	1011038N071-000.....	20
10-10681-01-AG.....	170	1004031N003-000.....	15	1011038N075-000.....	21
10-10682-01-AG.....	170	1004036N000-000.....	15	1011043N075-000.....	21
10-10683-01-AG.....	170	1004037N005-000.....	16	1011100N075-000.....	21
10-10684-01-AG.....	170	1004038N005-000.....	16	1013000F181-000.....	22
10-10685-01-AG.....	170	1004043N000-000.....	15	1013000N090-000.....	22
10-10686-01-AG.....	170	1004043N005-000.....	16	1013000N100-000.....	22
10-10688-01-AG.....	170	1004100N005-000.....	16	1013000N180-000.....	22
1001001N000-001.....	13	1005014N000-000.....	15	1013000N330-000.....	22
1001015N001-000.....	13	1005021N000-001.....	15	1015000N070-000.....	23
1001015N005-003.....	14	1005029N000-000.....	15	1015000N090-000.....	23
1001018N005-000.....	14	1005036N000-000.....	15	1015000N330-000.....	23
1001019N005-000.....	14	1007015N000-000.....	16	1016004N511-000.....	18
1001021N001-000.....	13	1007017N000-003.....	16	1016015N591-000.....	18
1001025N003-000.....	13	1007019N000-001.....	16	1016015N595-000.....	19
1001029N001-000.....	13	1008004N000-000.....	17	1016018N595-000.....	19
1001029N005-001.....	14	1008015N001-000.....	17	1016019N595-000.....	19
1001031N003-000.....	13	1008015N005-000.....	17	1016021N591-000.....	18
1001036N000-000.....	13	1008018N005-001.....	17	1016025N593-000.....	19
1001036N001-000.....	13	1008019N005-000.....	17	1016029N595-000.....	19
1001037N005-000.....	14	1008021N001-000.....	17	1016031N593-000.....	19
1001038N000-000.....	13	1008025N003-000.....	17	1016036N590-000.....	18
1001038N005-000.....	14	1008029N005-000.....	17	1016036N591-000.....	18
1001043N000-000.....	13	1008031N003-000.....	17	1016037N595-000.....	19
1001043N001-000.....	13	1008036N000-000.....	17	1016038N590-000.....	18
1001043N005-000.....	14	1008036N001-000.....	17	1016038N591-000.....	18
1001100N005-000.....	14	1008037N005-000.....	17	1016038N595-002.....	19
1001132N000-000.....	13	1008038N000-000.....	17	1016043N595-000.....	19
1003005N000-000.....	14	1008038N005-002.....	17	1016100N595-002.....	19
1003013N000-000.....	14	1008043N005-000.....	17	1017014N570-000.....	18
1003013N00E-000.....	14	1008100N005-000.....	17	1019013N590-000.....	19
1003017N000-000.....	14	1010013N000-000.....	17	1019016N590-000.....	19
1003017N00E-002.....	14	1010017N000-001.....	17	1019020N590-000.....	19
1003019N00E-002.....	14	1010020N000-000.....	17	1020000F59G-000.....	25
1003020N000-002.....	14	1010020N001-001.....	17	1020000N911-001.....	27
1003020N000-005.....	14	1011001N330-000.....	20	1020000N911-002.....	27
1003020N000-006.....	14	1011004N330-000.....	20	1020000N911-013.....	27
1003020N001-005.....	14	1011015N071-000.....	20	1021000N591-000.....	25
1003020N001-009.....	14	1011015N075-000.....	21	1023000N330-000.....	23
1003037N000-000.....	14	1011018N075-000.....	21	1024000N651-000.....	25
1004001N000-000.....	15	1011019N075-000.....	21	1024000N911-004.....	27
1004004N000-000.....	15	1011021N071-000.....	20	1026000N591-000.....	29
1004015N001-000.....	15	1011025N073-000.....	20	1028000N001-003.....	29
1004015N005-000.....	16	1011029N075-000.....	21	1029000N000-003.....	30
1004018N005-000.....	16	1011031N073-000.....	20	1031000N000-004.....	28

Delta P/N	Page	Delta P/N	Page	Delta P/N	Page
1031000N00A-001.....	28	1103013N000-000.....	69	1111025N333-000.....	78
1031000N00A-003.....	28	1103017N000-000.....	69	1111027N331-000.....	77
1034000N000-000.....	30	1103017N001-000.....	69	1111031A091-001.....	78
1038000N000-002.....	30	1103018N001-000.....	69	1111031A333-004.....	78
1049000N000-000.....	30	1103020N000-000.....	69	1111031N333-001.....	78
1051000N000-000.....	28	1103020N001-000.....	69	1111036N330-000.....	77
1051000N00A-002.....	28	1103070N000-000.....	69	1111036N331-000.....	77
1051000N00A-005.....	28	1103079N000-000.....	69	1111037N335-001.....	77
1055015N091-000.....	21	1104027N001-000.....	71	1111100N335-001.....	77
1055017N091-000.....	21	1104032N001-000.....	71	1111123N300-000.....	77
1055019N091-000.....	21	1105004N000-000.....	71	1113000A331-001.....	79
1056000N000-000.....	26	1105015N000-000.....	71	1113000N091-002.....	79
1057000N000-000.....	26	1105015N001-000.....	71	1113000N181-000.....	79
1058000N04P-000.....	26	1105021N000-000.....	71	1113000N321-002.....	79
1058000N04P-001.....	26	1105036N001-000.....	71	1113000N321-003.....	79
1058000N051-000.....	22	1107002N000-000.....	71	1113000N331-011.....	79
1058000N091-000.....	22	1107002N000-001.....	71	1113000N331-028.....	81
1058000N13P-000.....	26	1107002N001-002.....	71	1113000N911-002.....	79
1058000N181-001.....	22	1107004N001-002.....	71	1113000N911-005.....	79
1063000N090-000.....	23	1107005N000-000.....	71	1113000N951-000.....	79
1067000N91P-001.....	26	1107034N001-001.....	71	1115000N330-005.....	82
1069000N03P-000.....	26	1108000N000-003.....	72	1115000N330-009.....	82
1069000N13P-000.....	26	1108004N005-002.....	73	1115000N330-011.....	82
1101001N001-000.....	68	1108015N000-000.....	72	1115000N330-012.....	82
1101004N005-000.....	69	1108015N001-000.....	72	1116003N721-001.....	74
1101015N001-000.....	68	1108015N005-000.....	73	1116004N720-001.....	74
1101015N005-000.....	69	1108018N005-002.....	73	1116004N725-000.....	75
1101015N005-000.....	69	1108019N005-002.....	73	1116015N721-000.....	74
1101021N001-000.....	68	1108021N001-000.....	72	1116015N725-000.....	75
1101021N005-000.....	69	1108027N001-000.....	72	1116015N725-001.....	75
1101025N003-000.....	70	1108029N005-001.....	73	1116021N720-000.....	74
1101031A003-008.....	70	1108031A003-000.....	73	1116021N721-000.....	74
1101031A003-012.....	70	1108037N005-002.....	73	1116021N725-000.....	75
1101031K00M-000.....	70	1108050A003-003.....	73	1116025A723-002.....	76
1101031N003-000.....	70	1108123N000-000.....	72	1116025N723-000.....	76
1101031N003-001.....	70	1110002N000-000.....	73	1116025N723-001.....	76
1101036N000-000.....	68	1110002N001-000.....	73	1116031A723-003.....	76
1101036N001-000.....	68	1110005N000-000.....	73	1116031N720-000.....	76
1101043N001-000.....	68	1110005N000-000.....	73	1116031N723-001.....	76
1101050A003-007.....	70	1110013N000-000.....	73	1116036N721-000.....	74
1101050N000-000.....	70	1111004N335-000.....	77	1116038N721-001.....	74
1101050N003-000.....	70	1111015N270-000.....	77	1116100N721-000.....	74
1101052N005-000.....	69	1111015N271-000.....	77	1116100N725-000.....	75
1101108N005-000.....	69	1111015N331-000.....	77	1116163N721-000.....	76
1101132N000-000.....	68	1111015N335-000.....	77	1119013N721-000.....	74
1103002N000-000.....	69	1111015N335-001.....	77	1119020N720-000.....	74
1103002N001-000.....	69	1111021N335-000.....	77	1119036N721-000.....	74
1103004N001-001.....	69	1111025A091-001.....	78	1119100N721-000.....	74
1103005N000-000.....	69	1111025A333-002.....	78	1120000N590-000.....	84

Delta P/N	Page	Delta P/N	Page	Delta P/N	Page
1120000N590-004.....	84	1156000N000-002.....	84	1201043N000-000.....	137
1120000N591-000.....	84	1156000N000-003.....	84	1201043N001-000.....	137
1120000N831-000.....	79	1157000N000-003.....	84	1201043N005-000.....	138
1120000N911-002.....	85	1158000A091-023.....	80	1201100N005-000.....	138
1120000N911-003.....	85	1158000A331-012.....	80	1203005N000-000.....	138
1120000N911-004.....	85	1158000N331-015.....	81	1203013N000-000.....	138
1121000N728-005.....	84	1159000N091-004.....	83	1203013N002-000.....	152
1123000N330-000.....	83	1159000N091-010.....	83	1203017N000-000.....	138
1123000N330-002.....	83	1159000N330-001.....	83	1203017N002-000.....	152
1123000N330-004.....	83	1159000N330-011.....	83	1203020N000-000.....	138
1124000N911-000.....	85	1159000N330-013.....	83	1203020N000-003.....	138
1124000N911-001.....	85	1159000N331-000.....	83	1203020N000-005.....	138
1124000N911-002.....	85	1159000N331-006.....	83	1203020N001-003.....	138
1125000N330-000.....	87	1159000N331-009.....	83	1204001N000-000.....	139
1126000N728-000.....	87	1159000N331-026.....	83	1204004N000-000.....	139
1131000N000-000.....	86	1163000N330-000.....	82	1204004N001-000.....	139
1131000N00A-000.....	86	1185002A000-000.....	72	1204015N000-000.....	139
1132000N00C-002.....	86	1185002A551-000.....	75	1204015N001-000.....	139
1133000N000-000.....	86	1185004A000-002.....	72	1204015N005-000.....	140
1133000N00C-000.....	86	1185004A551-000.....	75	1204018N005-000.....	140
1134000N000-000.....	87	1185013A001-000.....	72	1204019N005-000.....	140
1137000N000-000.....	88	1185013A551-000.....	75	1204021N000-000.....	139
1143000N051-002.....	81	1185019A000-000.....	72	1204021N001-000.....	139
1143000N091-002.....	80	1185019A551-000.....	75	1204025N003-000.....	140
1143000N091-003.....	80	1185031A000-000.....	72	1204029N005-000.....	140
1143000N091-004.....	80	1185031A551-000.....	75	1204031N003-000.....	140
1143000N091-009.....	80	1185036A000-000.....	72	1204036N000-000.....	139
1143000N091-018.....	81	1185036A551-000.....	75	1204037N005-000.....	140
1143000N091-030.....	81	1201001N000-000.....	137	1204038N005-000.....	140
1143000N091-059.....	81	1201004N000-000.....	137	1204043N005-000.....	140
1143000N091-069.....	81	1201004N001-004.....	137	1204100N005-000.....	140
1143000N091-073.....	81	1201015N000-000.....	137	1205018N000-000.....	139
1143000N091-075.....	81	1201015N001-000.....	137	1205021N000-000.....	139
1143000N330-010.....	80	1201015N005-000.....	138	1205029N000-000.....	139
1143000N330-012.....	80	1201018N005-000.....	138	1205036N000-001.....	139
1143000N330-018.....	81	1201019N005-000.....	138	1207015N000-000.....	140
1143000N331-017.....	80	1201021N000-000.....	137	1207017N000-000.....	140
1143000N331-023.....	80	1201021N001-000.....	137	1207020N000-000.....	140
1143000N331-054.....	80	1201025N003-000.....	139	1208001N000-000.....	141
1143000N331-055.....	80	1201029N000-000.....	137	1208004N000-000.....	141
1149000N001-001.....	88	1201029N001-000.....	137	1208015N000-000.....	141
1151000N000-000.....	86	1201029N005-000.....	138	1208015N001-000.....	141
1151000N000-003.....	86	1201031N003-000.....	139	1208015N005-000.....	141
1151000N000-010.....	86	1201036N000-000.....	137	1208018N005-001.....	141
1151000N000-011.....	86	1201036N001-002.....	137	1208019N005-000.....	141
1155013N331-000.....	78	1201037N005-000.....	138	1208021N000-000.....	141
1155017N331-000.....	78	1201038N000-000.....	137	1208021N001-000.....	141
1155037N331-000.....	78	1201038N001-000.....	137	1208025N003-000.....	141
1156000N000-000.....	84	1201038N005-000.....	138	1208029N005-000.....	141

Delta P/N	Page	Delta P/N	Page	Delta P/N	Page
1208031N003-000.....	141	1216018N595-000.....	142	1231000N000-000.....	148
1208036N000-000.....	141	1216019N595-000.....	142	1231000N00A-002.....	148
1208036N001-000.....	141	1216021N590-002.....	142	1232000N000-000.....	148
1208037N005-000.....	141	1216021N591-000.....	142	1232000N00A-000.....	148
1208038N000-000.....	141	1216021N59E-000.....	142	1232000N00C-000.....	148
1208038N005-000.....	141	1216025N593-000.....	142	1233000N000-002.....	148
1208043N005-000.....	141	1216029N595-000.....	142	1233000N00A-000.....	148
1208100N005-000.....	141	1216031N593-000.....	142	1233000N00C-000.....	148
1210013N000-000.....	141	1216036N590-000.....	142	1234000N000-000.....	150
1210013N002-000.....	152	1216036N591-005.....	142	1238000N000-000.....	151
1210017N000-000.....	141	1216037N595-000.....	142	1240004N000-000.....	137
1210017N002-000.....	152	1216038N590-002.....	142	1240004N001-000.....	137
1210020N000-000.....	141	1216038N591-001.....	142	1240015N000-000.....	137
1210020N001-000.....	141	1216038N595-000.....	142	1240015N001-000.....	137
1211001N330-000.....	143	1216043N595-000.....	142	1240021N000-000.....	137
1211004N330-000.....	143	1216100N595-002.....	142	1240021N001-000.....	137
1211015N070-000.....	143	1219013N590-002.....	142	1240025N003-000.....	139
1211015N071-000.....	143	1219013N592-000.....	152	1240031N003-000.....	139
1211015N075-000.....	143	1219017N590-000.....	142	1240036N000-000.....	137
1211018N075-001.....	143	1219017N592-000.....	152	1240036N001-000.....	137
1211019N075-000.....	143	1219020N590-000.....	142	1241000N000-000.....	151
1211021N070-000.....	143	1220000N620-000.....	146	1242000N000-000.....	151
1211021N071-000.....	143	1220000N622-000.....	152	1243000F09E-001.....	144
1211025N073-000.....	143	1220000N62E-001.....	146	1243000F09E-002.....	144
1211029N075-000.....	143	1220000N638-000.....	146	1249000N000-000.....	151
1211031N073-000.....	143	1220000N650-000.....	146	1256000N000-002.....	147
1211036N070-000.....	143	1220000N652-001.....	152	1256000N000-003.....	147
1211036N071-000.....	143	1220000N656-000.....	146	1258000N051-000.....	144
1211037N075-000.....	143	1220000N65E-000.....	146	1258000N091-009.....	144
1211038N070-000.....	143	1220000N65G-000.....	146	1258000N181-000.....	144
1211038N075-000.....	143	1220000N911-002.....	147	1258000N181-009.....	144
1211043N075-000.....	143	1220000N911-003.....	147	1259000N091-001.....	145
1211100N075-000.....	143	1220000N911-005.....	147	1259000N091-002.....	145
1212000N070-000.....	144	1221000N591-003.....	146	1259000N091-003.....	145
1213000N071-000.....	144	1221000N598-000.....	146	1261000A00M-001.....	149
1213000N072-005.....	152	1222000N630-001.....	146	1261000A00M-002.....	149
1213000N080-000.....	144	1222000N630-002.....	146	1261000A00M-003.....	149
1213000N090-000.....	144	1223000N180-000.....	145	1261000A00M-004.....	149
1213000N092-000.....	152	1223000N330-000.....	145	1261000A00M-005.....	149
1213000N180-000.....	144	1224000N911-002.....	147	1261000A00M-006.....	149
1213000N330-000.....	144	1225000N070-001.....	150	1263000N090-000.....	148
1215000N070-000.....	145	1226000N591-001.....	150	1301015G005-000.....	104
1215000N080-000.....	145	1226000N598-002.....	150	1301015K005-000.....	104
1215000N180-000.....	145	1227000N000-000.....	150	1301025G003-500.....	124
1215000N330-000.....	145	1228000N000-000.....	150	1301025G007-000.....	103
1216015N590-000.....	142	1229000N000-000.....	151	1301031G003-000.....	103
1216015N591-000.....	142	1230000N000-000.....	151	1301031G003-002.....	103
1216015N595-001.....	142	1231000N000-000.....	148	1301031G003-003.....	103
1216015N59E-000.....	142	1231000N000-005.....	148	1301031G003-500.....	124

Delta P/N	Page	Delta P/N	Page	Delta P/N	Page
1301031G003-501	124	1307100K001-000	104	1317025G673-001	105
1301031G003-502	124	1308013G000-000	106	1317025G673-500	124
1301031G007-000	103	1308013K000-000	106	1317025G677-000	105
1301031K003-000	103	1308017G000-000	106	1317031G673-000	105
1301031K003-002	103	1308017K000-000	106	1317031G673-003	105
1301031K003-008	103	1308025G003-500	124	1317031G673-500	124
1301031K003-012	103	1308025G007-000	105	1317031G677-000	105
1301037G005-000	104	1308031G003-002	105	1319013G670-000	106
1301037K005-000	104	1308031G003-004	105	1319013G670-500	125
1301094G003-000	103	1308031G003-500	124	1319013K670-000	106
1301094K003-000	103	1308031G007-000	105	1319017G670-000	106
1301094K003-001	103	1308037G000-000	106	1319017G670-500	125
1303013G000-000	104	1308037K000-000	106	1319017K670-000	106
1303013G000-500	125	1308094G003-000	105	1319037G670-000	106
1303013K000-002	104	1308094G003-001	105	1319037G670-500	125
1303017G000-000	104	1310013G000-500	125	1319037K670-000	106
1303017G000-500	125	1310017G000-500	125	1319038G670-500	125
1303017K000-000	104	1310037G000-500	125	1319100G670-000	106
1303036G000-000	104	1310038G000-500	125	1319100G670-500	125
1303036K000-000	104	1310100G000-500	125	1319100K670-000	106
1303037G000-500	125	1311025G053-000	105	1320000G671-000	113
1303038G000-500	125	1311025G053-001	105	1320000G671-005	113
1303100G000-002	104	1311025G053-500	124	1320000G821-000	113
1303100G000-500	125	1311025G923-500	124	1320000G821-002	113
1303100K000-002	104	1311031G053-000	105	1320000G911-076	115
1305025G003-000	103	1311031G053-003	105	1320000G911-078	115
1305025G003-500	124	1311031G053-500	124	1320000G911-084	115
1305025K003-000	103	1311031G923-500	124	1320000G911-085	115
1305031G003-000	103	1313000G051-000	107	1320000K671-000	113
1305031G003-002	103	1313000G051-500	126	1320000K671-005	113
1305031G003-500	124	1313000G091-000	107	1320000K821-000	113
1305031K003-000	103	1313000G331-000	107	1320000K821-011	113
1305031K003-004	103	1313000G911-000	107	1320000K911-002	115
1305094G003-003	103	1313000G921-000	107	1320000K911-003	115
1305094K003-005	103	1313000G921-002	107	1320000K911-004	115
1307013G001-000	104	1313000G921-500	126	1321000G671-500	127
1307013G001-500	125	1313000K051-002	107	1321000G820-003	113
1307013K001-000	104	1313000K091-000	107	1321000G821-000	113
1307017G001-000	104	1313000K331-000	107	1321000G821-500	127
1307017G001-500	125	1313000K911-000	107	1321000G821-501	127
1307017K001-000	104	1313000K921-000	107	1321000G821-065	113
1307036G001-000	104	1313000K921-002	107	1321000K820-003	113
1307036K001-000	104	1315000G050-000	112	1321000K821-014	113
1307037G001-500	125	1315000K050-000	112	1321000K821-065	113
1307038G001-000	104	1316015G675-000	106	1323000G051-500	128
1307038G001-500	125	1316015K675-000	106	1323000G920-000	119
1307038K001-000	104	1316037G675-000	106	1323000G921-001	119
1307100G001-000	104	1316037K675-000	106	1323000G921-500	128
1307100G001-500	125	1317025G673-000	105	1323000K920-000	119

Delta P/N	Page	Delta P/N	Page	Delta P/N	Page
1323000K921-001	119	1343000K911-006	109	1358000K051-019	111
1324000K911-002	115	1343000K920-004	109	1358000K051-034	111
1324000K911-003	115	1343000K921-006	109	1358000K051-035	111
1326000G678-000	121	1349000G000-000	122	1358000K051-128	111
1326000G821-000	121	1349000K000-000	122	1358000K090-000	110
1326000K821-001	121	1357000G000-002	112	1358000K090-001	108
1327000G000-000	121	1357000G000-006	112	1358000K091-008	108
1327000G001-500	129	1357000G000-012	112	1358000K091-014	110
1327000K000-002	121	1357000K000-002	112	1358000K091-015	111
1328000G000-000	121	1357000K000-006	112	1358000K091-016	111
1328000G001-500	129	1357000K000-012	112	1358000K330-000	110
1328000K000-001	121	1358000G050-000	110	1358000K330-001	108
1329000G000-000	122	1358000G050-005	108	1358000K331-002	108
1329000G001-500	129	1358000G051-000	110	1358000K331-003	110
1329000K000-000	122	1358000G051-019	111	1358000K331-004	111
1330000G000-000	122	1358000G051-003	108	1358000K331-005	111
1330000G001-500	129	1358000G051-034	111	1358000K910-002	108
1330000K000-000	122	1358000G051-035	111	1358000K910-003	110
1332000G000-000	120	1358000G051-128	111	1358000K911-014	111
1332000K000-000	120	1358000G051-500	126	1358000K911-059	108
1332000K00A-001	120	1358000G051-501	126	1358000K911-061	110
1332000K00B-000	120	1358000G090-000	110	1358000K911-085	111
1332000K00C-000	120	1358000G090-001	108	1358000K920-000	110
1333000G000-000	120	1358000G091-008	108	1358000K920-003	108
1333000K000-000	120	1358000G091-014	110	1358000K921-010	110
1333000K00A-000	120	1358000G091-015	111	1358000K921-063	108
1334000G000-000	121	1358000G091-016	111	1359000G050-000	119
1334000G001-500	129	1358000G330-000	110	1359000G050-005	117
1334000K000-000	121	1358000G330-001	108	1359000G050-007	118
1337000G000-001	122	1358000G331-002	108	1359000G051-010	116
1337000K000-001	122	1358000G331-003	110	1359000G051-038	118
1338000G001-500	129	1358000G331-004	111	1359000G051-004	119
1343000G050-006	109	1358000G331-005	111	1359000G051-045	117
1343000G051-021	109	1358000G910-002	108	1359000G051-500	128
1343000G090-001	109	1358000G910-003	110	1359000G051-501	128
1343000G091-006	109	1358000G911-014	111	1359000G910-002	117
1343000G330-006	109	1358000G911-059	108	1359000G910-003	119
1343000G331-011	109	1358000G911-061	110	1359000G910-004	118
1343000G910-003	109	1358000G911-085	111	1359000G911-013	116
1343000G911-006	109	1358000G920-000	110	1359000G911-014	117
1343000G920-004	109	1358000G920-003	108	1359000G911-015	119
1343000G921-006	109	1358000G921-010	110	1359000G911-023	118
1343000K050-006	109	1358000G921-063	108	1359000G920-001	117
1343000K051-021	109	1358000G921-500	126	1359000G920-002	118
1343000K090-001	109	1358000G921-501	126	1359000G921-017	116
1343000K091-006	109	1358000K050-004	110	1359000G921-018	116
1343000K330-006	109	1358000K050-005	108	1359000G921-019	117
1343000K331-011	109	1358000K051-000	110	1359000G921-020	118
1343000K910-003	109	1358000K051-003	108	1359000G921-500	128

Delta P/N	Page	Delta P/N	Page	Delta P/N	Page
1359000G921-501	128	1368000G91P-002	116	1701015N002-000	60
1359000K050-002	119	1368000G91P-003	116	1701029N000-000	60
1359000K050-005	117	1368000G91P-004	116	1701029N002-000	60
1359000K050-007	118	1368000G91P-005	116	1703017N000-000	60
1359000K051-004	119	1368000G91P-006	116	1703017N002-000	60
1359000K051-010	116	1369000G000-000	113	1703020N000-000	60
1359000K051-038	118	1369000G001-500	127	1703020N002-000	60
1359000K051-045	117	1369000G821-500	127	1705015N000-000	60
1359000K910-002	117	1370000G001-500	127	1705021N000-000	60
1359000K910-003	119	1395000G000-000	122	1708015N000-000	61
1359000K910-004	118	1395000K000-000	122	1711014N070-000	61
1359000K911-013	116	1401004N001-000	35	1711014N072-000	61
1359000K911-014	117	1401015N001-000	35	1713000N072-000	62
1359000K911-015	119	1404004N001-000	35	1719017N590-000	61
1359000K911-023	118	1404007N000-000	35	1719017N592-000	61
1359000K920-001	117	1408004N001-000	36	1719021N590-000	61
1359000K920-002	118	1411004N261-000	37	1719021N592-000	61
1359000K921-017	116	1411015N260-000	37	1720000N651-003	62
1359000K921-018	116	1413000N331-000	37	1720000N652-000	62
1359000K921-019	117	1413000N331-001	37	1720000N751-001	62
1359000K921-020	118	1416004N511-000	36	1801021N000-000	89
1363000G050-001	120	1423000N331-000	38	1808021N000-000	89
1363000G920-000	120	1426000N511-000	39	1813000N331-000	90
1363000K050-002	120	1463000N330-000	37	1815000N330-000	90
1363000K920-000	120	1502002A000-000	44	1816003N720-000	89
1364000G051-015	112	1502004A000-000	44	1816021N721-000	89
1364000G051-016	112	1502017A000-000	44	1819003N720-000	89
1364000K051-015	112	1513000A391-000	44	1819020N720-000	89
1364000K051-016	112	1516002A510-000	44	1820000N728-000	90
1366000G051-017	112	1516004A510-001	44	1823000N331-001	90
1366000G051-018	112	1601015N000-000	46	1827000N000-000	91
1366000G051-019	112	1601079N001-000	46	1828000N000-000	91
1366000K051-017	112	1604004N001-000	46	1829000N000-000	91
1366000K051-018	112	1604005N000-000	46	1830000N000-000	91
1366000K051-019	112	1604006N000-000	46	1838000N000-000	91
1367000G001-500	127	1604079N001-001	46	1901004N000-000	99
1367000G911-000	113	1605004N001-002	46	1901004N000-001	99
1367000G91P-000	114	1621000N691-000	48	1901004N001-000	99
1367000G91P-006	114	1623000N401-000	48	1901015N000-000	99
1367000G91P-020	114	1627000N000-000	49	1901015N001-000	99
1367000G91P-021	114	1628000N000-000	49	1904004N000-000	99
1367000G91P-022	114	1630000N000-000	50	1905015N001-002	99
1367000G91P-023	114	1632000N000-000	48	1913000N261-001	100
1367000G91P-024	114	1633000N000-000	48	1913000N261-002	100
1367000G91P-025	114	1634000N001-000	49	1913000N331-002	100
1367000G91P-026	114	1637000N000-000	50	1923000N331-000	100
1367000G91P-027	114	1638000N000-000	50	1926000N518-000	101
1368000G001-500	127	1663000N340-000	48	1927000N000-000	101
1368000G91P-001	116	1701015N000-000	60	1928000N000-000	101

Delta P/N	Page	Delta P/N	Page	Delta P/N	Page
1932000N000-000	100	2234000N000-035	43	2403037G000-002	131
1934000N000-001	101	2234000N000-036	42	2403037N000-002	131
1935000N000-001	101	2234000N000-037	42	2403038G000-001	131
1963000N330-000	100	2234000N000-038	43	2403038N000-001	131
2001070N000-000	157	2234000N000-039	43	2403100G000-000	131
2001099N000-000	157	2234000N000-040	43	2403100N000-000	131
2001235N000-000	157	2234000N000-041	42	2407037G001-000	131
2013000N091-002	157	2234000N000-042	42	2407037N001-000	131
2016099N591-000	157	2234000N000-043	43	2407038G001-001	131
2016235N591-001	157	2234000N000-044	43	2407038N001-001	131
2020000N621-003	157	2234000N000-045	42	2407100G001-000	131
2225000A911-009	175	2234000N000-046	43	2407100N001-000	131
2225000K071-002	183	2234000N000-047	43	2413000G051-000	132
2225000N331-005	181	2234000N000-048	42	2413000G911-000	132
2225000N331-006	177	2234000N000-049	43	2413000N051-000	132
2225000N331-008	181	2234000N000-050	43	2413000N911-000	132
2225000N401-000	180	2234000N000-051	42	2419037G681-000	131
2226000N721-001	181	2234000N000-052	42	2419037N681-000	131
2226000Q511-001	96	2234000N000-053	43	2419038G681-000	131
2227000N000-016	182	2234000N000-054	43	2419038N681-000	131
2227000N000-003	182	2234000N000-055	181	2419100G681-000	131
2227000N000-004	178	2234000N000-065	182	2419100N681-000	131
2228000A001-029	175	2234000N000-069	183	2420000G681-000	132
2228000N001-002	181	2234000N000-078	180	2420000K911-001	133
2228000N000-009	177	2234000N001-004	182	2420000N681-000	132
2228000N000-012	181	2234000N001-007	182	2421000G911-000	133
2228000N001-015	183	2234000N001-009	181	2422000G681-000	132
2228000N001-022	180	2234000N001-010	178	2422000N681-000	132
2228000N00M-010	181	2234000N001-051	179	2468000G001-000	133
2234000A001-122	175	2234000N001-070	180	2468000N001-000	133
2234000N000-006	177	2234000N001-077	183	2470000G00E-000	133
2234000N000-007	178	2234000N001-078	183	2470000N00E-000	133
2234000N000-008	177	2234000N001-081	183	2502038G001-001	134
2234000N000-009	178	2234000N001-082	183	2502038N001-001	134
2234000N000-010	179	2234000N001-100	177	2502045G001-001	134
2234000N000-011	179	2234000N001-120	183	2502045N001-001	134
2234000N000-012	182	2234000N001-121	183	2502100G000-001	134
2234000N000-014	42	2234000N004-010	178	2502100N000-001	134
2234000N000-015	43	2234000N004-011	180	2503037G000-000	134
2234000N000-017	42	2234000N00M-039	182	2503037N000-000	134
2234000N000-018	42	2234000N331-003	181	2503038G000-000	134
2234000N000-023	42	2234000Q001-131	96	2503038N000-000	134
2234000N000-024	43	2234000Q001-136	66	2503100G000-000	134
2234000N000-029	42	2402037G001-000	131	2503100N000-000	134
2234000N000-030	43	2402037N001-000	131	2507037G001-000	134
2234000N000-031	42	2402038G001-000	131	2507037N001-000	134
2234000N000-032	42	2402038N001-000	131	2507038G001-000	134
2234000N000-033	42	2402100G001-000	131	2507038N001-000	134
2234000N000-034	43	2402100N001-000	131	2507100G001-000	134

Delta P/N	Page	Delta P/N	Page	Delta P/N	Page
2507100N001-000.....	134	3527000N001-000.....	53	4422000G840-001.....	155
2513000G051-000.....	135	3801004Q000-001.....	93	4444000G628-000.....	155
2513000G911-000.....	135	3801015Q000-001.....	93	4463000A000-000.....	155
2513000N051-000.....	135	3805004Q000-000.....	93	5003005N001-000.....	163
2513000N911-000.....	135	3805006Q000-000.....	93	5003012N001-000.....	163
2519037G681-000.....	134	3805015Q000-000.....	93	5003013N001-000.....	163
2519037N681-000.....	134	3811004Q331-000.....	94	5013000N331-000.....	163
2519038G681-000.....	134	3811015Q331-000.....	94	5020000N651-000.....	163
2519038N681-000.....	134	3813000Q331-000.....	95	5023000N331-001.....	163
2519100G681-000.....	134	3816000Q511-002.....	95	6101099N001-000.....	161
2519100N681-000.....	134	3816004Q511-001.....	94	6102099N001-000.....	161
2520000G681-000.....	135	3816015Q511-001.....	94	6108099N001-000.....	161
2520000N681-000.....	135	3831000A00A-000.....	96	6116099N591-000.....	161
2522000G681-000.....	135	3851000A000-000.....	96	6120000N651-000.....	162
2522000N681-000.....	135	3858000Q331-001.....	95	6126000N591-000.....	162
2568000G001-000.....	135	3858000Q331-002.....	95	6128000N000-000.....	162
2568000N001-000.....	135	3858000Q331-003.....	95	6130000N000-000.....	162
2570000G00E-000.....	135	4203015Q000-000.....	66	6150000N000-000.....	162
2570000N00E-000.....	135	4213000Q071-001.....	66	6158000N13P-000.....	162
2601099N000-000.....	158	4217025G673-000.....	165	6169000N13P-000.....	162
2601201N000-000.....	158	4217031G673-000.....	165	63-10072-1.....	190
2604070N000-000.....	158	4220000G911-000.....	97	63-10072-2.....	190
2604201N000-000.....	158	4258000G051-000.....	165	7501019N005-000.....	31
2608070N000-000.....	159	4258000G051-009.....	97	7501037N005-000.....	31
2611201N331-000.....	159	4258000G051-010.....	165	7503020N000-002.....	31
2616070N511-000.....	159	4258000G921-002.....	165	7503020N001-000.....	31
2616201N511-000.....	159	4258000G921-003.....	165	7503037N001-000.....	31
2620000N511-000.....	159	4258000G921-006.....	97	7503108N001-000.....	31
2622000N511-000.....	159	4259000K051-000.....	11	7503279N001-000.....	31
2626000N000-000.....	160	4259000K911-005.....	11	7507019N000-000.....	31
2801000N000-000.....	40	4259000N911-002.....	11	7507037N000-000.....	31
2801000N000-001.....	40	4267000G91P-001.....	164	7513000N091-000.....	32
2802002F001-000.....	40	4401013G000-000.....	154	7513000N331-002.....	32
2802002F001-001.....	40	4401013G005-000.....	154	7516019N595-000.....	31
2802012N001-000.....	40	4401018G000-000.....	154	7516037N595-000.....	31
2802012N001-001.....	40	4401019G005-000.....	154	7520000N651-001.....	33
2802021N001-000.....	40	4401029G005-000.....	154	7521000N621-002.....	33
2802021N001-001.....	40	4401036G000-000.....	154	7523000N180-000.....	32
2802037N001-000.....	40	4401036G005-000.....	154	7523000N331-001.....	32
2802037N001-001.....	40	4401043G000-000.....	154	7526000N591-000.....	33
2811002N911-000.....	41	4404015G000-000.....	154	7526000N591-001.....	33
2811004N911-000.....	41	4404036G000-000.....	154	7527000N001-000.....	33
2811015N911-000.....	41	4408013G000-000.....	154	7528000N001-000.....	33
2811017N911-000.....	41	4408019G000-000.....	154	7529000N000-000.....	33
2811021N911-000.....	41	4408036G000-000.....	154	7567000N13P-001.....	32
2835000N000-000.....	41	4413000G041-000.....	155	7569000N13P-000.....	32
2835000N000-001.....	41	4416019G620-000.....	154	9201004A001-000.....	167
2838000N000-000.....	41	4416036G620-000.....	154	9201031A003-000.....	167
2838000N000-001.....	41	4416038G620-000.....	154	9201050A003-002.....	167

Delta P/N	Page	Delta P/N	Page	Delta P/N	Page
9201079A001-000.....	167	9503038G000-500.....	64	M22520/5-37.....	206
9203000A001-000.....	170	9505025G003-500.....	64	M22520/5-61.....	206
9203005A001-000.....	167	9507037G001-500.....	64	M39012/01-0005.....	191
9205005A001-002.....	167	9507038G001-500.....	64	M39012/01-0015.....	191
9205015A001-000.....	167	9510025G003-500.....	64	M39012/01-0125.....	191
9205031A003-000.....	167	9510037G000-500.....	64	M39012/01-0501.....	191
9205050A003-001.....	167	9510038G000-500.....	64	M39012/01-0502.....	191
9205079A001-001.....	167	9567000G001-500.....	65	M39012/01-0503.....	191
9207005A001-000.....	167	9567000G001-501.....	65	M39012/01B0007.....	191
9207015A001-000.....	167	9567000G001-502.....	65	M39012/01B0008.....	191
9207017A001-000.....	167	9567000G001-503.....	65	M39012/02-0003.....	191
9208000A001-000.....	170	9568000G001-500.....	65	M39012/02-0006.....	191
9211000A911-001.....	170	9568000G001-501.....	65	M39012/02-0101.....	191
9211031A331-000.....	168	9568000G001-502.....	65	M39012/02-0104.....	192
9211031A911-001.....	168	9569000G001-500.....	65	M39012/02-0501.....	191
9211050A331-000.....	168	9569000G001-501.....	65	M39012/02-0502.....	191
9211050A911-001.....	168	9801025G003-500.....	55	M39012/02-0503.....	191
9213000A911-003.....	171	9803037G000-500.....	55	M39012/02-0511.....	192
9213000A911-004.....	171	9803038G000-500.....	55	M39012/02-0512.....	192
9213000A911-010.....	171	9803100G000-500.....	55	M39012/02-0513.....	192
9216031A911-000.....	169	9805025G003-500.....	55	M39012/02B0008.....	191
9216050A911-000.....	169	9805031G003-500.....	55	M39012/02B0009.....	191
9219005A911-000.....	169	9807037G001-500.....	55	M39012/03-0101.....	192
9220000A911-000.....	171	9807038G001-500.....	55	M39012/03-0102.....	192
9223000A911-000.....	173	9807100G001-500.....	55	M39012/03-0501.....	192
9223000A911-001.....	173	9810037G001-500.....	56	M39012/03-0502.....	192
9223000A911-002.....	174	9810038G001-500.....	56	M39012/03-0503.....	192
9223000A911-003.....	173	9810100G001-500.....	56	M39012/03B0004.....	192
9224000A911-000.....	173	9819037G681-500.....	56	M39012/03B0005.....	192
9226000A911-001.....	175	9819038G681-500.....	56	M39012/04-0001.....	193
9255005A331-000.....	168	9819100G681-500.....	56	M39012/04-0002.....	193
9255005A911-000.....	168	9820000G911-001.....	58	M39012/05-0101.....	193
9255015A331-000.....	168	9820000G911-008.....	58	M39012/16-0101.....	187
9255015A911-000.....	168	9867000G001-500.....	57	M39012/16-0102.....	187
9258000A331-000.....	172	9867000G001-501.....	57	M39012/16-0103.....	187
9258000A331-002.....	172	9867000G001-503.....	57	M39012/16-0111.....	187
9258000A331-003.....	172	9867000G001-504.....	57	M39012/16-0118.....	187
9258000A331-005.....	172	9867000G91P-500.....	57	M39012/16-0220.....	187
9258000A331-010.....	172	9868000G001-500.....	58	M39012/16-0225.....	187
9258000A911-000.....	171	9869000G001-500.....	58	M39012/17-0101.....	187
9258000A911-006.....	172	9870000G001-500.....	58	M39012/17-0102.....	187
9258000A911-007.....	172	CW-123A/U.....	28	M39012/17-0103.....	187
9259000A331-000.....	174	CW-155A/U.....	28	M39012/17-0111.....	187
9259000A331-001.....	174	CW-159/U.....	28	M39012/17-0118.....	187
9259000A331-006.....	174	CW-282/U.....	28	M39012/18-0101.....	187
9259000A331-007.....	174	M22520/5-01.....	206	M39012/18-0102.....	187
9259000A911-004.....	174	M22520/5-19.....	206	M39012/18-0103.....	187
9501025G003-500.....	64	M22520/5-33.....	206	M39012/18-0111.....	187
9503037G000-500.....	64	M22520/5-35.....	206	M39012/18-0118.....	187

Delta P/N	Page	Delta P/N	Page	Delta P/N	Page
M39012/18-0220	187	M39012/27-0022	201	M39012/55-3128	195
M39012/19-0101	188	M39012/27-0023	201	M39012/55-3129	195
M39012/19-0102	188	M39012/27-0101	201	M39012/55-3130	195
M39012/19-0110	188	M39012/27-0102	201	M39012/56-3006	195
M39012/19-0111	188	M39012/27-0103	201	M39012/56-3007	197
M39012/19-0118	188	M39012/28-0010	201	M39012/56-3008	197
M39012/19-0220	188	M39012/28-0011	201	M39012/56-3009	197
M39012/20-0006	188	M39012/28-0012	201	M39012/56-3025	197
M39012/20-0007	188	M39012/28-0013	201	M39012/56-3026	197
M39012/20-0101	188	M39012/28-0014	201	M39012/56-3027	197
M39012/20-0102	188	M39012/28-0018	201	M39012/56-3028	197
M39012/20-0108	188	M39012/28-0022	201	M39012/56-3029	197
M39012/21-0001	188	M39012/28-0023	201	M39012/56-3030	197
M39012/21-0002	188	M39012/28-0101	201	M39012/56-3106	197
M39012/21-0003	188	M39012/28-0102	201	M39012/56-3107	197
M39012/22-0001	189	M39012/28-0103	201	M39012/56-3108	197
M39012/24-0001	189	M39012/29-0010	202	M39012/56-3109	197
M39012/24-0002	189	M39012/29-0011	202	M39012/56-3125	197
M39012/25-0006	189	M39012/29-0012	202	M39012/56-3126	197
M39012/25-0007	189	M39012/29-0013	202	M39012/56-3127	197
M39012/25-0008	189	M39012/29-0014	202	M39012/56-3128	197
M39012/25-0009	189	M39012/29-0018	202	M39012/56-3129	197
M39012/25-0011	193	M39012/29-0022	202	M39012/56-3130	197
M39012/25-0012	193	M39012/29-0023	202	M39012/57-3006	197
M39012/25-0018	200	M39012/29-0101	202	M39012/57-3007	197
M39012/25-0019	200	M39012/29-0102	202	M39012/57-3008	197
M39012/25-0020	200	M39012/29-0103	202	M39012/57-3009	197
M39012/25-0021	200	M39012/31-0001	202	M39012/57-3025	197
M39012/25-3024	195	M39012/31-0002	202	M39012/57-3026	197
M39012/25-3025	195	M39012/32-0001	203	M39012/57-3027	197
M39012/25-3026	195	M39012/34-0001	203	M39012/57-3028	197
M39012/25-3027	195	M39012/34-0002	203	M39012/57-3029	197
M39012/26-0010	200	M39012/55-3006	195	M39012/57-3030	197
M39012/26-0011	200	M39012/55-3007	195	M39012/58-3006	198
M39012/26-0012	200	M39012/55-3008	195	M39012/58-3007	198
M39012/26-0013	200	M39012/55-3009	195	M39012/58-3008	198
M39012/26-0014	200	M39012/55-3025	195	M39012/58-3009	198
M39012/26-0018	200	M39012/55-3026	195	M39012/58-3025	198
M39012/26-0022	200	M39012/55-3027	195	M39012/58-3026	198
M39012/26-0023	200	M39012/55-3028	195	M39012/58-3027	198
M39012/26-0101	200	M39012/55-3029	195	M39012/58-3028	198
M39012/26-0102	200	M39012/55-3030	195	M39012/58-3029	198
M39012/26-0103	200	M39012/55-3106	195	M39012/58-3030	198
M39012/27-0010	201	M39012/55-3107	195	M39012/59-3006	198
M39012/27-0011	201	M39012/55-3108	195	M39012/59-3007	198
M39012/27-0012	201	M39012/55-3109	195	M39012/59-3008	198
M39012/27-0013	201	M39012/55-3125	195	M39012/59-3009	198
M39012/27-0014	201	M39012/55-3126	195	M39012/59-3025	198
M39012/27-0018	201	M39012/55-3127	195	M39012/59-3026	198

Delta P/N	Page	Delta P/N	Page	Delta P/N	Page
M39012/59-3027	198	UG-29B/U	87	UG-422/U	160
M39012/59-3028	198	UG-306A/U	30	UG-423B/U	159
M39012/59-3029	198	UG-306B/U	30	UG-427C/U	47
M39012/59-3030	198	UG-309/U	177	UG-447/U	22
M39012/60-3001	199	UG-30D/U	87	UG-491B/U	30
M39012/60-3002	199	UG-30E/U	87	UG-492A/U	29
M39012/61-3001	199	UG-573B/U	35	UG-492C/U	29
M39012/61-3002	199	UG-57B/U	87	UG-492D/U	29
M55339/01-00001	204	UG-58A/U	79	UG-493A/U	160
M55339/03-00027	194	UG-59B/U	46	UG-494B/U	46
M55339/04-00030	194	UG-59E/U	46	UG-495D/U	46
M55339/05-00057	194	UG-60B/U	47	UG-496/U	48
M55339/06-00001	194	UG-60E/U	47	UG-532A/U	52
M55339/06-00028	194	UG-61B/U	47	UG-533B/U	53
M55339/07-00029	194	UG-61E/U	47	UG-534B/U	53
M55339/13-00492	190	UG-83B/U	181	UG-535/U	23
M55339/14-00306	190	UG-88/U	13	UG-536B/U	68
M55339/15-00491	190	UG-88C/U	13	UG-536C/U	68
M55339/16-00914	190	UG-88E/U	13	UG-556B/U	74
M55339/17-00001	190	UG-89C/U	17	UG-557A/U	68
M55339/17-00002	190	UG-107B/U	88	UG-564/U	179
M55339/17-00274	190	UG-146A/U	182	UG-565A/U	179
M55339/18-01034	204	UG-154B/U	52	UG-566A/U	39
M55339/20-00201	204	UG-157B/U	53	UG-567A/U	39
M55339/24-00335	204	UG-160D/U	74	UG-568/U	37
M55339/25-00606	204	UG-185/U	22	UG-569A/U	38
M55339/49-00349	204	UG-201A/U	177	UG-570A/U	36
MX-554/U	28	UG-202A/U	88	UG-571A/U	37
MX-554A/U	28	UG-203/U	163	UG-572A/U	36
MX-913/U	86	UG-204A/U	68	UG-593A/U	77
MX-1142A/U	39	UG-255A/U	178	UG-594B/U	71
MX-1143A/U	39	UG-260/U	13	UG-602A/U	72
PL-259A	163	UG-260B/U	13	UG-603A/U	68
UG-18E/U	68	UG-260D/U	13	UG-606/U	177
UG-20E/U	72	UG-261C/U	17	UG-624/U	18
UG-212C/U	50	UG-262C/U	20	UG-625B/U	24
UG-216B/U	53	UG-273/U	177	UG-626B/U	35
UG-21B/U	68	UG-274A/U	30	UG-627B/U	35
UG-21D/U	68	UG-274B/U	30	UG-628A/U	35
UG-21E/U	68	UG-274C/U	30	UG-629A/U	37
UG-21G/U	68	UG-290A/U	22	UG-630A/U	36
UG-220B/U	53	UG-291C/U	20	UG-631A/U	36
UG-22D/U	77	UG-333C/U	47	UG-632A/U	36
UG-22F/U	77	UG-335A/U	178	UG-633A/U	36
UG-23D/U	72	UG-349B/U	178	UG-634/U	38
UG-23F/U	72	UG-352/U	52	UG-635/U	178
UG-27C/U	88	UG-352B/U	52	UG-636A/U	177
UG-27D/U	88	UG-414A/U	29	UG-637/U	179
UG-28A/U	88	UG-421B/U	158	UG-642A/U	39

Delta P/N	Page	Delta P/N	Page	Delta P/N	Page
UG-643/U	39	UG-927B/U	47	UG-1095C/U	77
UG-657/U	24	UG-931/U	62	UG-1098/U	24
UG-657A/U	24	UG-932A/U	60	UG-1098A/U	24
UG-680/U	84	UG-937A/U	36	UG-1104A/U	23
UG-680A/U	84	UG-938A/U	37	UG-1107/U	180
UG-703A/U	179	UG-940B/U	72	UG-1108/U	180
UG-704B/U	36	UG-941B/U	68	UG-1109/U	50
UG-706A/U	38	UG-943B/U	35	UG-1111/U	95
UG-707A/U	35	UG-944A/U	36	UG-1132A/U	94
UG-709B/U	35	UG-945B/U	35	UG-1138A/U	39
UG-710B/U	35	UG-94A/U	89	UG-1144/U	96
UG-909/U	18	UG-959A/U	13	UG-1148/U	46
UG-909A/U	18	UG-95A/U	89	UG-1174/U	24
UG-909B/U	18	UG-961A/U	61	UG-1185/U	68
UG-910/U	18	UG-968B/U	93	UG-1185A/U	68
UG-910A/U	18	UG-972B/U	94	UG-1186/U	72
UG-910B/U	18	UG-981/U	160	UG-1186A/U	72
UG-911A/U	24	UG-997A/U	82	UG-1187/U	77
UG-912/U	24	UG-1016A/U	61	UG-1187A/U	77
UG-912A/U	24	UG-1019A/U	49	UG-1213/U	46
UG-913/U	15	UG-1033C/U	13	UG-1214/U	47
UG-913A/U	15	UG-1034/U	178	UG-1365/U	155
UG-914/U	29	UG-1094/U	24	UG-1366/U	154
UG-925B/U	46	UG-1094A/U	24	UG-1412/U	154
UG-926A/U	46	UG-1095B/U	77	UG-1413/U	154

Delta offers a full range of customizable services.

We encourage our customers to take the same white-board approach to their design considerations as we use. Whether it's an upfront design, a product update, performance enhancements, or fixing any irregularities, you can rely on Delta to adapt and offer solutions and specialized services. From modified dielectrics and pin lengths, to material and plating specifications, Delta works closely with our customers to fully, or partially, customize products and solutions. Our specialized services include passive intermodulation (PIM) optimization, as well as customization for medical, space or harsh environments. When customer requirements call for enhanced electrical and mechanical performance requirements, Delta delivers the difference.



We're Approachable

When we say we're approachable here at Delta, it means that our entire team is available to you from our drafters, application engineers, design engineers, and even the Director of Engineering, Bryan Miceli. Collaborating with our engineering team allows you to design with flexibility, whether it's a dimensional change to accommodate fit and interference to a complete augmented configuration in support of performance criteria, customization is seamless and easy at Delta. Can't find what you are looking for in our catalogs, please give us a call.

Virtual Design Review

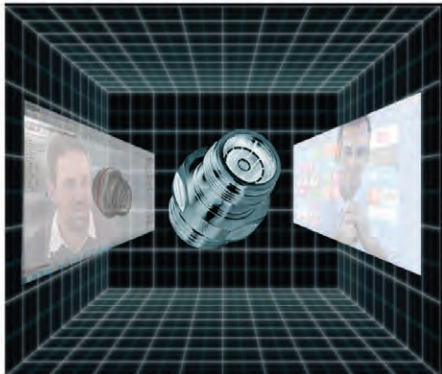

Application engineering, design consultation and collaboration, 2D and 3D modeling to ANSYS® HFSS models are the tools we use in our process to capture and propose a Virtual Design before move to the next phase. It allows you to provide the necessary back up data to support your decision making process. Let Delta take this on our shoulders.

Product Value Integration



Delta has the resources to provide a true value proposition for customers that are looking beyond interconnect. Vertical integration and flexible assembly and manufacturing allow Delta to think three dimensionally eliminating boundaries. From new machine implementation, to second tier operations such as integrated connector housings. Let Delta look deeper and help you implement Product Value Integration.

Verification to Validation

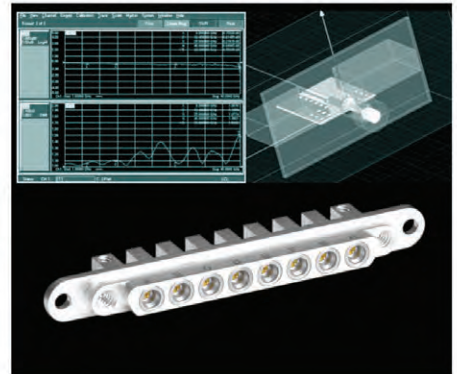

An order is not complete until customers have installed our products effectively. As part of the overall design process, we verify and validate. From review of application notes, to electrical, mechanical and environmental testing. Delta manages the process every step of the way. Experience the Delta Difference.

Definitions

Mating Ends and Body Styles

Plug: The connector in a mating pair which has the active mating mechanism (rotating coupling nut, spring lock, etc.).

Jack: The connector in a mating pair which has the passive mating mechanism (bayonet studs, grooves for spring locks, external threads, etc.).

Receptacle: A connector which is attached to a bulkhead, panel, or component housing and does not accept coaxial cable.

Dummy Receptacle: An empty receptacle body (no contact or insulator) used to secure a plug when the plug is not in use.

Resistive Termination (dummy load): A connector incorporating a resistor between the center contact and the outer body; used to simulate a load within a circuit.

Mounting Styles

Bulkhead mount: Threaded body for insertion through a single hole in a panel; secured by hex nut.

Panel mount: Square or rectangular flange, with mounting hole to secure flange to panel with screws, or with nuts and bolts.

PressMount: Round knurled body for mounting by pressing into a round hole in panel.

Note: "PLUG" or "JACK" should always be used to define mating end, not ___ contact gender— some series have female contacts in plugs and male contacts in jacks as the standard configuration.

Cable Connector Configuration Examples

Mating Ends and Body Styles



Straight cable plug

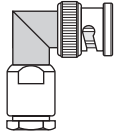

Right angle cable plug

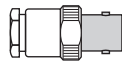

Straight cable jack

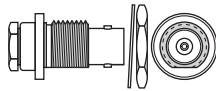

Bulkhead mount cable jack

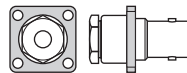

Panel mount cable jack

Cable Attachment Methods:

Refer to these assembly procedures for details of the specified cable attachment method.

Flexible Cables:

Crimp: See Assembly Procedure B.

Heli-Grip: See Assembly Procedure E.

MIL clamp: See Assembly Procedure A.

Semi-Rigid Cables:

Direct solder: See Assembly Procedure H.

Solder-clamp: See Assembly Procedure F.

Receptacle Configuration Examples

Mounting Styles

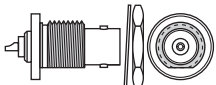

Bulkhead mount jack receptacle

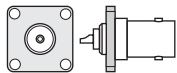

Panel mount jack receptacle

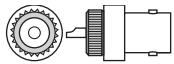

PressMount jack receptacle



Straight P.C. board jack receptacle

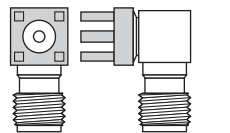

Right angle P.C. board jack receptacle

Contact Termination Styles

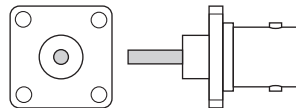

Post contact
(shown with extended insulator)

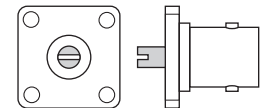

Slotted contact
(shown with flush insulator)

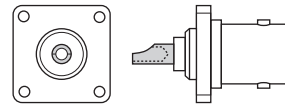

Solder pot contact
(shown with extended insulator)

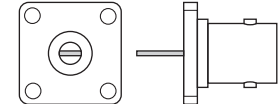

Tab contact
(shown with flush insulator)

Adapter Configuration Examples

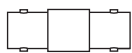

Straight jack-jack adapter

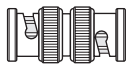

Straight plug-plug adapter

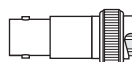

Straight jack-plug adapter

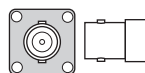

Straight jack-jack panel mount adapter

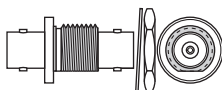

Straight jack-jack bulkhead mount adapter

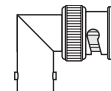

Right angle jack-plug adapter

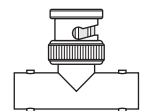

Tee adapter, jack-plug-jack



Create.
Collaborate.
Connect.

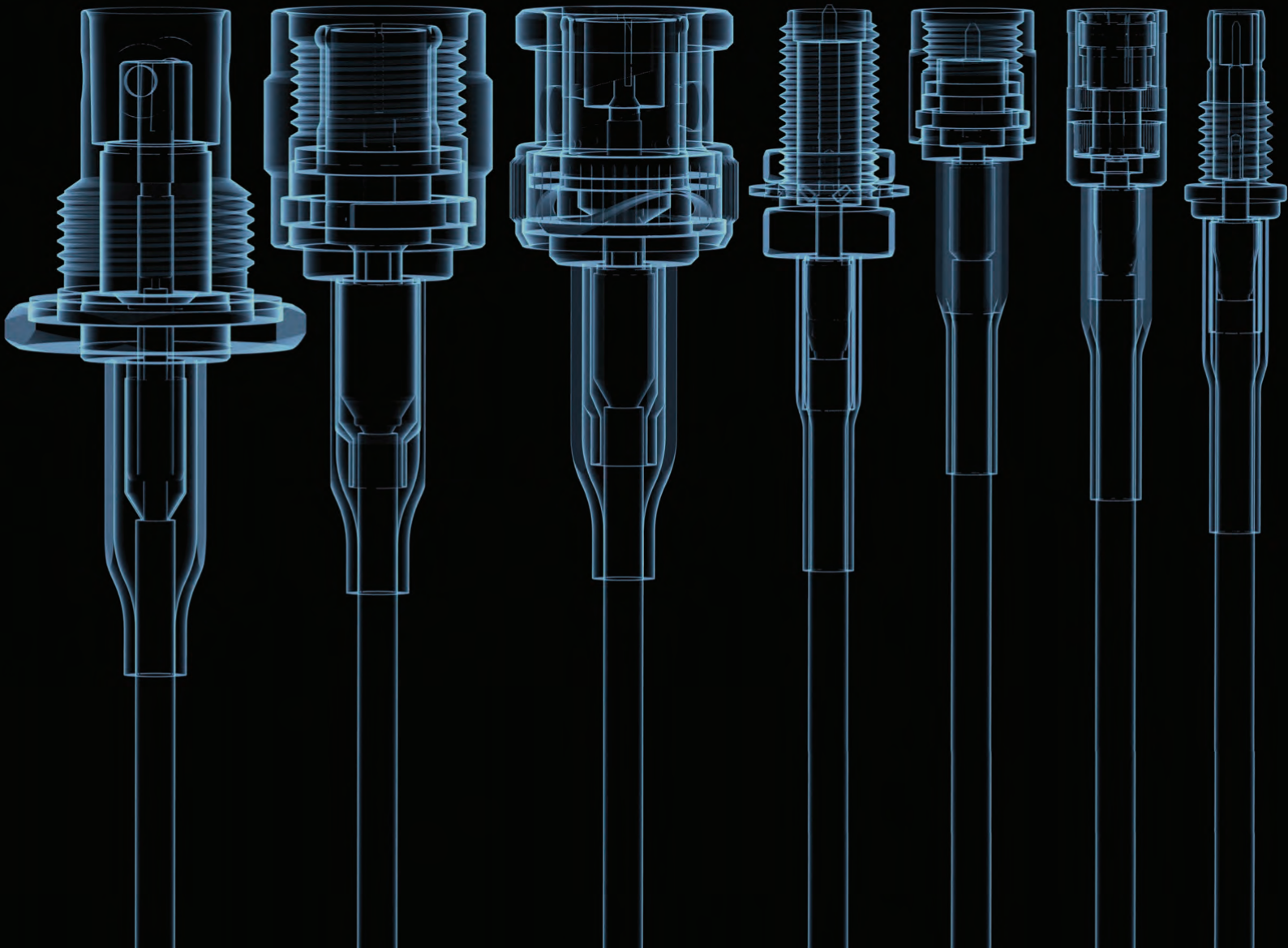

Experience the Delta Difference

Delta Electronics is a leading global provider of innovative RF, microwave and millimeter wave interconnect solutions. We're proud to deliver a world-class customer experience – what we call the Delta Difference – by focusing on four key areas: Purpose, Process, People, and Products/Solutions.



Purpose

The products we make keep people safe, connected, and informed every day, in every type of environment. Knowing that our work makes a difference to people in mission-critical situations around the world gives Delta a strong sense of purpose and pride that translates into exceptional customer service and ingenuity.



Process

For over 60 years, Delta has embraced advanced technologies and pioneered new approaches to precision manufacturing. Today, our process brings together lean manufacturing and vertical integration to ensure we have total control over manufacturing and the plating processes. This allows us to deliver truly customized solutions, while yielding significant cost-savings and quick turn to market.



People

We truly care about our customers, and take deep pride in finding creative solutions to their challenges. We invite all our customers to visit one of our facilities and meet the talented engineers and skilled craftspeople who set Delta apart from the crowd.



Products & Solutions

Delta offers a full range of RF, microwave and millimeter wave solutions that range from DC – 65 GHz and beyond, as well as customized solutions, including gang mounted interconnect permutations and connectorized integrated housings.

Our Markets

From avionics to audio, radar to robotics, Delta delivers precision interconnect and innovative solutions to a broad range of industries where reliability, performance, and durability are of paramount importance. Delta products are found in mission-critical systems across our nation's armed services, and platforms including homeland security, border control and NATO.

Aerospace

From take-off to landing, this high reliability market requires a higher degree of engineering and precision component solutions. Delta continues to evolve with these technologies because we know lives depend on our product.

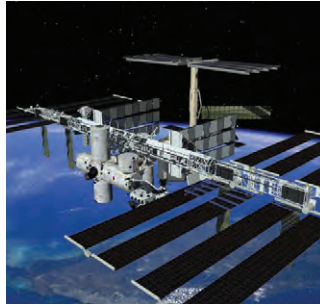

Broadcast/Audio

It's not what you see and hear, but how you see and hear it. From the newsroom to the classroom, the studio or your personal devices, and on any given Sunday, Delta connects.



Communications

Civil radios, military and commercial radar platforms, telecommunication and antenna technology. Delta creates innovative manufacturing solutions to support these critical applications.



Industrial

Renewable energy and nuclear power, automation, and robotics – Delta empowers innovation through creativity which allows Delta to innovate and collaborate with you.



Medical

Diagnostics, detection, imagery and implant devices require precise component design and development. Experience the care associated with how the Delta people collaborate.



Military

Mission-critical systems require the skill set to flex and diversify in an ever-changing field of operations. Delta's flexible manufacturing and assembly systems can change seamlessly, when needed.



Test/Masurement

Bench, production and general electrical test and measurement require precision adapters and test cables to quantify electrical performance. Let Delta evaluate your needs.



Transportation

Automotive, rail and shipboard communications require repetitive, unparalleled, uninterrupted service. This is what you can expect when engaging Delta. Experience the Delta Difference.



Our Capabilities

Delta offers true vertical integration transforming raw materials into fully finished product, including plating and assembly, on site. Having full control over all stages of the manufacturing processes allows us to provide our customers with the highest level of quality, and makes us agile, efficient, and highly adaptive. For our customers, this means cost effective, flexible manufacturing solutions in an ever-changing marketplace.

Our Services include:

- ▶ Application engineering
- ▶ Design consultation and collaboration
- ▶ 2D and 3D modeling
- ▶ ANSYS® HFSS models
- ▶ Precision CNC Turning and Milling
- ▶ Heat Treating
- ▶ Electroplating, passivation, pre-tinning
- ▶ Cable assemblies, transmission lines and related assemblies
- ▶ Integrated connectorized housings



Specialized Services

We encourage our customers to take the same white-board approach to their design considerations as we use. Whether it's an upfront design, a product update, performance enhancements, or fixing any irregularities, you can rely on Delta to adapt and offer solutions and specialized services. From modified dielectrics and pin lengths, to material and plating specifications, Delta works closely with our customers to fully, or partially, customize products and solutions. Our specialized services include passive intermodulation (PIM) optimization, as well as customization for medical, space or harsh environments. When customer requirements call for enhanced electrical and mechanical performance requirements, Delta delivers the difference.

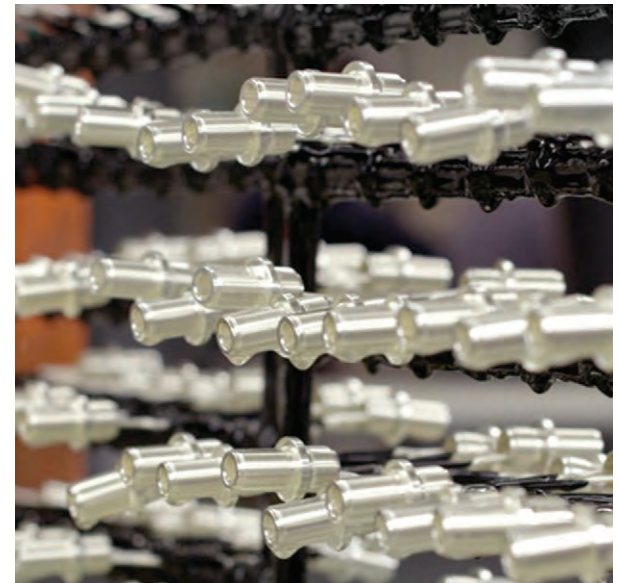

Frequency Spectrum

Delta offers a full range of interconnect products from DC – 65 GHz and beyond.



A US Company With Global Operations

Delta Electronic Manufacturing Corp.'s Global Headquarters in Beverly, MA is a vertically integrated manufacturing facility that features an automated plating line. Globally, Delta has a world-class manufacturing facility in Nanjing, China that mirrors our US manufacturing processes and equipment to ensure the highest quality and consistency of product. In addition, we have a strategic partnership in Taiwan that is also vertically integrated with its own plating line. Lean Manufacturing is the cornerstone of our operations worldwide.



USA Headquarters: Beverly MA

China: Nanjing

Taiwan: Kaohsiung



AS9100 / ISO9001
QMS CERTIFIED

DFARS
COMPLIANT

ROHS
COMPLIANT

ITAR
COMPLIANT

JCP
REGISTERED



978-927-1060



sales@deltarf.com



www.deltarf.com

Warranty

We warrant our parts to be free of defects and workmanship for one year from purchase. During that time we will repair or replace (at our option) any parts found to be defective. The warranty does not apply to parts that have been modified, used in conditions exceeding Seller's, or military specifications, or disassembled. We will not, under any circumstances, be responsible for consequential or incidental damages or installation costs. No other warranties apply, and no other liability may be assumed or extended by representatives or distributors. The terms of the applicable warranty or warranties, as the case may be, as set forth herein are the sole and exclusive warranty terms that shall have any force or effect in the any product order, resulting from the quotation and such terms and in lieu of all other warranties, expressed or implied, including the implied warranties of merchantability and fitness for a particular purpose, which are hereby expressly excluded.



Returns

Returns will be accepted only with a Return Authorization number issued by Delta, and are subject to inspection and acceptance upon arrival. Restocking charges will be determined prior to issuance of Return Authorization. All claims for shortages must be made within 30 days of receipt by customer.

Ordering Information

Orders are subject to the terms and conditions on our order acknowledgement, which may only be modified by written agreement prior to sale. Order changes, cancellation, or termination will be accepted only with written approval from Delta Electronics Manufacturing.

Copyright, Trademarks, & Patents

Entire contents copyright 2017, Delta Electronics Manufacturing Corporation. Reproduction rights are hereby granted for, and specifically limited to, printing or other reproduction of drawings and specifications for inclusion in specification or source control drawings, or purchasing procedures, by Delta customers only.

Heli-Grip[®], PressMount[®], and Global Manufacturer logo are trademarks. The Heli-Grip design is covered by U.S. and foreign patents

Delta Electronics Manufacturing Corporation
416 Cabot Street, P.O. Box 53
Beverly, MA 01915
FSCM/CAGE 00795



CREATE



COLLABORATE



CONNECT



Delta Electronics Mfg. Corp.

www.deltarf.com
978-927-1060
sales@deltarf.com

PO Box 53
416 Cabot St.
Beverly, MA 01915

