



DELTA
Electronics Mfg. Corp.



MIL-PRF-39012

QPL Connectors

MIL-PRF-55339

QPL Adapters

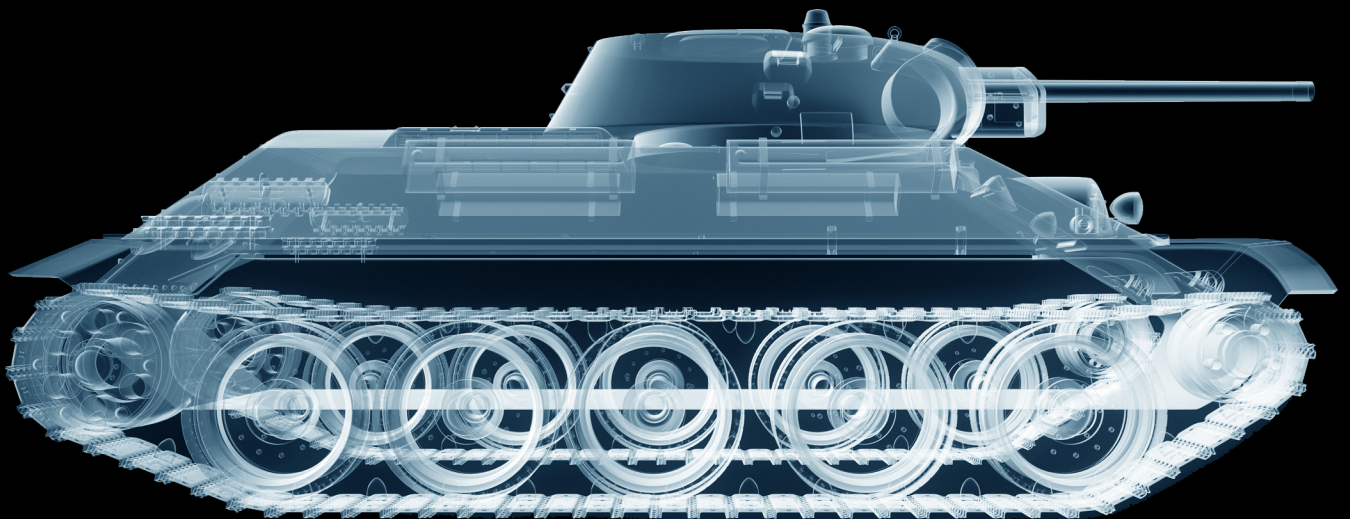

Experience The Delta Difference.



“Our Troops Depend On Delta.”



MIL-PRF-39012 & MIL-PRF-55339

M39012 Categories and Cable Groups

MIL-PRF-39012 QPL cable connectors are divided into categories which define the characteristics of their cable assembly method, and in some cases the actual assembly method:

Category A: Field-serviceable, with no special tools required for assembly. Our Category A connectors in series BNC, N, and TNC are standard military-clamp types; Category A connectors in SMA series are solder type.

Category B: Special tools may be required for assembly. Our Category B connectors in N series are crimp types which use standard, commercially-available crimp tools.

Category C: Crimp-type connectors which can be assembled with specified tools and die sizes.

Category D: Crimp-type connectors which can be assembled with specified tools and die sizes, and also have defined sizes for crimp sleeves, contacts, and other parts. Category D connectors have crimpable center contacts.

MIL-PRF-39012 Cable Groups

Group		Cables (M17/)
I		93-178,169-00001
II	IIA	113-RG316, 119-RG174, 173-00001, 172-00001, 196-00001
	IIB	94-RG179
III		152-00001
IV		54-RG122, 157-00001, 187-00001, 198-00001
V		95-RG180
VI	VIA	28-RG58, 111-RG303, 155-00001, 170-00001, 183-00001, 197-00001
	VIB	60-RG142, 84-RG223, 128-RG400, 158-00001, 167-00001, 175-00001, 194-00001, 200-00001
VII	VIIA	29-RG58, 30-RG62, 90-RG71, 97-RG210, 110-RG302, 184-00001, 185-00001
	VIIIB	90-RG71, 195-00001
VIII		2-RG6, 73-RG212, 112-RG304, 162-00001, 171-00001, 180-00001, 188-00001, 199-00001
X	XA	65-RG165, 74-RG213, 159-00001, 163-00001, 189-00001
	XB	75-RG214, 86-00001, 127-RG393, 164-00001, 174-00001, 190-00001
	XC	6-RG11, 62-RG144, 181-00001
	XD	77-RG216, 191-00001
XI		74-RG215, 189-00002
XII		78-RG217, 165-00001, 192-00001

MIL-PRF-39012 Cable Group Finder

Cable M17/	Category		Cable M17/	Category		Cable M17/	Category		Cable M17/	Category	
	A	B, C, D		A	B, C, D		A	B, C, D		A	B, C, D
2-RG6	VIII	VIII	90-RG71	VII	VIIIB	159-00001	X	XA	185-00001	VII	VIIA
6-RG11	X	XC	93-RG178	I	I	162-00001	VIII	VIII	187-00001	IV	IV
28-RG58	VI	VIA	94-RG179	II	IIB	163-00001	X	XA	188-00001	VIII	VIII
29-RG59	VII	VIIA	95-RG180	V	V	164-00001	X	XB	189-00001	X	XA
30-RG62	VII	VIIA	97-RG210	VII	VIIA	165-00001	XII	XII	189-00002	XI	—
54-RG122	IV	IV	110-RG302	VII	VIIA	167-00001	VI	VIB	190-00001	X	XB
60-RG142	VI	VIB	111-RG303	VI	VIA	169-00001	I	I	191-00001	X	XD
62-RG144	X	XC	112-RG304	VIII	VIII	170-00001	VI	VIA	192-00001	XII	XII
65-RG165	X	XA	113-RG316	II	IIA	171-00001	VIII	VIII	194-00001	VI	VIB
73-RG212	VIII	VIII	119-RG174	II	IIA	172-00001	II	IIA	196-00001	II	IIA
74-RG213	X	XA	127-RG393	X	XB	173-00001	II	IIA	197-00001	VI	VIA
74-RG215	XI	—	128-RG400	VI	VIB	174-00001	X	XB	198-00001	IV	IV
75-RG214	X	XB	133-RG316	II	IIA	175-00001	VI	VIB	199-00001	VIII	VIII
77-RG216	X	XD	152-00001	III	III	180-00001	VIII	VIII	200-00001	VI	VIB
78-RG217	XII	XII	155-00001	VI	VIA	181-00001	X	XC			
84-RG223	VI	VIB	157-00001	IV	IV	183-00001	VI	VIA			
86-00001	X	XB	158-00001	VI	VIB	184-00001	VII	VIIA			

M39012/16 BNC Straight Plug

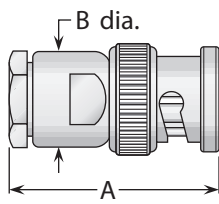

Figure 1

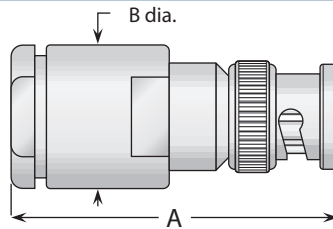

Figure 2

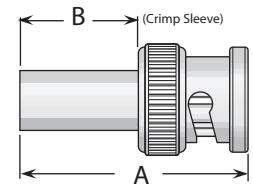

Figure 3

M39012 P/N	Category	Cable Group	Figure	Dimensions		Plating		Assembly Procedure/ Trim Code
				A	B	Body	Contact	
M39012/16-0013	C	VIA	3	1.13	.500	Silver	Gold (C)	B / 19
M39012/16-0014	C	VIB	3	1.13	.500	Silver	Gold (C)	B / 19
M39012/16-0015	C	VIIA	3	1.10	.500	Silver	Gold (C)	B / 19
M39012/16-0016	C	IV	3	1.13	.500	Silver	Gold (C)	B / 19
M39012/16-0017	C	VIIB	3	1.13	.500	Silver	Gold (C)	B / 19
M39012/16-0101	A	VI	1	1.06	.500	Silver	Gold (C)	A / 17
M39012/16-0102	A	VII	1	1.06	.500	Silver	Gold (C)	A / 17
M39012/16-0103	A	IV	1	1.06	.500	Silver	Gold (C)	A / 17
M39012/16-0111	A	VI	1	1.06	.500	Silver	Gold (C)	A / 17
M39012/16-0118	A	VII	1	1.06	.500	Silver	Gold (C)	A / 17
M39012/16-0220	A	II	1	1.06	.500	Silver	Gold (C)	A / 37
M39012/16-0222	A	II	3	.920	.307	Silver	Gold (C)	B / 19
M39012/16-0225	A	X	2	1.66	.750	Silver	Gold (C)	A / 01

M39012/17 BNC Straight Jack

&

M39012/18 BNC Panel Jack

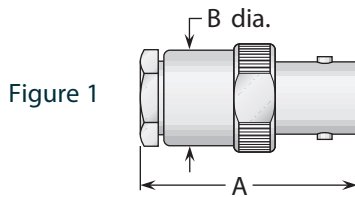
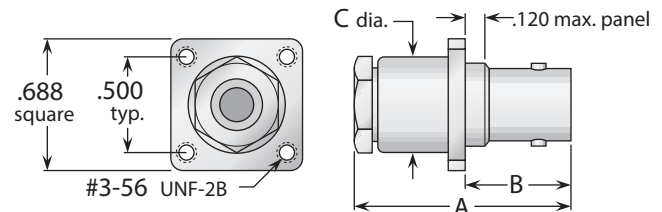

Figure 1

Figure 2



M39012 P/N	Category	Cable Group	Figure	Dimensions		Plating		Assembly Procedure/ Trim Code
				A	B	Body	Contact	
M39012/17-0101	A	VI	1	1.16	.50	Silver	Gold (C)	A / 17
M39012/17-0102	A	VII	1	1.16	.50	Silver	Gold (C)	A / 17
M39012/17-0103	A	IV	1	1.16	.50	Silver	Gold (C)	A / 17
M39012/17-0111	A	VI	1	1.16	.50	Silver	Gold (C)	A / 17
M39012/17-0118	A	VII	1	1.16	.50	Silver	Gold (C)	A / 17

M39012 P/N	Category	Cable Group	Figure	Dimensions			Plating		Assembly Procedure/ Trim Code
				A	B	C	Body	Contact	
M39012/18-0101	A	VII	2	1.16	.55	.50	Silver	Gold (C)	A / 17
M39012/18-0102	A	VI	2	1.16	.55	.50	Silver	Gold (C)	A / 17
M39012/18-0103	A	IV	2	1.16	.55	.50	Silver	Gold (C)	A / 17
M39012/18-0111	A	VI	2	1.16	.55	.50	Silver	Gold (C)	A / 17
M39012/18-0118	A	VII	2	1.16	.55	.50	Silver	Gold (C)	A / 17
M39012/18-0220	A	II	2	1.16	.55	.50	Silver	Gold (C)	A / 38

See page 2 for cable groups and category definitions. • Assembly procedures start on page 20. • (C) indicates captive contact.

M39012/19 BNC Bulkhead Jack

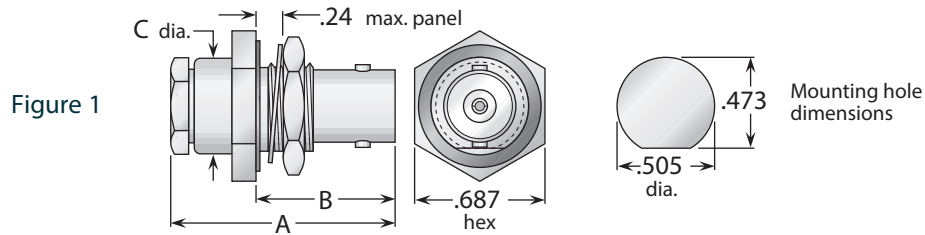

M39012 P/N	Category	Cable Group	Figure	Dimensions			Plating		Assembly Procedure/ Trim Code
				A	B	C	Body	Contact	
M39012/19-0101	A	VI	1	1.16	.81	.50	Silver	Gold (C)	A / 17
M39012/19-0102	A	VII	1	1.16	.81	.50	Silver	Gold (C)	A / 17
M39012/19-0110	A	IV	1	1.16	.81	.50	Silver	Gold (C)	A / 17
M39012/19-0111	A	VI	1	1.16	.81	.50	Silver	Gold (C)	A / 17
M39012/19-0118	A	VII	1	1.16	.81	.50	Silver	Gold (C)	A / 17
M39012/19-0220	A	II	1	1.16	.81	.50	Silver	Gold (C)	A / 17

M39012/20—BNC Right Angle Plug

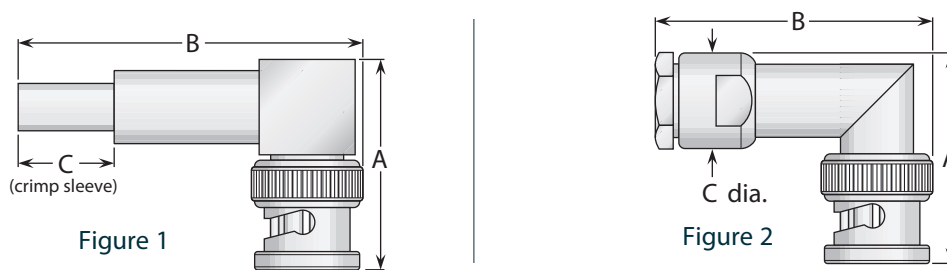

M39012 P/N	Category	Cable Group	Figure	Dimensions			Plating		Assembly Procedure/ Trim Code
				A	B	C	Body	Contact	
M39012/20-0006	C	VIA	1	1.07	1.63	.50	Silver	Gold (C)	B / 19
M39012/20-0007	C	VIB	1	1.07	1.63	.50	Silver	Gold (C)	B / 19
M39012/20-0101	A	VI	2	1.09	1.61	.50	Silver	Gold (C)	A / 17
M39012/20-0102	A	VII	2	1.09	1.61	.50	Silver	Gold (C)	A / 17
M39012/20-0108	A	VII	2	1.09	1.61	.50	Silver	Gold (C)	A / 17

M39012/21—BNC Bulkhead Receptacle

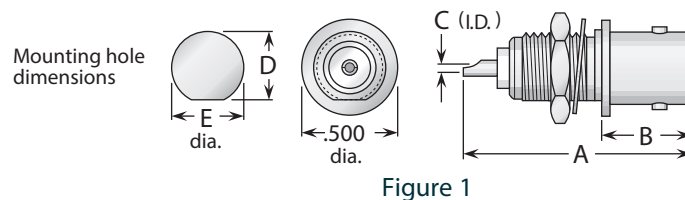

M39012 P/N	Figure	Dimensions					Maximum Panel	Plating	
		A	B	C	D	E		Body	Contact
M39012/21-0001	1	1.06	.49	.062	.410	.442	.13	Silver	Gold (C)
M39012/21-0002	1	1.19	.47	.062	.348	.380	.26	Silver	Gold (C)
M39012/21-0003	1	1.19	.47	.062	.410	.442	.26	Silver	Gold (C)

See page 2 for cable groups and category definitions. • Assembly procedures start on page 20. • (C) indicates captive contact.

M39012/22 - BNC Panel Receptacle

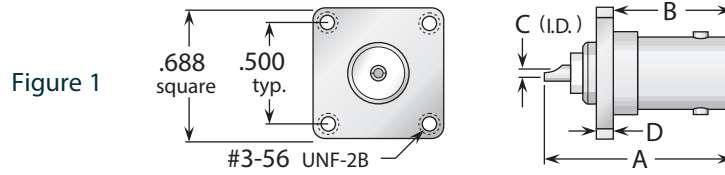

M39012 P/N	Figure	Dimensions				Maximum Panel	Plating	
		A	B	C	D		Body	Contact
M39012/22-0001	1	1.06	.63	.062	.090	.149	Silver	Gold (C)

M39012/24 - BNC Bulkhead Receptacle (Hermetically Sealed)

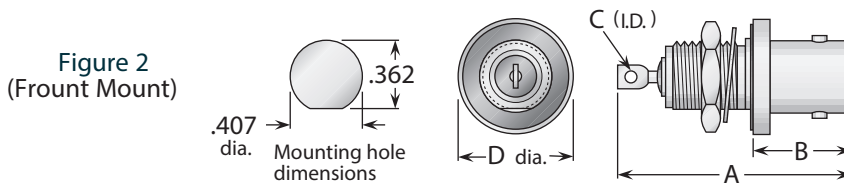
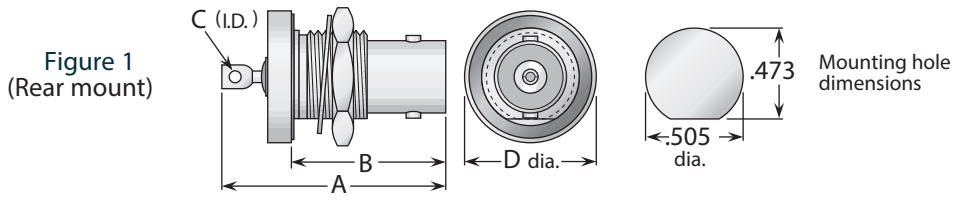

M39012 P/N	Figure	Dimensions				Maximum Panel	Plating	
		A	B	C	D		Body	Contact
M39012/24-0001	1	1.20	.83	.062	.687	.26	Silver	Gold (C)
M39012/24-0002	2	1.20	.52	.062	.594	.26	Silver	Gold (C)

M39012/25 - BNC Dust Caps

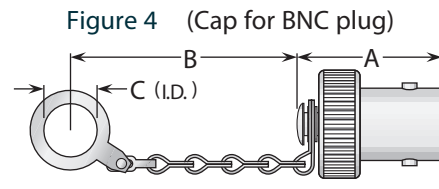
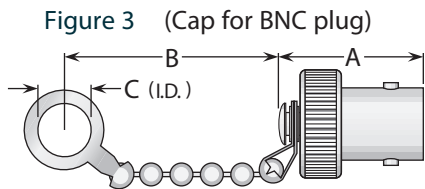
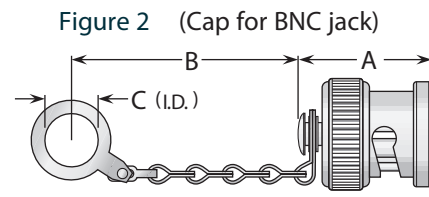
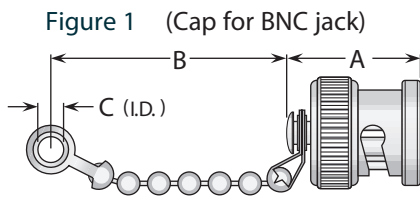

M39012 P/N	Figure	Dimensions			Chain Type	Plating	
		A	B	C		Body	Contact
M39012/25-0006	1	.67	2.25	.144	Bead	Silver	—
M39012/25-0007	2	.67	2.70	.52	Safety	Silver	—
M39012/25-0008	3	.69	3.25	.281	Bead	Silver	—
M39012/25-0009	4	.69	3.25	.281	Safety	Silver	—

(C) indicates captive contact.

M55339—BNC Adapters Within Series

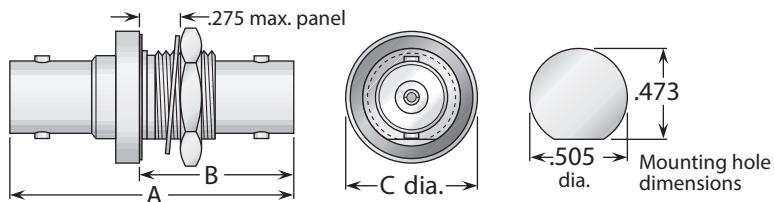

Figure 1 (Bulkhead mounted jack-jack, hermetically sealed)

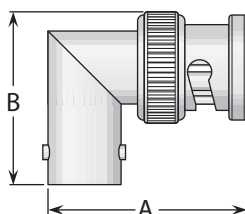

Figure 2
(Right angle jack-plug)

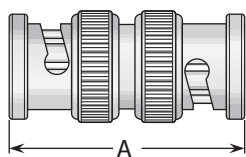

Figure 3 (Straight plug-plug)

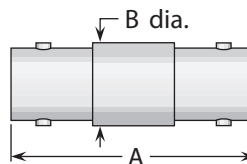

Figure 4 (Straight jack-jack)

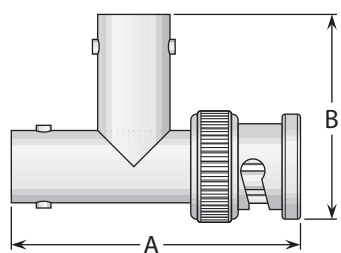

Figure 5 (Tee, jack-jack-plug)

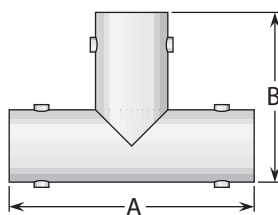

Figure 6 (Tee, jack-jack-jack)

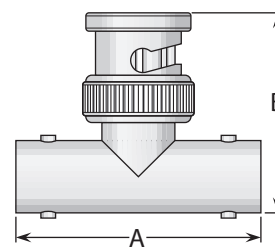
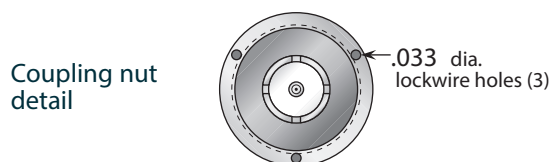
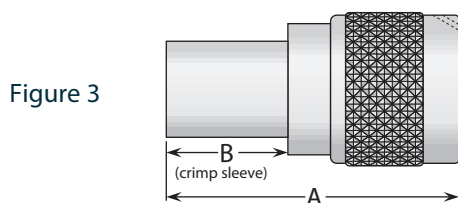
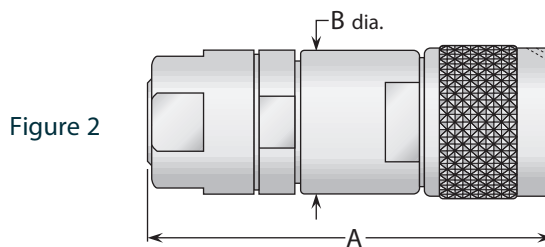
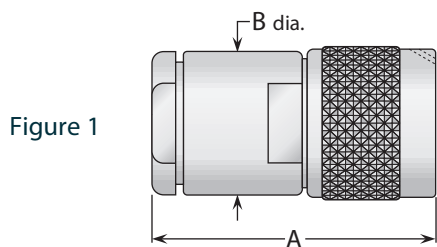

Figure 7 (Tee, jack-plug-jack)

M55339 P/N	Figure	Dimensions			Plating	
		A	B	C	Body	Contact
M55339/13-00492	1	1.53	.86	.69	Silver	Gold (C)
M55339/14-00306	2	1.06	.88	—	Silver	Gold (C)
M55339/15-00491	3	1.22	—	—	Silver	Gold (C)
M55339/16-00914	4	1.28	.44	—	Silver	Gold (C)
M55339/17-00001	5	1.50	1.06	—	Silver	Gold (C)
M55339/17-00002	6	1.28	.97	—	Silver	Gold (C)
M55339/17-00274	7	1.28	1.03	—	Silver	Gold (C)

(C) indicates captive contact.

M39012/01—N Straight Plug



M39012 P/N	Category	Cable Group	Figure	Dimensions		Plating		Assembly Procedure/ Trim Code
				A	B	Body	Contact	
M39012/01-0005	A	X	1	1.50	.750	Silver	Gold (C)	A / 01
M39012/01-0015	A	XII	1	1.80	.880	Silver	Gold (C)	A / 01
M39012/01-0016	C	VIII	3	2.00	.781	Silver	Gold (C)	B / 03
M39012/01-0017	C	XA	3	2.00	.781	Silver	Gold (C)	B / 03
M39012/01-0018	C	XB	3	2.00	.781	Silver	Gold (C)	B / 03
M39012/01-0023	C	XC	3	2.00	.781	Silver	Gold (C)	B / 03
M39012/01-0024	C	XD	3	1.55	.781	Silver	Gold (C)	B / 03
M39012/01-0125	A	XI	2	2.42	.750	Silver	Gold (C)	Contact Factory
M39012/01-0501	D	XB	3	1.55	.600	Silver	Gold (C)	B / 03
M39012/01-0502	D	XA	3	1.55	.600	Silver	Gold (C)	B / 03
M39012/01-0503	D	VIB	3	1.45	.500	Silver	Gold (C)	B / 03
M39012/01B0007	B	XA	3	1.55	.600	Silver	Gold (C)	B / 03
M39012/01B0008	B	XB	3	1.55	.600	Silver	Gold (C)	B / 03

M39012/02 - N Straight Jack

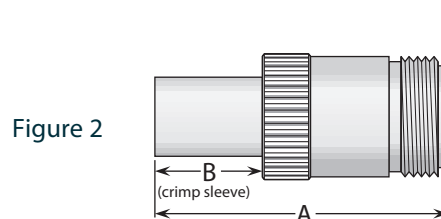
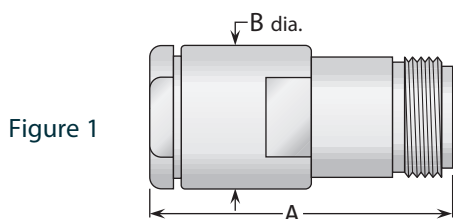

M39012 P/N	Category	Cable Group	Figure	Dimensions		Plating		Assembly Procedure/ Trim Code
				A	B	Body	Contact	
M39012/02-0003	A	X	1	1.67	.75	Silver	Gold (C)	A / 01
M39012/02-0101	A	VIII	1	1.67	.75	Silver	Gold (C)	A / 01
M39012/02-0501	D	XB	2	1.64	.60	Silver	Gold (C)	B / 03
M39012/02-0502	D	XA	2	1.64	.60	Silver	Gold (C)	B / 03
M39012/02-0503	D	VIB	2	1.54	.50	Silver	Gold (C)	B / 03
M39012/02B0008	B	XA	2	1.64	.60	Silver	Gold	B / 10
M39012/02B0009	B	XB	2	1.64	.60	Silver	Gold	B / 10

See next page for panel-mounted M39012/02 cable jacks.

See page 2 for cable groups and category definitions. • Assembly procedures start on page 20. • (C) indicates captive contact.

M39012/02—N Panel Jack

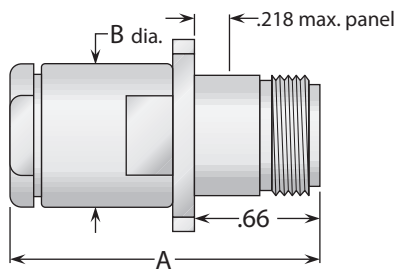

Figure 1

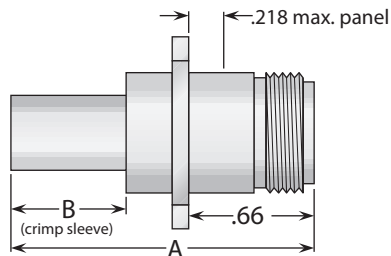
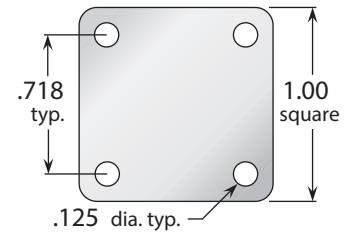

Figure 2



Flange Dimensions

M39012 P/N	Category	Cable Group	Figure	Dimensions		Plating		Assembly Procedure/ Trim Code
				A	B	Body	Contact	
M39012/02-0006	A	X	1	1.67	.75	Silver	Gold (C)	A / 01
M39012/02-0104	A	VIII	1	1.67	.75	Silver	Gold (C)	A / 01
M39012/02-0511	D	XB	2	1.64	.60	Silver	Gold (C)	B / 03
M39012/02-0512	D	XA	2	1.64	.60	Silver	Gold (C)	B / 03
M39012/02-0513	D	VIB	2	1.54	.50	Silver	Gold (C)	B / 03

M39012/03—N Bulkhead Jack

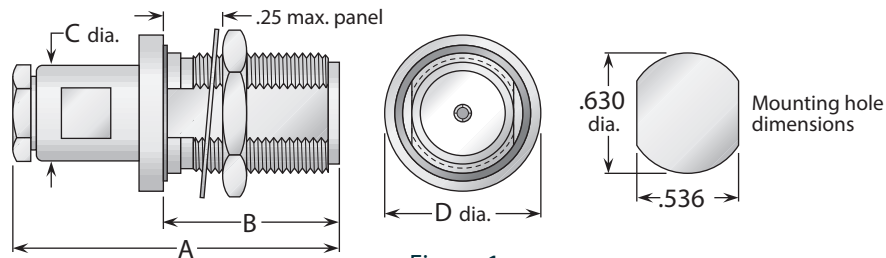

Figure 1

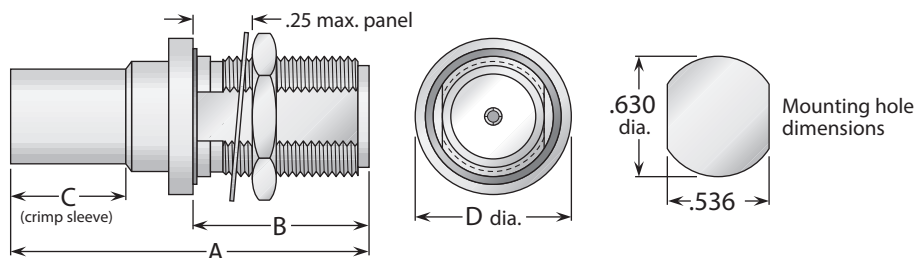

Figure 2

M39012 P/N	Category	Cable Group	Figure	Dimensions				Plating		Assembly Procedure/ Trim code
				A	B	C	D	Body	Contact	
M39012/03-0101	A	VIII	1	1.75	.92	.75	.900	Silver	Gold (C)	A / 01
M39012/03-0102	A	XII	1	1.90	.92	.88	.875	Silver	Gold (C)	A / 01
M39012/03-0501	D	XB	2	1.84	.92	.60	.875	Silver	Gold (C)	B / 03
M39012/03-0502	D	XA	2	1.84	.92	.60	.875	Silver	Gold (C)	B / 03
M39012/03-0503	D	VIB	2	1.74	.92	.50	.875	Silver	Gold (C)	B / 03
M39012/03B0004	B	XA	2	1.84	.92	.60	.875	Silver	Gold (C)	B / 03
M39012/03B0005	B	XB	2	1.84	.92	.60	.875	Silver	Gold (C)	B / 03

See page 2 for cable groups and category definitions. • Assembly procedures start on page 20. • (C) indicates captive contact.

M39012/04 - N Receptacles

Figure 1 (Bulkhead jack, hermetically sealed)

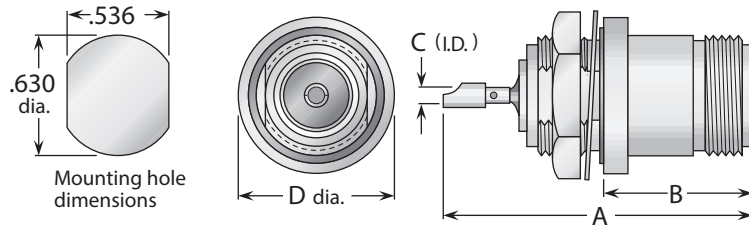
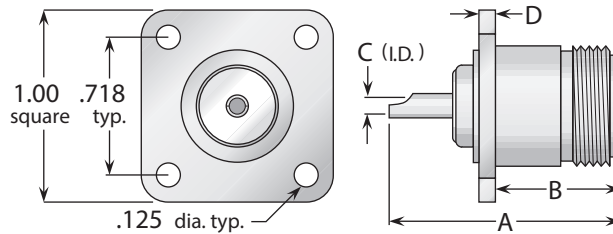

Figure 2 (Panel jack)



M39012 P/N	Figure	Dimensions				Maximum Panel	Plating	
		A	B	C	D		Body	Contact
M39012/04-0001	1	1.62	.707	.099	.812	.100	Silver	Gold (C)
M39012/04-0002	2	1.13	.660	.100	.080	.110	Silver	Gold (C)

M39012/05 - N Right Angle Plug

Figure 1

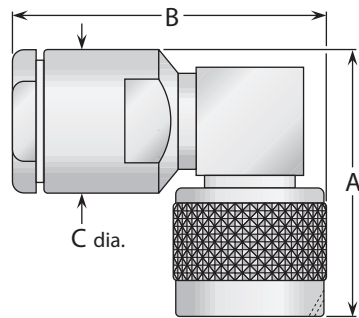

Coupling nut detail

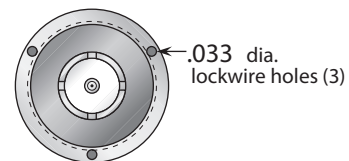

M39012 P/N	Category	Cable Group	Figure	Dimensions			Plating		Assembly Procedure/ Trim Code
				A	B	C	Body	Contact	
M39012/05-0101	A	X	1	1.36	1.66	.75	Silver	Gold (C)	A / 07

M39012/25 - N Dust Caps

Figure 1 (Cap for N jack)

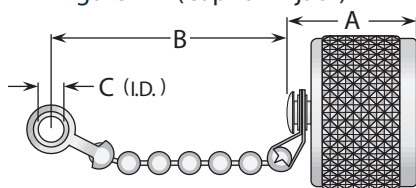
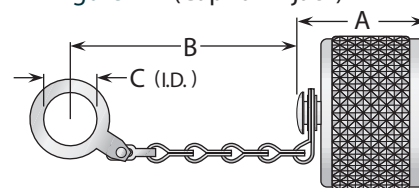

Figure 2 (Cap for N jack)



M39012 P/N	Figure	Dimensions			Chain Type	Plating	
		A	B	C		Body	Contact
M39012/25-0011	1	.56	2.50	.144	Bead	Silver	—
M39012/25-0012	2	.56	3.75	.635	Safety	Silver	—

See page 2 for cable groups and category definitions. • Assembly procedures start on page 20. • (C) indicates captive contact.

M55339—N Adapters Within Series

Figure 1
(Right angle jack-plug)

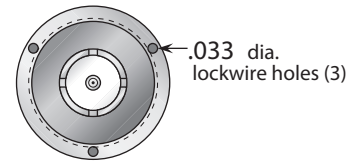
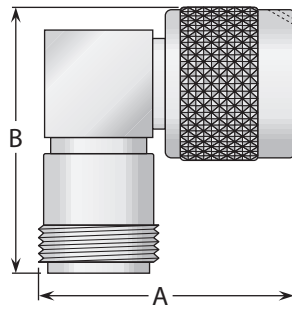

Coupling nut detail
(For figures 1, 3, and 4)

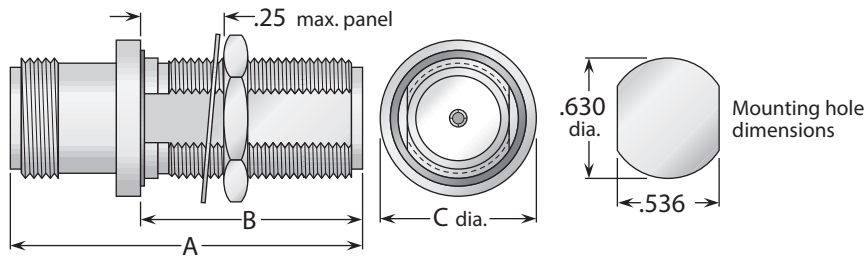

Figure 2 (Bulkhead mounted jack-jack, hermetically sealed)

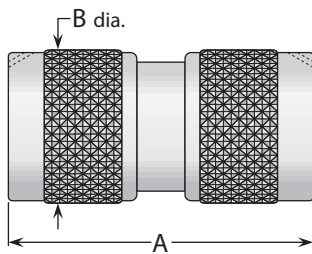

Figure 3
(Straight plug-plug)

Figure 4
(Tee, jack-plug-jack)

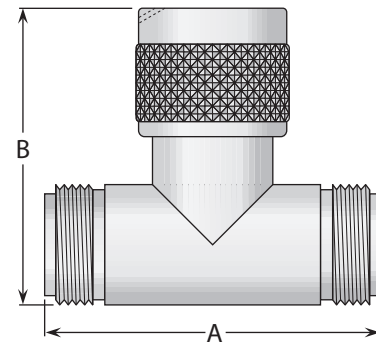

Figure 5
(Tee, jack-jack-jack)

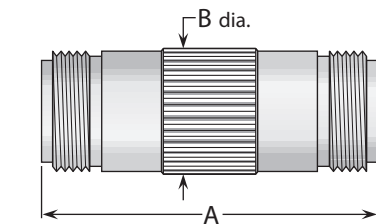
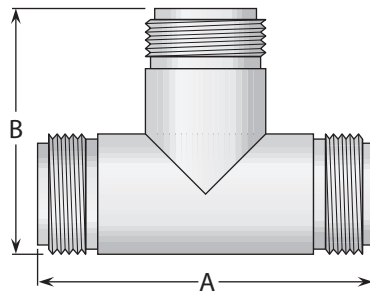
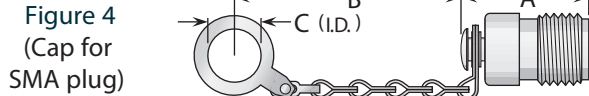
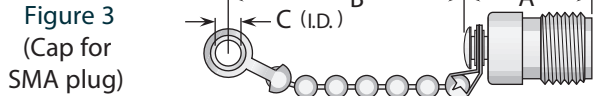
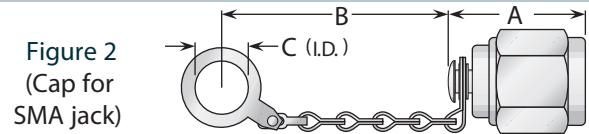
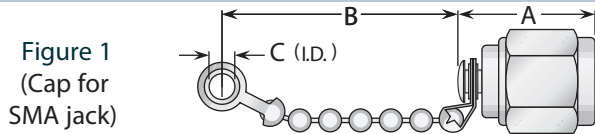

Figure 6 (Straight jack-jack)

M55339 P/N	Figure	Dimensions			Plating	
		A	B	C	Body	Contact
M55339/03-00027	1	1.30	1.38	—	Silver	Gold (C)
M55339/04-00030	2	1.54	.86	.875	Silver	Gold (C)
M55339/05-00057	3	1.59	—	—	Silver	Gold (C)
M55339/06-00001	4	1.75	1.47	—	Silver	Gold (C)
M55339/06-00028	5	1.75	1.22	—	Silver	Gold (C)
M55339/07-00029	6	1.75	.66	—	Silver	Gold (C)

(C) indicates captive contact.

M39012/25- SMA Dust Caps



M39012 P/N	Figure	Dimensions			Chain Type	Plating	
		A	B	C		Body	Contact
M39012/25-3024	1	.50	2.25	.144	Bead	Passivated	—
M39012/25-3025	2	.50	3.25	.281	Safety	Passivated	—
M39012/25-3026	3	.50	3.25	.144	Bead	Passivated	—
M39012/25-3027	4	.50	3.25	.281	Safety	Passivated	—

M39012/55—SMA Straight Plug

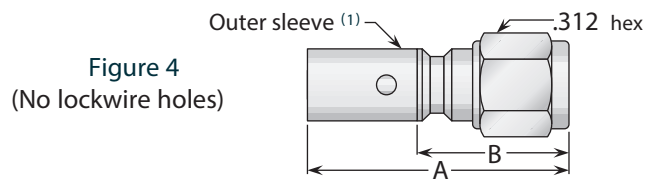
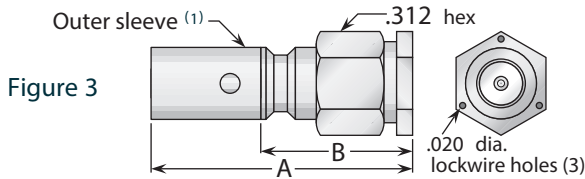
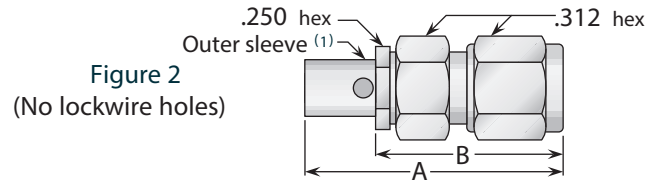
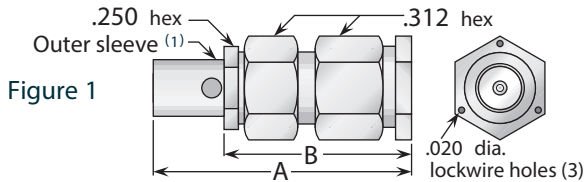

M39012 P/N	Category	Cable Group	Figure	Dimensions		Plating		Assembly Procedure/ Trim Code
				A	B	Body	Contact	
M39012/55-3006	A	I	1	.91	.67	Gold (2)	Gold (C)	M / 01
M39012/55-3007	A	II	1	.91	.67	Gold (2)	Gold (C)	M / 01
M39012/55-3008	A	IV	3	.94	.57	Gold (2)	Gold (C)	K / 12
M39012/55-3009	A	VI	3	.94	.57	Gold (2)	Gold (C)	K / 12
M39012/55-3025	C	I	1	.91	.67	Passivated	Gold (C)	M / 01
M39012/55-3026	C	IIA	1	.97	.67	Passivated	Gold (C)	M / 01
M39012/55-3027	C	IV	3	.94	.57	Passivated	Gold (C)	K / 12
M39012/55-3028	C	VIB	3	.95	.57	Passivated	Gold (C)	K / 12
M39012/55-3029	C	VIA	3	.97	.57	Passivated	Gold (C)	K / 12
M39012/55-3030	A	III	1	.91	.67	Gold (2)	Gold (C)	M / 01
M39012/55-3106	A	I	2	.91	.67	Gold (2)	Gold (C)	M / 01
M39012/55-3107	A	II	2	.91	.67	Gold (2)	Gold (C)	M / 01
M39012/55-3108	A	IV	4	.94	.57	Gold (2)	Gold (C)	K / 12
M39012/55-3109	A	VI	4	.94	.57	Gold (2)	Gold (C)	K / 12
M39012/55-3125	C	I	2	.91	.67	Passivated	Gold (C)	M / 01
M39012/55-3126	C	IIA	2	.97	.57	Passivated	Gold (C)	M / 01
M39012/55-3127	C	IV	4	.94	.57	Passivated	Gold (C)	K / 12
M39012/55-3128	C	VIB	4	.95	.57	Passivated	Gold (C)	K / 12
M39012/55-3129	C	VIA	4	.97	.57	Passivated	Gold (C)	K / 12
M39012/55-3130	A	III	2	.91	.67	Gold (2)	Gold (C)	M / 01

(1) Category A: Solder sleeve with access hole as shown; Category C: Crimp sleeve without access hole.
 (2) Coupling nut is passivated; body tail is gold plated for soldering of cable braid.

See page 2 for cable groups and category definitions. • Assembly procedures start on page 20. • (C) indicates captive contact.

M39012/55—SMA Straight Plug - Continued

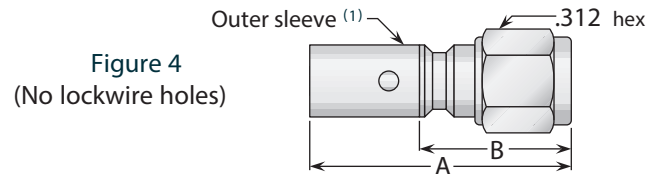
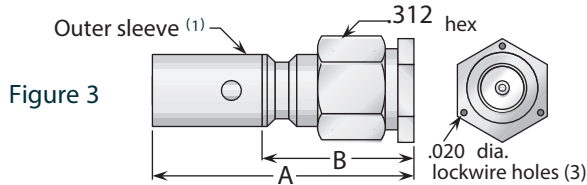
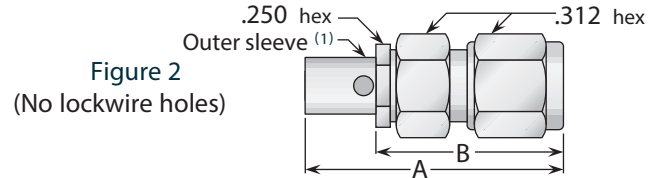
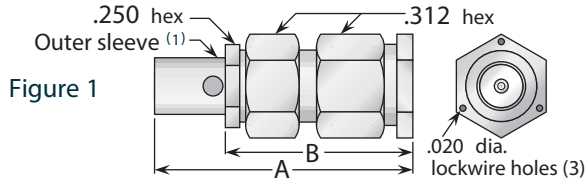

M39012 P/N	Category	Cable Group	Figure	Dimensions		Plating		Assembly Procedure/ Trim Code
				A	B	Body	Contact	
M39012/55-4006	A	I	1	1.25	.67	Gold ⁽³⁾	Gold (C)	M/01
M39012/55-4007	A	II	1	1.25	.67	Gold ⁽³⁾	Gold (C)	M/01
M39012/55-4008	A	IV	1	1.25	.67	Gold ⁽³⁾	Gold (C)	K/12
M39012/55-4009	A	VI	3	.94	.568	Gold ⁽³⁾	Gold (C)	K/12
M39012/55-4030	A	III	3	.94	.568	Gold ⁽³⁾	Gold (C)	M/01
M39012/55-4106	A	I	2	1.25	.67	Gold ⁽³⁾	Gold (C)	M/01
M39012/55-4107	A	II	2	1.25	.67	Gold ⁽³⁾	Gold (C)	M/01
M39012/55-4108	A	IV	4	.94	.568	Gold ⁽³⁾	Gold (C)	K/12
M39012/55-4109	A	VI	4	.94	.568	Gold ⁽³⁾	Gold (C)	K/12
M39012/55-4130	A	III	4	.94	.568	Gold ⁽³⁾	Gold (C)	M/01

(1) Category A: Solder sleeve with access hole as shown; Category C: Crimp sleeve without access hole.

(2) Coupling nut is passivated; body tail is gold plated for soldering of cable braid.

(3) All material is Beryllium Copper and Gold Plated.

•Assembly procedures start on page 20.

•See page 2 for cable groups and categories.

M39012/56- SMA Right Angle Plug

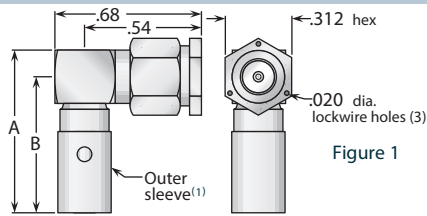

Figure 1

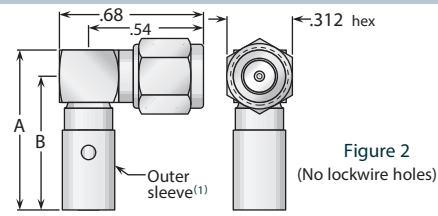

Figure 2
(No lockwire holes)

M39012 P/N	Category	Cable Group	Figure	Dimensions		Plating		Assembly Procedure/ Trim Code
				A	B	Body	Contact	
M39012/56-3006	A	I	1	.68	.55	Gold ⁽²⁾	Gold (C)	L / 06
M39012/56-3007	A	II	1	.68	.55	Gold ⁽²⁾	Gold (C)	L / 06
M39012/56-3008	A	IV	1	.76	.63	Gold ⁽²⁾	Gold (C)	L / 01
M39012/56-3009	A	VI	1	.76	.63	Gold ⁽²⁾	Gold (C)	L / 01
M39012/56-3025	C	I	1	.68	.55	Passivated	Gold (C)	L / 06
M39012/56-3026	C	IIA	1	.74	.61	Passivated	Gold (C)	L / 06
M39012/56-3027	C	IV	1	.68	.55	Passivated	Gold (C)	L / 06
M39012/56-3028	C	VIB	1	.69	.56	Passivated	Gold (C)	L / 06
M39012/56-3029	C	VIA	1	.71	.58	Passivated	Gold (C)	L / 06
M39012/56-3030	A	III	1	.68	.55	Gold ⁽²⁾	Gold (C)	L / 06
M39012/56-3106	A	I	2	.68	.55	Gold ⁽²⁾	Gold (C)	L / 06
M39012/56-3107	A	II	2	.68	.55	Gold ⁽²⁾	Gold (C)	L / 06
M39012/56-3108	A	IV	2	.76	.63	Gold ⁽²⁾	Gold (C)	L / 01
M39012/56-3109	A	VI	2	.76	.63	Gold ⁽²⁾	Gold (C)	L / 01
M39012/56-3125	C	I	2	.68	.55	Passivated	Gold (C)	L / 06
M39012/56-3126	C	IIA	2	.74	.61	Passivated	Gold (C)	L / 06
M39012/56-3127	C	IV	2	.68	.55	Passivated	Gold (C)	L / 06
M39012/56-3128	C	VIB	2	.69	.56	Passivated	Gold (C)	L / 06
M39012/56-3129	C	VIA	2	.71	.58	Passivated	Gold (C)	L / 06
M39012/56-3130	A	III	2	.68	.55	Gold ⁽²⁾	Gold (C)	L / 06
M39012/56-3502	D	XA	1	1.13	1.01	Passivated	Gold (C)	B / 40
M39012/56-3602	D	XA	2	1.13	1.01	Gold ⁽³⁾	Gold (C)	B / 40
M39012/56-4502	D	XA	1	1.13	1.01	Passivated	Gold (C)	B / 40
M39012/56-4602	D	XA	2	1.13	1.01	Gold ⁽³⁾	Gold (C)	B / 40

(1) (2) (3) See page 12 for notes.

M39012/57—SMA Straight Jack

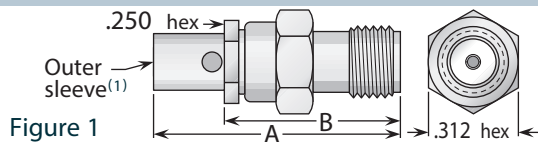

Figure 1

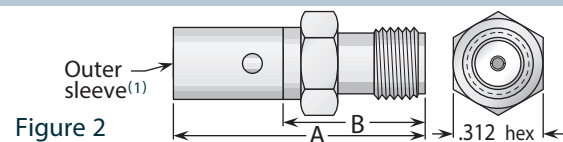
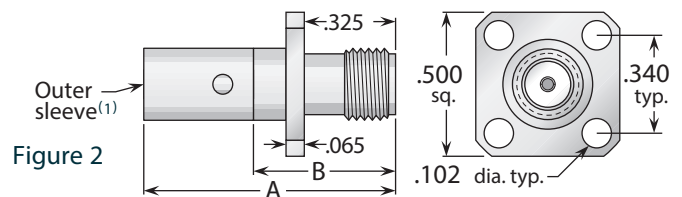
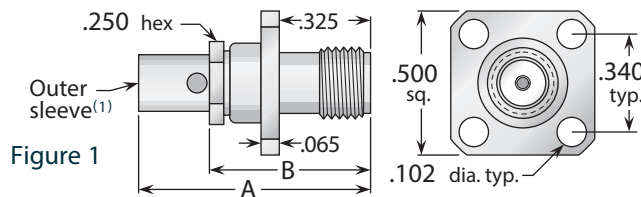

Figure 2

M39012 P/N	Category	Cable Group	Figure	Dimensions		Plating		Assembly Procedure/ Trim Code
				A	B	Body	Contact	
M39012/57-3006	A	I	1	.87	.63	Gold ⁽²⁾	Gold (C)	M / 01
M39012/57-3007	A	II	1	.87	.63	Gold ⁽²⁾	Gold (C)	M / 01
M39012/57-3008	A	IV	2	.90	.53	Gold	Gold (C)	K / 12
M39012/57-3009	A	VI	2	.90	.53	Gold	Gold (C)	K / 12
M39012/57-3025	C	I	1	.87	.63	Passivated	Gold (C)	M / 01
M39012/57-3026	C	IIA	1	.93	.63	Passivated	Gold (C)	M / 01
M39012/57-3027	C	IV	2	.91	.53	Passivated	Gold (C)	K / 12
M39012/57-3028	C	VIB	2	.91	.53	Passivated	Gold (C)	K / 12
M39012/57-3029	C	VIA	2	.93	.53	Passivated	Gold (C)	K / 12
M39012/57-3030	A	III	1	.87	.63	Gold ⁽²⁾	Gold (C)	M / 01
M39012/57-4007	A	II	1	.96	.63	Gold ⁽³⁾	Gold (C)	M / 01

(1) (2) (3) See page 12 for notes. • See page 2 for cable groups and category and definitions. • Assembly procedures start on page 20. • (C) indicates captive contact.

M39012/58—SMA Panel Jack



M39012 P/N	Category	Cable Group	Figure	Dimensions		Plating		Assembly Procedure/ Trim Code
				A	B	Body	Contact	
M39012/58-3006	A	I	1	.87	.63	Gold ⁽²⁾	Gold (C)	M / 01
M39012/58-3007	A	II	1	.87	.63	Gold ⁽²⁾	Gold (C)	M / 01
M39012/58-3008	A	IV	2	.90	.53	Gold	Gold (C)	K / 12
M39012/58-3009	A	VI	2	.90	.53	Gold	Gold (C)	K / 12
M39012/58-3025	C	I	1	.87	.63	Passivated	Gold (C)	M / 01
M39012/58-3026	C	IIA	1	.93	.63	Passivated	Gold (C)	M / 01
M39012/58-3027	C	IV	2	.91	.53	Passivated	Gold (C)	K / 12
M39012/58-3028	C	VIB	2	.91	.53	Passivated	Gold (C)	K / 12
M39012/58-3029	C	VIA	2	.93	.53	Passivated	Gold (C)	K / 12
M39012/58-3030	A	III	1	.87	.63	Gold ⁽²⁾	Gold (C)	M / 01

M39012/59—SMA Bulkhead Jack

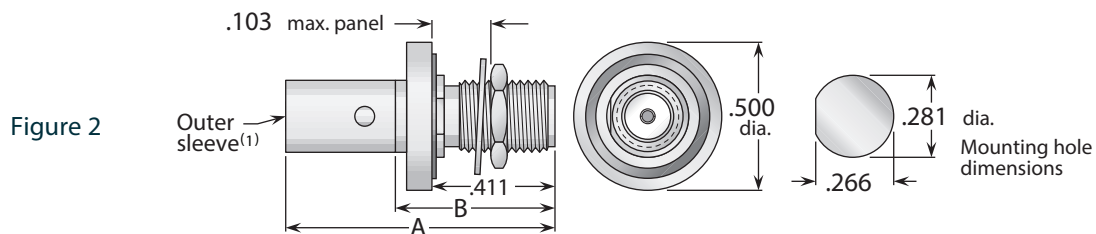
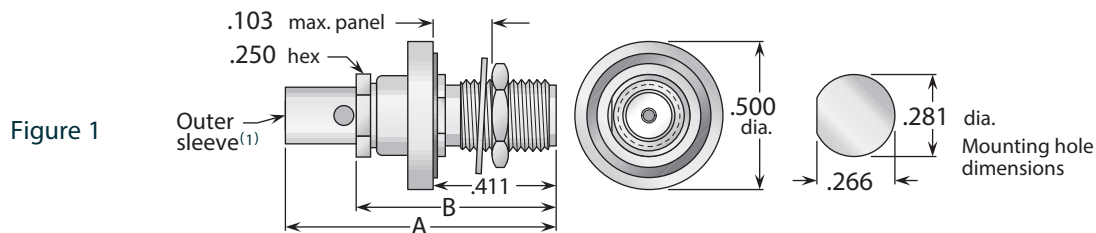

M39012 P/N	Category	Cable Group	Figure	Dimensions		Plating		Assembly Procedure/ Trim Code
				A	B	Body	Contact	
M39012/59-3006	A	I	1	.87	.63	Gold ⁽²⁾	Gold (C)	M / 01
M39012/59-3007	A	II	1	.87	.63	Gold ⁽²⁾	Gold (C)	M / 01
M39012/59-3008	A	IV	2	.90	.53	Gold	Gold (C)	K / 12
M39012/59-3009	A	VI	2	.90	.53	Gold	Gold (C)	K / 12
M39012/59-3025	C	I	1	.87	.63	Passivated	Gold (C)	M / 01
M39012/59-3026	C	IIA	1	.93	.63	Passivated	Gold (C)	M / 01
M39012/59-3027	C	IV	2	.91	.53	Passivated	Gold (C)	K / 12
M39012/59-3028	C	VIB	2	.91	.53	Passivated	Gold (C)	K / 12
M39012/59-3029	C	VIA	2	.93	.53	Passivated	Gold (C)	K / 12
M39012/59-3030	A	III	1	.87	.63	Gold ⁽²⁾	Gold (C)	M / 01
M39012/59-4009	A	IV	2	.96	.53	Gold ⁽³⁾	Gold (C)	K / 12

⁽¹⁾ Category A: Solder sleeve with access hole as shown; Category C: Crimp sleeve without access hole.

⁽²⁾ Mating thread area is passivated; body tail is gold plated for soldering of cable braid.

⁽³⁾ All Material is Beryllium Copper and Gold plated.

See page 2 for cable groups and category definitions. • Assembly procedures start on page 20. • (C) indicates captive contact.

M39012/60—SMA Panel Jack Receptacle

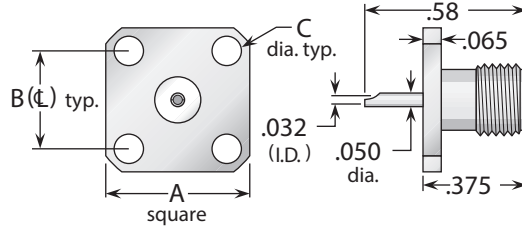

Figure 1

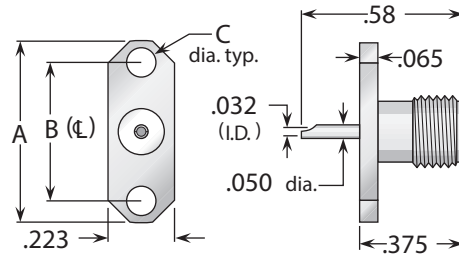

Figure 2

M39012 P/N	Figure	Dimensions			Plating	
		A	B	C	Body	Contact
M39012/60-3001	1	.500	.340	.102	Passivated	Gold (C)
M39012/60-3002	2	.625	.481	.102	Passivated	Gold (C)

M39012/61—SMA Bulkhead Jack Receptacle

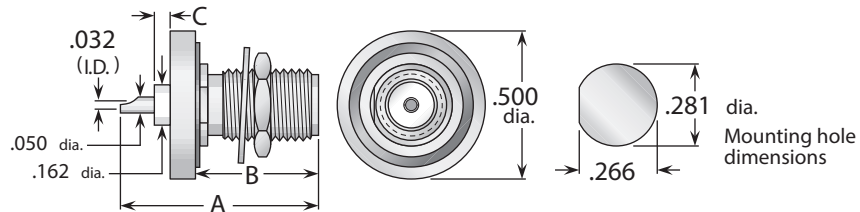

Figure 1 (Rear mount)

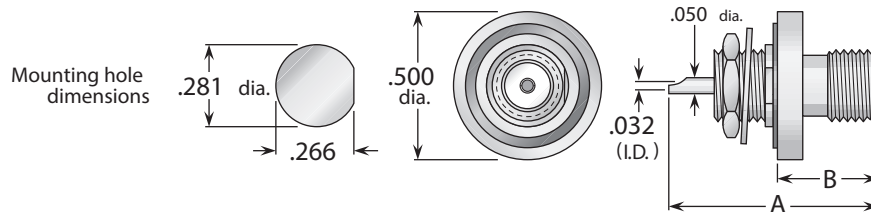

Figure 2 (Front mount)

M39012 P/N	Figure	Dimensions			Maximum Panel	Plating	
		A	B	C		Body	Contact
M39012/61-3001	1	.69	.415	.062	.103	Passivated	Gold (C)
M39012/61-3002	2	.69	.310	—	.103	Passivated	Gold (C)

(C) indicates captive contact.

M39012/25—TNC Dust Caps

Figure 1 (Cap for TNC plug)

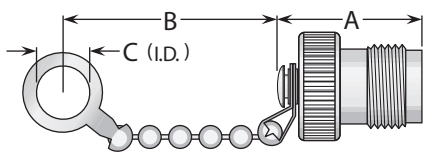

Figure 2 (Cap for TNC plug)

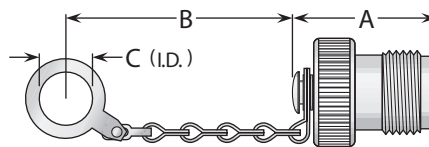

Figure 3 (Cap for TNC jack)

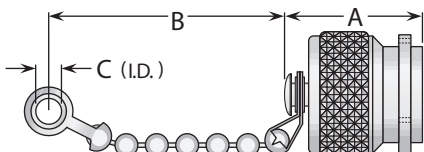
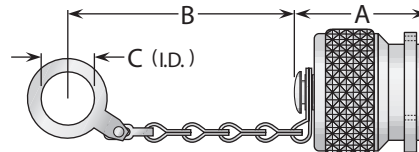

Figure 4 (Cap for TNC jack)



M39012 P/N	Figure	Dimensions			Chain Type	Plating	
		A	B	C		Body	Contact
M39012/25-0018	1	.68	3.25	.281	Bead	Silver	—
M39012/25-0019	2	.68	3.25	.281	Safety	Silver	—
M39012/25-0020	3	.70	2.25	.144	Bead	Silver	—
M39012/25-0021	4	.70	2.70	.515	Safety	Silver	—

M39012/26—TNC Straight Plug

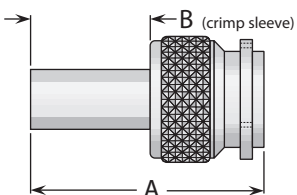

Figure 1

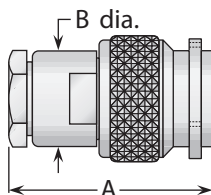
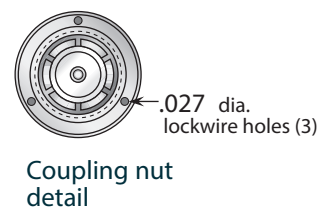

Figure 2



M39012 P/N	Category	Cable Group	Figure	Dimensions		Plating		Assembly Procedure/ Trim Code
				A	B	Body	Contact	
M39012/26-0010	C	VIA	1	1.10	.50	Silver	Gold (C)	B / 19
M39012/26-0011	C	VIB	1	1.10	.50	Silver	Gold (C)	B / 19
M39012/26-0012	C	VIIA	1	1.10	.50	Silver	Gold (C)	B / 19
M39012/26-0013	C	IV	1	1.10	.50	Silver	Gold (C)	B / 19
M39012/26-0014	C	VIIB	1	1.10	.50	Silver	Gold (C)	B / 19
M39012/26-0018	A	II	2	1.06	.50	Silver	Gold (C)	A / 17
M39012/26-0022	C	IIA	1	1.04	.44	Silver	Gold (C)	Contact Factory
M39012/26-0023	C	V	1	1.10	.50	Silver	Gold (C)	B / 19
M39012/26-0101	A	VI	2	1.06	.50	Silver	Gold (C)	A / 17
M39012/26-0102	A	VII	2	1.06	.50	Silver	Gold (C)	A / 17
M39012/26-0103	A	IV	2	1.06	.50	Silver	Gold (C)	A / 17

See page 2 for cable groups and category definitions. • Assembly procedures start on page 20. • (C) indicates captive contact.

M39012/27—TNC Straight Jack

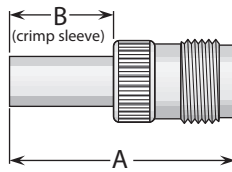

Figure 1

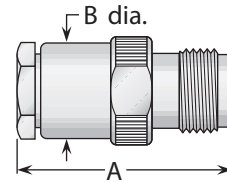

Figure 2

M39012 P/N	Category	Cable Group	Figure	Dimensions		Plating		Assembly Procedure/ Trim Code
				A	B	Body	Contact	
M39012/27-0010	C	VIA	1	1.19	.50	Silver	Gold (C)	B / 19
M39012/27-0011	C	VIB	1	1.19	.50	Silver	Gold (C)	B / 19
M39012/27-0012	C	VIIA	1	1.19	.50	Silver	Gold (C)	B / 19
M39012/27-0013	C	IV	1	1.19	.50	Silver	Gold (C)	B / 19
M39012/27-0014	C	VIIB	1	1.19	.50	Silver	Gold (C)	B / 19
M39012/27-0018	A	II	2	1.16	.50	Silver	Gold (C)	A / 17
M39012/27-0022	C	IIA	1	1.13	.44	Silver	Gold (C)	Contact Factory
M39012/27-0023	C	V	1	1.19	.50	Silver	Gold (C)	B / 19
M39012/27-0101	A	VI	2	1.16	.50	Silver	Gold (C)	A / 17
M39012/27-0102	A	VII	2	1.16	.50	Silver	Gold (C)	A / 17
M39012/27-0103	A	IV	2	1.16	.50	Silver	Gold (C)	A / 17

M39012/28—TNC Bulkhead Jack

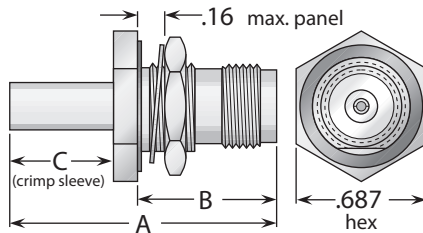

Figure 1

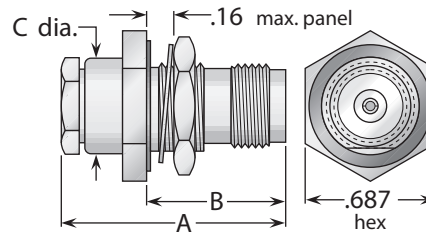
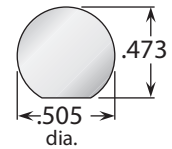

Figure 2



Mounting hole dimensions

M39012 P/N	Category	Cable Group	Figure	Dimensions			Plating		Assembly Procedure/ Trim Code
				A	B	C	Body	Contact	
M39012/28-0010	C	VIA	1	1.43	.81	.50	Silver	Gold (C)	B / 19
M39012/28-0011	C	VIB	1	1.43	.81	.50	Silver	Gold (C)	B / 19
M39012/28-0012	C	VIIA	1	1.43	.81	.50	Silver	Gold (C)	B / 19
M39012/28-0013	C	IV	1	1.43	.81	.50	Silver	Gold (C)	B / 19
M39012/28-0014	C	VIIB	1	1.43	.81	.50	Silver	Gold (C)	B / 19
M39012/28-0018	A	II	2	1.16	.81	.50	Silver	Gold (C)	A / 17
M39012/28-0022	C	IIA	1	1.37	.81	.44	Silver	Gold (C)	Contact Factory
M39012/28-0023	C	V	1	1.43	.81	.50	Silver	Gold (C)	B / 19
M39012/28-0101	A	VI	2	1.16	.81	.50	Silver	Gold (C)	A / 17
M39012/28-0102	A	VII	2	1.16	.81	.50	Silver	Gold (C)	A / 17
M39012/28-0103	A	IV	2	1.16	.81	.50	Silver	Gold (C)	A / 17

See page 2 for cable groups and category definitions. • Assembly procedures start on page 20. • (C) indicates captive contact.

M39012/29—TNC Panel Jack

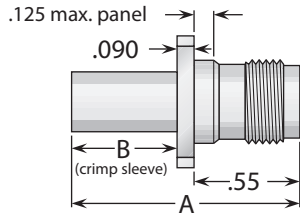

Figure 1

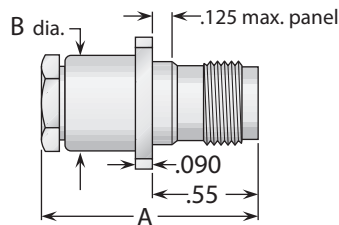
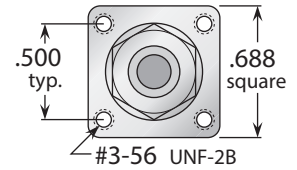

Figure 2



Flange dimensions

M39012 P/N	Category	Cable Group	Figure	Dimensions		Plating		Assembly Procedure/ Trim Code
				A	B	Body	Contact	
M39012/29-0010	C	VIA	1	1.17	.50	Silver	Gold (C)	B / 19
M39012/29-0011	C	VIB	1	1.17	.50	Silver	Gold (C)	B / 19
M39012/29-0012	C	VIIA	1	1.43	.50	Silver	Gold (C)	B / 19
M39012/29-0013	C	IV	1	1.17	.50	Silver	Gold (C)	B / 19
M39012/29-0014	C	VIIIB	1	1.17	.50	Silver	Gold (C)	B / 19
M39012/29-0018	A	II	2	1.16	.50	Silver	Gold (C)	A / 17
M39012/29-0022	C	IIA	1	1.13	.44	Silver	Gold (C)	Contact Factory
M39012/29-0023	C	V	1	1.17	.50	Silver	Gold (C)	B / 19
M39012/29-0101	A	VI	2	1.16	.50	Silver	Gold (C)	A / 17
M39012/29-0102	A	VII	2	1.16	.50	Silver	Gold (C)	A / 17
M39012/29-0103	A	IV	2	1.16	.50	Silver	Gold (C)	A / 17

M39012/31—TNC Bulkhead Receptacle

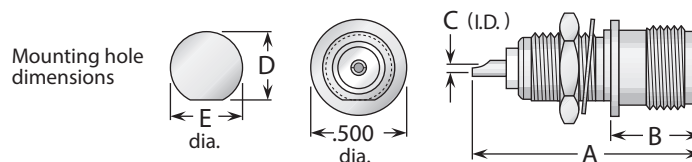

Figure 1

M39012 P/N	Figure	Dimensions					Maximum Panel	Plating	
		A	B	C	D	E		Body	Contact
M39012/31-0001	1	1.06	.47	.062	.410	.442	.13	Silver	Gold (C)
M39012/31-0002	1	1.19	.47	.062	.348	.380	.25	Silver	Gold (C)

(C) indicates captive contact.

M39012/32—TNC Panel Receptacle

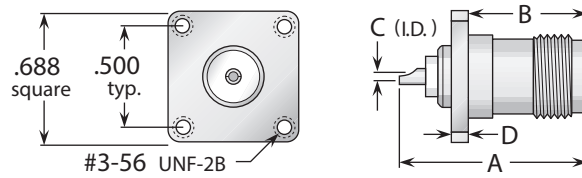

Figure 1

M39012 P/N	Figure	Dimensions				Maximum Panel	Plating	
		A	B	C	D		Body	Contact
M39012/32-0001	1	1.06	.63	.062	.090	.125	Silver	Gold (C)

M39012/34—TNC Bulkhead Receptacle (Hermetically Sealed)

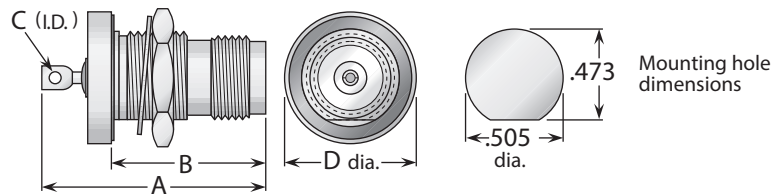

Figure 1
(Rear mount)

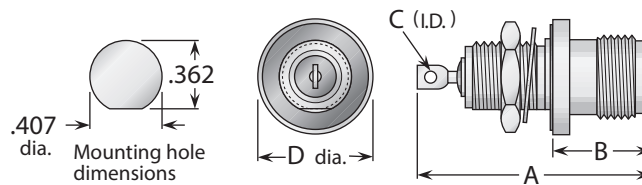

Figure 2
(Front Mount)

M39012 P/N	Figure	Dimensions				Maximum Panel	Plating	
		A	B	C	D		Body	Contact
M39012/34-0001	1	1.20	.83	.062	.687	.25	Silver	Gold (C)
M39012/34-0002	2	1.20	.52	.062	.594	.25	Silver	Gold (C)

(C) indicates captive contact.

M55339—Adapters Between Series

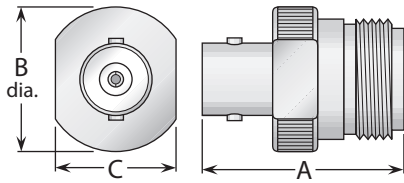

Figure 1 (BNC jack—N jack)

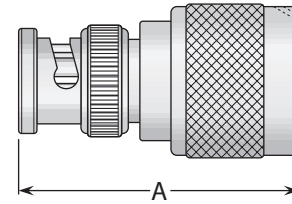

Figure 2 (BNC plug—N plug)

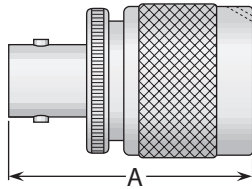

Figure 3 (BNC jack—N plug)

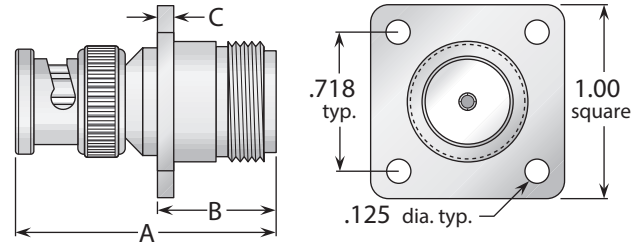

Figure 4
(BNC plug—N jack, panel mounted)

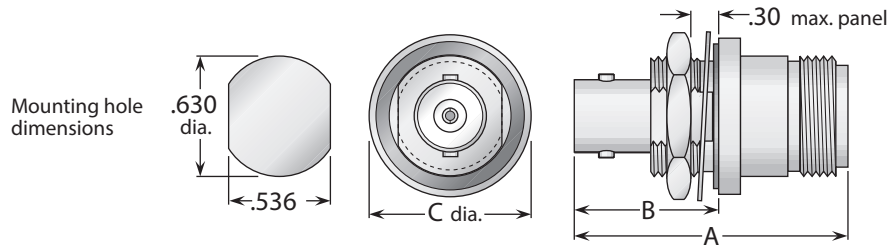

Figure 5
(BNC jack—N jack, bulkhead mounted, pressurized)

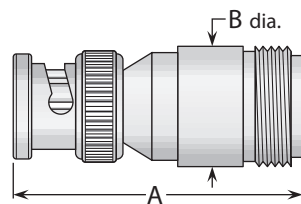

Figure 6 (BNC plug—N jack)

M55339 P/N	Figure	Dimensions			Plating	
		A	B	C	Body	Contact
M55339/01-00001	1	1.13	.75	.625	Silver	Gold (C)
M55339/18-01034	2	1.48	—	—	Silver	Gold (C)
M55339/20-00201	3	1.31	—	—	Silver	Gold (C)
M55339/24-00335	4	1.47	.736	.080	Silver	Gold (C)
M55339/25-00606	5	1.75	1.026	.812	Silver	Gold (C)
M55339/49-00349	6	1.47	.625	—	Silver	Gold (C)

(C) indicates captive contact.

Assembly Procedure A

Cable Trim Codes			
Code	A	B	C
A/01	.375	.047	.203
A/07	.375	.047	.125
A/17	.375	.109	.125
A/37	.281	.038	.188
A/38	.281	.069	.156

- 1) Trim cable jacket to dimension A. Slide backnut, washer, V-gasket, and braid clamp onto cable as shown. Cable jacket should bottom on step inside braid clamp.

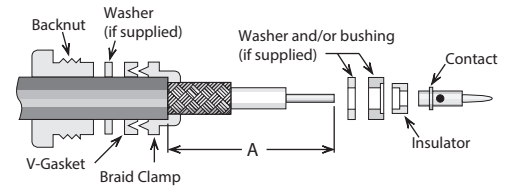

- 2) Comb braid wires out straight and fold back over front shoulder of braid clamp (braid wires should not overlap after folding). Trim braid wires flush with step of braid clamp. Trim cable dielectric and center conductor to dimensions B and C.

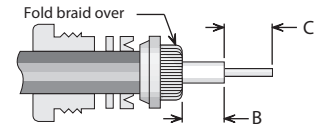

- 3) If support insulator is provided for RG-62 or 71 cable, insert into hollow in dielectric. Assemble rear bushing or washer (if supplied), rear insulator, and contact, and solder contact to center conductor. Rear of contact should be flush with cable dielectric end.

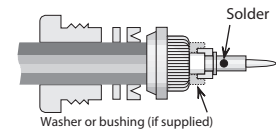

- 4) Insert prepared cable and hardware into body and tighten backnut.

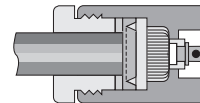

Assembly Procedure B

Cable Trim Codes			
Code	A	B	C
B/03	.406	.500	.187
B/10	.280	.436	.187
B/19	.343	.437	.156
B/40	.281	.390	.140

- 1) Trim cable per chart. Slide crimp sleeve back onto cable.

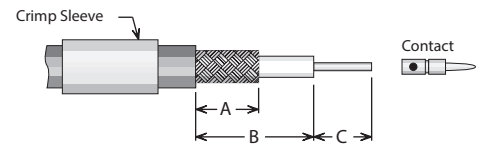

- 2) If support insulator is provided for RG-62 or 71 cable, insert into hollow in dielectric. Solder or crimp contact onto center conductor; back of contact flush with trimmed end of cable dielectric. Flare cut end of braid slightly by rotating dielectric.

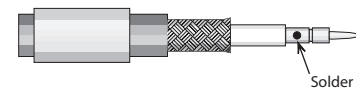

- 3) Insert cable/contact into rear of body, with all braid wires on outside of crimp tail. Push cable in until contact snaps into insulator. Slide crimp sleeve forward until flush with body and crimp (see page 20 for hex die sizes).

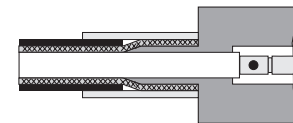

Assembly Procedure K

Cable Trim Codes			
Code	A	B	C
K/12	.281	.390	.140

- 1) Trim cable per chart. Slide crimp (or solder) sleeve onto cable.

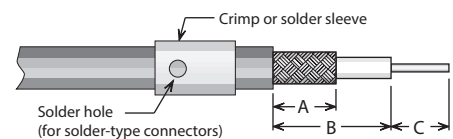

- 2) Solder contact onto center conductor, fixturing to maintain gap as shown. Flare cut end of braid slightly by rotating dielectric.

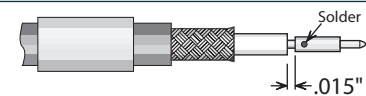

- 3) Insert cable/contact into rear of body, with all braid wires on outside of crimp tail. Push cable in until cable dielectric bottoms in connector. Slide crimp sleeve forward until flush with body and crimp (see page 20 for hex die sizes). (For solder-type connectors, solder braid to body and sleeve through hole in sleeve.)

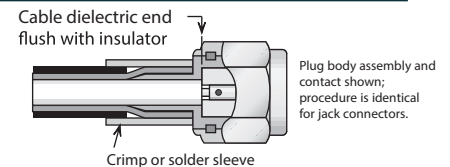

Assembly Procedure L

Cable Trim Codes			
Code	A	B	C
L/01	.250	.438	.109
L/06	.281	.390	.070

- 1) Trim cable per chart. Slide crimp (or solder) sleeve onto cable.

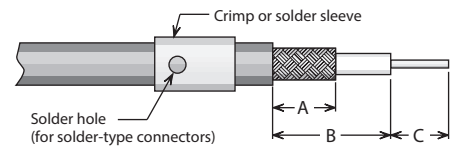

- 2) Insert cable into rear of body, with all braid wires on outside of crimp tail. Push cable in until end of braid touches connector body shoulder and center conductor rests in contact slot.

Slide crimp sleeve forward until flush with body and crimp (see page 20 for hex die sizes). (For solder-type connectors, solder braid to body and sleeve through hole in sleeve.)

Solder center conductor into contact slot, assemble insulator disc (if supplied), then press cap into body until seated or screw into place.

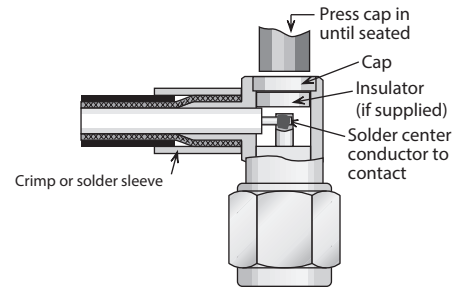

Assembly Procedure M

Cable Trim Codes			
Code	A	B	C
M/01	.281	.390	.140

- 1) Trim cable per chart. Slide crimp (or solder) sleeve and backnut onto cable.

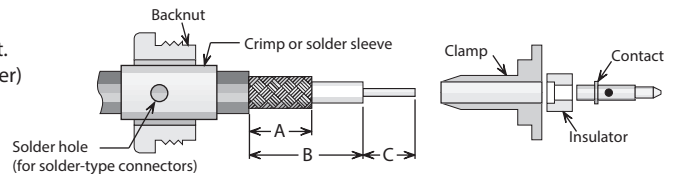

- 2) Flare cut end of braid slightly by rotating dielectric. Insert cable into rear of clamp, with all braid wires on outside of crimp tail. Slide insulator over cable dielectric until it is flush with front of clamp, and cable insulation bottoms inside insulator. Slide contact onto center conductor, with contact shoulder flush with front of insulator. Solder contact to center conductor.

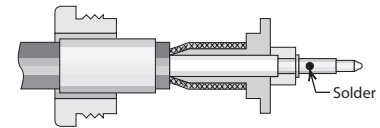

- 3) Slide crimp sleeve forward until flush with clamp shoulder; crimp as close to shoulder as possible. (see page 20 for hex die sizes). (For solder-type connectors, solder braid to body and sleeve through hole in sleeve.)

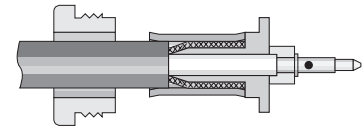

- 4) Insert prepared cable into back of body. Slide nut forward and tighten to 12-15 inch-pounds.

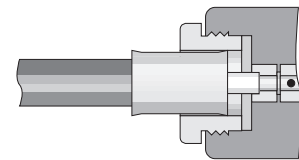

Crimp Tools for Flexible Cable



Frame only—P/N M22520/5-01 —Use with interchangeable dies listed below.

Hex Die Size	Die Set P/N	Closure
.429 hex, .400 wide	M22520/5-61	A
.213 hex, .400 wide	M22520/5-19	B
.255 hex, .400 wide	M22520/5-19	A
.128 hex, .400 wide	M22520/5-35	B
.151 hex, .400 wide	M22520/5-37	B
.105 hex, .400 wide	M22520/5-33	B



CREATE

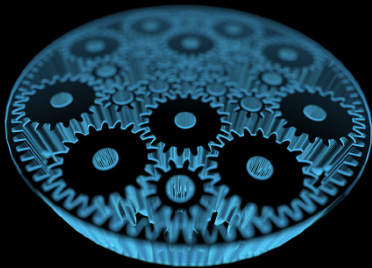

COLLABORATE

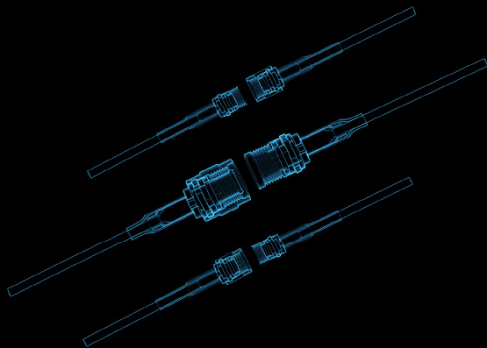

CONNECT



Delta Electronics Mfg. Corp.

www.deltarf.com
978-927-1060
sales@deltarf.com

PO Box 53
416 Cabot St.
Beverly, MA 01915

